

Specifications

Rating:	12A 300V
Contact Resistance:	20mΩ Max
Insulation Resistance:	5000MΩ Min
Dielectric Strength:	1500VAC 1 minute
Housing Material:	PA66 UL94V-0
Contact Material:	Tin Plated Brass
Wire Range:	16-26AWG
Operating Temperature:	-40°C to +105°C

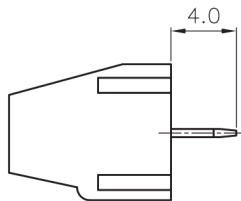

STRAIGHT TYPE

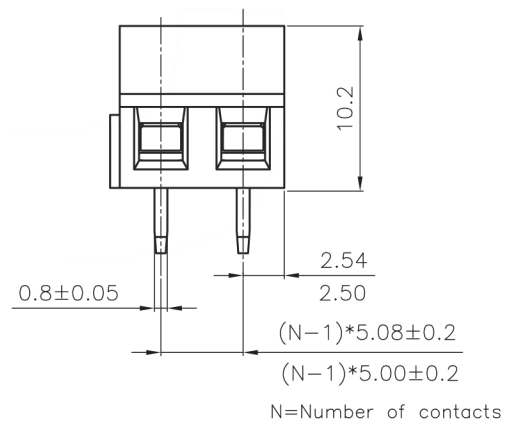
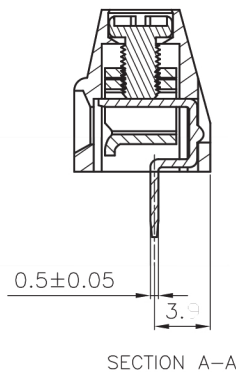
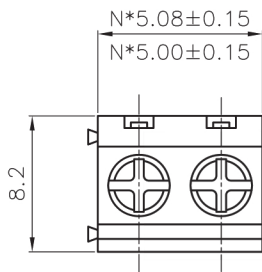
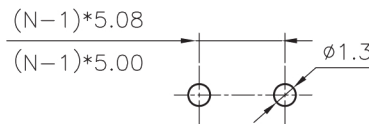

RECOMMEND PCB LAYOUT
(TOLERANCE=±0.05)

Description	Ref Code
3-Way Terminal Block 5.08mm Pitch 12A	551777