

Specifications

Rated Voltage:	9VDC
Max Rated Current:	25mA
Resonant Frequency:	400Hz
Sound Output:	75dB @ 20cm
Operating Temperature:	-20°C to +60°C

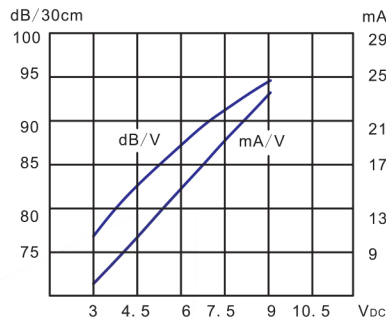
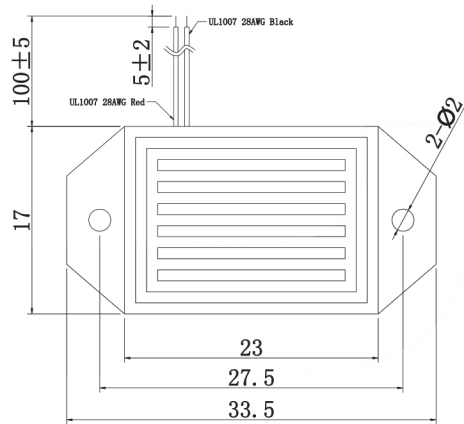
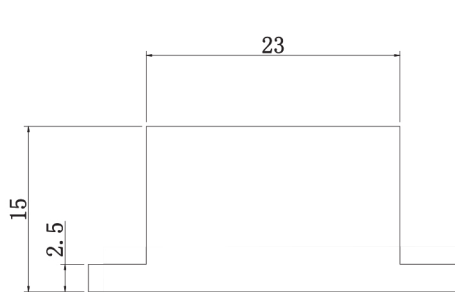

Description	Ref Code
9V Electronic Buzzer with Flying Leads	551667