

Specifications

Rating:	5A 250VAC
Operating Force:	4.5N Max
Contact Resistance:	50mΩ Max
Insulation Resistance:	100MΩ Min
Electrical Life:	50,000+ Cycles

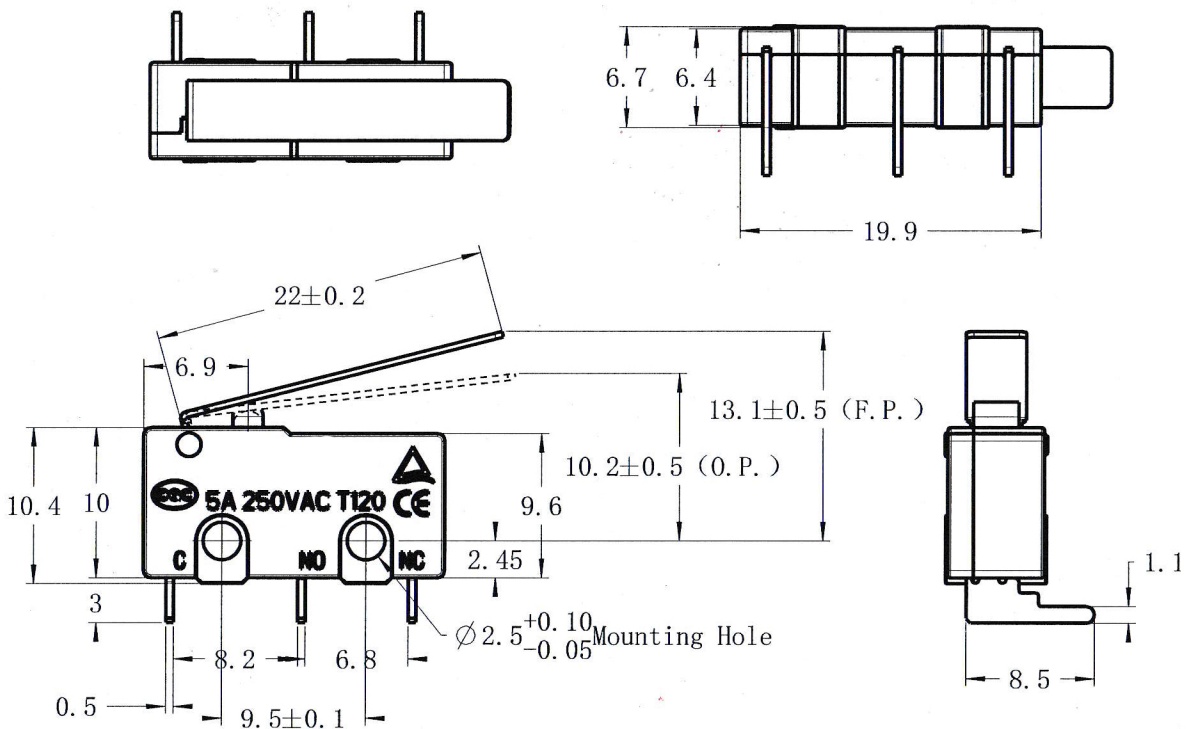

Description	Ref Code
22mm Lever Horizontal PCB V4 Miniature Microswitch SPDT 5A	483510