

Specifications

Rating:	0.5A 125VAC, 0.3A 250VAC
Contact Resistance:	20mΩ Max
Insulation Resistance:	100MΩ Min
Dielectric Strength:	1000VAC 1 minute
Operating Temperature:	-25°C to +85°C
Electrical Life:	20,000+ Cycles

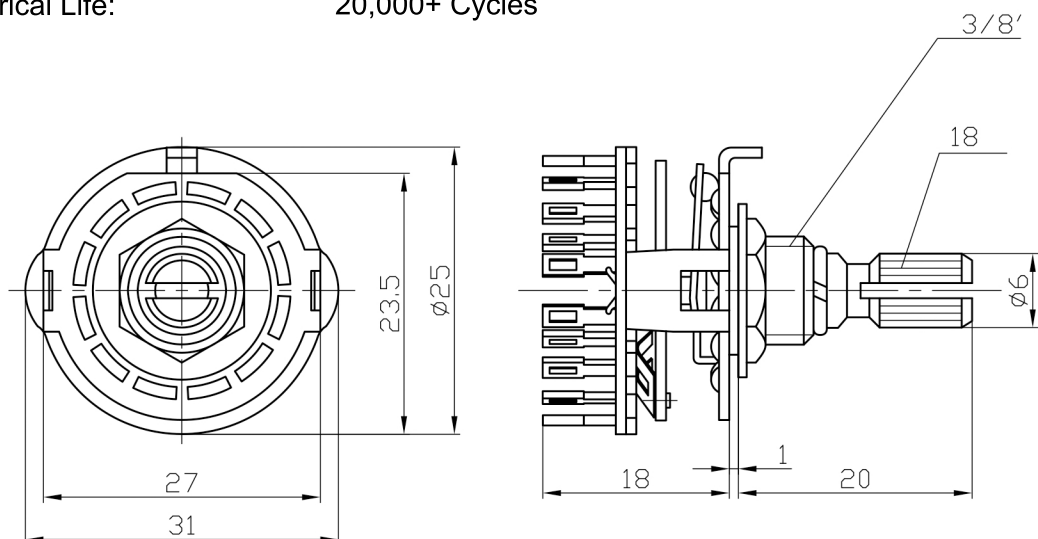

Mounting

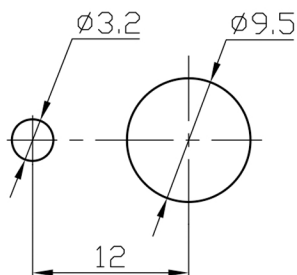

Description	Ref Code
3 Pole 4 Way Rotary Switch 6mm Actuator	483322