

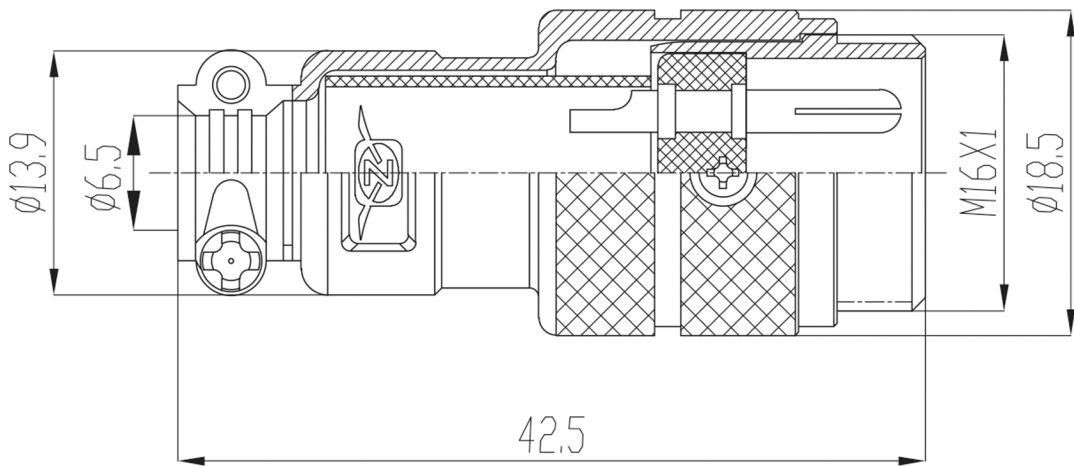









Specifications

Rating:	7A 125VAC
Contact Resistance:	10mΩ
Insulation Resistance:	2000MΩ Min
Dielectric Strength:	1500VAC 1 Min
Protection Level:	IP55
Solder Contact Diameter:	1.6mm



2P	3P	4P	5P	6P
				
7P	8P	9P	10P	
				

Description	Ref Code
2 Way M16 Male Circular Plug Connector	483248