

Specifications

Current Rating:	3A
Contact Material:	Tin Plated Bronze
Housing Material:	30% Glass Filled PPS UL94V-0
Contact Resistance:	10mΩ Max
Insulation Resistance:	1000MΩ Min at 100V DC
Operating Temperature:	-40°C to +105°C

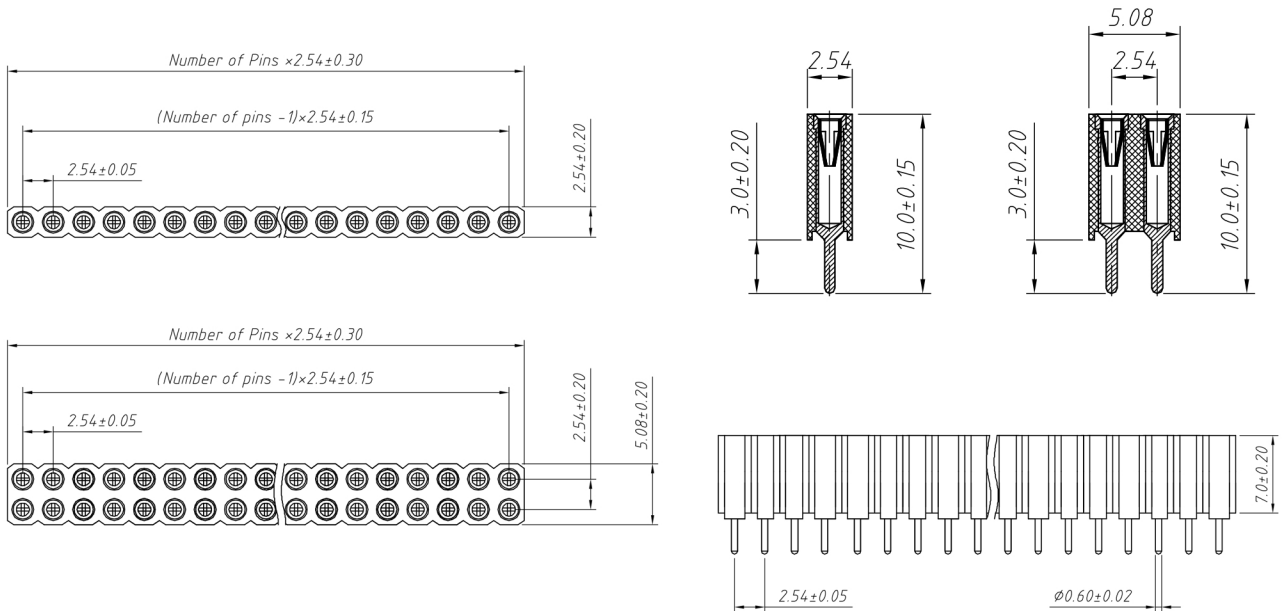

Description	Ref Code
2 Way 2.54mm Single In Line SIL Socket	483069