

Specifications

Contact Resistance:	30mΩ Max
Insulation Resistance:	50MΩ Min 500V DC
Withstand Voltage:	500VAC 1 minute
Housing Material:	PBT UL94V-0
Contact Material:	Brass
Operating Temperature:	-25°C to +85°C

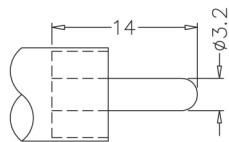

RCA MATE PLUG

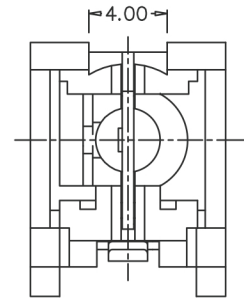
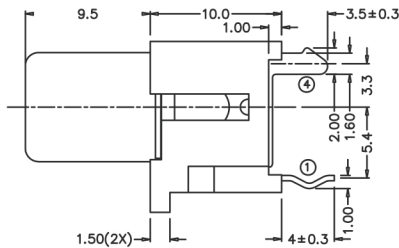
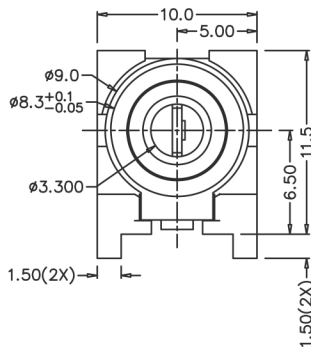
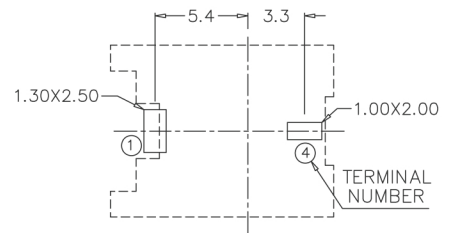
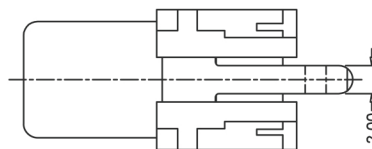

PCB LAYOUT
(BOTTOM VIEW)

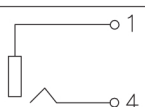
MODEL NO.	RCA-101
SCHEMATIC	

Description	Ref Code
Yellow RCA Vertical PCB Phono Socket	482653