

Specifications

Rating:	7A 125VAC
Contact Resistance:	10mΩ
Insulation Resistance:	2000MΩ Min
Dielectric Strength:	1500VAC 1 Min
Protection Level:	IP55
Solder Contact Diameter:	1.6mm

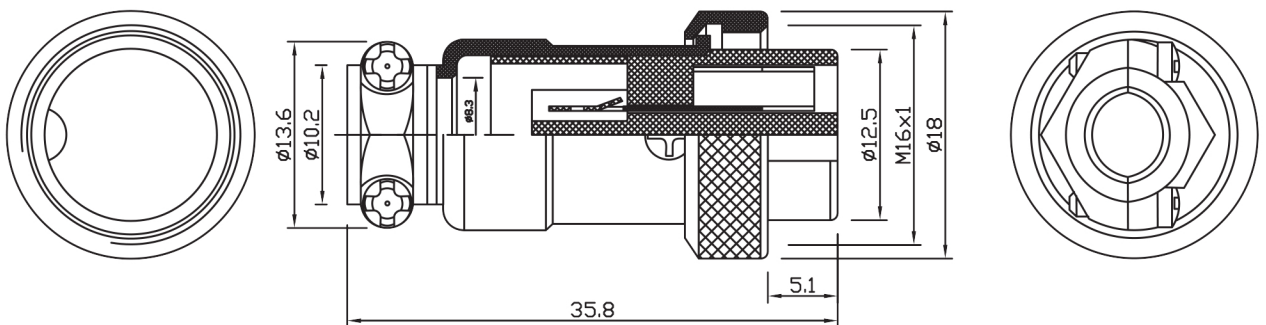

Description	Ref Code
4 Way Female M16 Metal Circular Connector Plug	482059