

Specifications

Rating:	3A 250VAC
Protection Level:	IP67
Operating Force:	85gf
Contact Resistance:	50mΩ Max
Insulation Resistance:	100MΩ Min 500VDC
Electrical Life:	100,000+ Cycles

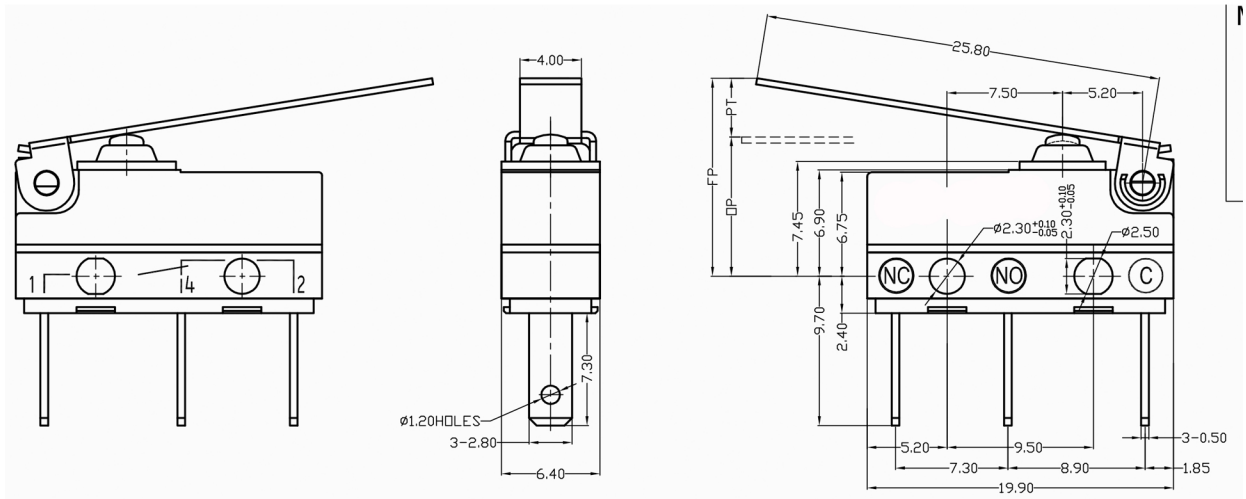

Circuit Diagram

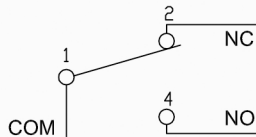

Mounting Hole Dimensions

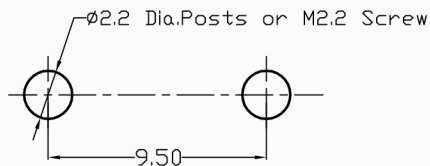

Description	Ref Code
26mm Lever Waterproof Microswitch SPDT 3A	481703