

Specifications

Current Rating:	3A
Contact Material:	Gold Plated Brass
Housing Material:	PA6T UL94V-0
Contact Resistance:	20mΩ Max
Insulation Resistance:	1000MΩ Min
Operating Temperature:	-40°C to +105°C

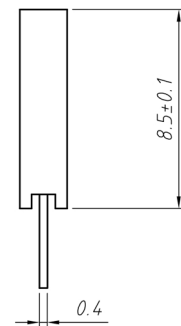
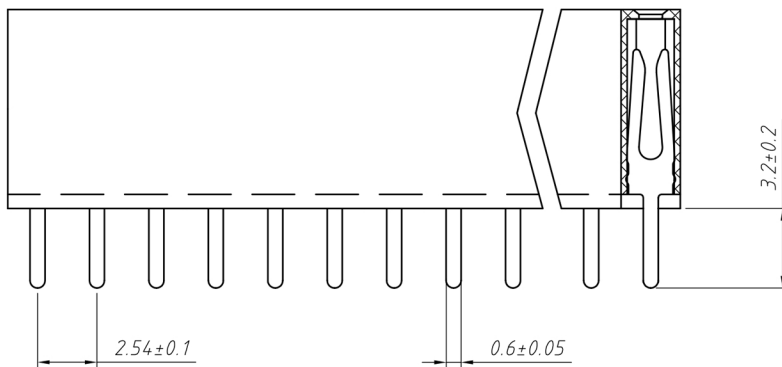
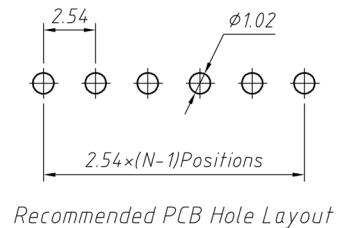
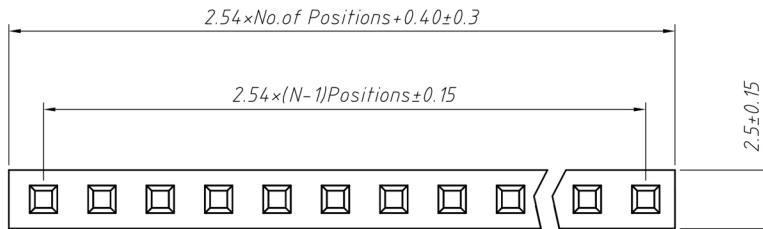

Description	Ref Code
4 Way Single Row PCB Socket 2.54mm	329016