



# Index

|    |                              |
|----|------------------------------|
| 2  | Introduction                 |
|    | Collections                  |
| 4  | New England                  |
| 14 | Quartzite                    |
| 22 | Chamonix                     |
| 30 | West 57th                    |
| 36 | Gotham                       |
| 42 | Nature                       |
| 48 | Essential                    |
| 56 | Pool Coping                  |
| 57 | Cleaning and Maintenance     |
| 58 | Technical Characteristics    |
| 60 | Mosaics and Muretto sizes    |
| 62 | Terms and conditions of sale |

# Indoor | Outdoor

The indoor and outdoor represent two worlds which are growing ever closer. Esthetic continuity, of color and texture, between the indoors and outdoors extends boundaries and spaces.

People are increasingly tending to bring the outdoors into their single open-plan living area. Contact with nature is seen as an improvement in personal wellbeing, and the 20 mm range facilitates the creation of a designer outdoor world. Only the indoor and outdoor surface is different to ensure the necessary safety outside as well as in.



Floor Indoor: New England HEN10 White 24"x48" | Floor Outdoor: New England2 HEN210 White 24"x24"



# New England

24"x48" 24"x24" 16"x32" 12"x24" 4"x12"

**Indoor** 8.5 mm

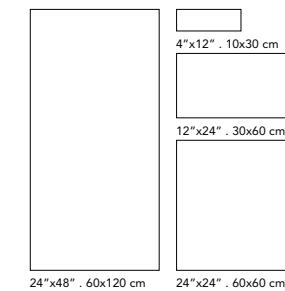

**Outdoor** 20 mm

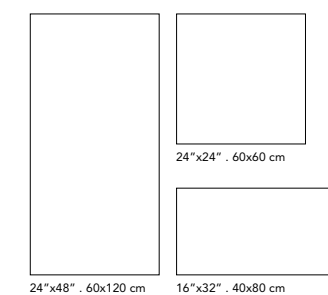

**Colored Body Porcelain Pavers and Stoneware**

**ANSI A 137.1 compliant**

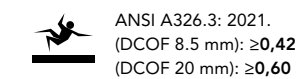
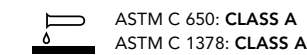
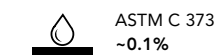
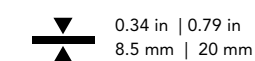
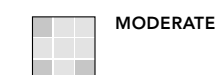

**New England** 

See all indoor colors on our website



**New England**  
HEN10 White - Indoor  
HEN210 White - Outdoor



**New England**  
HEN01 Ivory - Indoor  
HEN201 Ivory - Outdoor



**New England**  
HEN05 Cold Gray - Indoor  
HEN205 Cold Gray - Outdoor

**Graphics number**

| Sizes   | New England HEN10 White | New England HEN01 Ivory | New England HEN05 Cold Gray |
|---------|-------------------------|-------------------------|-----------------------------|
| 24"x48" | 10                      | 10                      | 10                          |
| 24"x24" | 20                      | 20                      | 20                          |
| 16"x32" | 20                      | 20                      | 20                          |
| 12"x24" | 40                      | 40                      | 40                          |

**Indoor Packaging**

| Sizes                      | Pieces | Sq.Ft. |       | Boxes  |         |
|----------------------------|--------|--------|-------|--------|---------|
|                            |        | Sq.Ft. | Lbs.  | Sq.Ft. | Lbs.    |
| 24"x48"                    | 2      | 15.50  | 61.00 | 36     | 2236.00 |
| 24"x24"                    | 6      | 23.25  | 91.50 | 24     | 2236.00 |
| 12"x24"                    | 8      | 15.50  | 61.40 | 32     | 1932.48 |
| 4"x12"                     | 36     | 11.65  | 46.45 | 40     | 1858.00 |
| 12"x12" mosaic             | 10     | 9.70   | -     | -      | -       |
| 12"x14" herringbone mosaic | 10     | 8.60   | -     | -      | -       |
| 12"x12" brick              | 10     | 9.70   | -     | -      | -       |
| 4"x24" bullnose            | 10     | -      | -     | -      | -       |

**Outdoor Packaging**

| Sizes               | Pieces | Sq.Ft. |       | Boxes  |         |
|---------------------|--------|--------|-------|--------|---------|
|                     |        | Sq.Ft. | Lbs.  | Sq.Ft. | Lbs.    |
| 24"x48"             | 1      | 7.75   | 73.22 | 26     | 1903.70 |
| 24"x24"             | 2      | 7.75   | 71.17 | 32     | 2277.30 |
| 16"x32"             | 2      | 6.89   | 64.66 | 24     | 1552.00 |
| 12"x24" pool coping | 2      | 3.87   | 35.58 | -      | -       |
| 16"x32" pool coping | 2      | 6.89   | 62.31 | -      | -       |

Stone Effect

# New England

24"x48" 24"x24" 16"x32" 12"x24" 4"x12"

HEN

Stone Effect



Stone Effect

# New England

24"x48" RECTIFIED - 24"x24" RECTIFIED - 12"x24" RECTIFIED - 4"x12" PRESSED

## Indoor



**G8EN10R**  
New England  
HEN10 White Rect.  
24"x48" . 60x120 cm



**30EN10**  
New England  
HEN10 White Rect.  
4"x12" . 10x30 cm



**G9EN10R**  
New England  
HEN10 White Rect.  
24"x24" . 60x60 cm



**G8EN10R**  
New England  
HEN10 White Rect.  
12"x24" . 30x60 cm



**G8EN10GRIR**  
New England  
HEN10 White **Grip** Rect.  
12"x24" . 30x60 cm



**G3EN10MO**  
New England  
HEN10 White Mosaic\*  
1 3/8" x 1 3/8" . 3,5x3,5 cm  
(sheet 12"x12" . 30x30 cm)



**G3EN10HB**  
New England  
HEN10 White Herringbone Mosaic\*  
1 7/8" x 3 7/8" . 4,7x9,7 cm  
(sheet 12"x14" . 31x35 cm)



**G3EN10BR**  
New England  
HEN10 White Brick\*  
1 7/8" x 3 7/8" . 4,7x9,7 cm  
(sheet 12"x12" 30x30 cm)



**G0EN10**  
New England  
HEN10 White Bullnose  
4"x24" . 10x60 cm

# New England 2

24"x48" RECTIFIED - 24"x24" PRESSED - 16"x32" PRESSED

## Outdoor



**SCEN10R** **MADE IN ITALY**  
New England2  
HEN210 White Rect.  
24"x48" . 60x120 cm



**S9EN10**  
New England2 HEN210 White  
24"x24" . 60x60 cm



**SOEN10**  
New England2 HEN210 White  
16"x32" . 40x80 cm



**G8EN10GRIR**  
New England  
HEN10 White **Grip** Rect.  
12"x24" . 30x60 cm  
0.34" - 8.5 mm thick



**SCEN10MC** **MADE IN ITALY**  
New England2 HEN210 White  
Pool Coping with modern edge  
24"x48" . 60x120 cm



**SOEN10MC**  
New England2 HEN210 White  
Pool Coping with modern edge  
16"x32" . 40x80 cm



**S8EN10MC**  
New England2 HEN210 White  
Pool Coping with modern edge  
12"x24" . 30x60 cm

# New England

24"x48" RECTIFIED - 24"x24" RECTIFIED - 12"x24" RECTIFIED - 4"x12" PRESSED

## Indoor



**G8EN01R**  
New England  
HEN01 Ivory Rect.  
24"x48" . 60x120 cm



**30EN01**  
New England  
HEN01 Ivory Rect.  
4"x12" . 10x30 cm



**G9EN01R**  
New England  
HEN01 Ivory Rect.  
24"x24" . 60x60 cm



**G8EN01R**  
New England  
HEN01 Ivory Rect.  
12"x24" . 30x60 cm

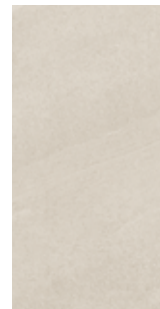

**G8EN01GRIR**  
New England  
HEN01 Ivory **Grip** Rect.  
12"x24" . 30x60 cm



**G3EN01MO**  
New England  
HEN01 Ivory Mosaic\*  
1 3/8" x 1 3/8" . 3,5x3,5 cm  
(sheet 12"x12" . 30x30 cm)



**G3EN01HB**  
New England  
HEN01 Ivory Herringbone Mosaic\*  
1 7/8" x 3 7/8" . 4,7x9,7 cm  
(sheet 12"x14" . 31x35 cm)



**G3EN01BR**  
New England  
HEN01 Ivory Brick\*  
1 7/8" x 3 7/8" . 4,7x9,7 cm  
(sheet 12"x12" 30x30 cm)



**GOEN01**  
New England  
HEN01 Ivory Bullnose  
4"x24" . 10x60 cm

# New England 2

24"x48" RECTIFIED - 24"x24" PRESSED - 16"x32" PRESSED

## Outdoor



**SCEN01R** **MADE IN ITALY**  
New England2 HEN201 Ivory Rect.  
24"x48" . 60x120 cm



**S9EN01**  
New England2 HEN201 Ivory  
24"x24" . 60x60 cm



**SOEN01**  
New England2 HEN201 Ivory  
16"x32" . 40x80 cm



**G8EN01GRIR**  
New England  
HEN01 Ivory **Grip** Rect.  
12"x24" . 30x60 cm  
0.34" - 8.5 mm thick



**SCEN01MC** **MADE IN ITALY**  
New England2 HEN201 Ivory  
Pool Coping with modern edge  
24"x48" . 60x120 cm



**SOEN01MC**  
New England2 HEN201 Ivory  
Pool Coping with modern edge  
16"x32" . 40x80 cm



**S8EN01MC**  
New England2 HEN201 Ivory  
Pool Coping with modern edge  
12"x24" . 30x60 cm

# New England

24"x48" RECTIFIED - 24"x24" RECTIFIED - 12"x24" RECTIFIED - 4"x12" PRESSED

## Indoor



**G3EN05R**  
New England  
HEN05 Cold Gray Rect.  
24"x48" . 60x120 cm



**30EN05**  
New England  
HEN05 Cold Gray Rect.  
4"x12" . 10x30 cm



**G9EN05R**  
New England  
HEN05 Cold Gray Rect.  
24"x24" . 60x60 cm



**G8EN05R**  
New England  
HEN05 Cold Gray Rect.  
12"x24" . 30x60 cm



**G8EN05GRIR**  
New England  
HEN05 Cold Gray **Grip** Rect.  
12"x24" . 30x60 cm



**G3EN05MO**  
New England  
HEN05 Cold Gray Mosaic\*  
1 3/8"x 1 3/8" . 3,5x3,5 cm  
(sheet 12"x12" . 30x30 cm)



**G3EN05HB**  
New England  
HEN05 Cold Gray Herringbone Mosaic\*  
1 7/8"x 3 7/8" . 4,7x9,7 cm  
(sheet 12"x14" . 31x35 cm)



**G3EN05HB**  
New England  
HEN05 Cold Gray Herringbone Mosaic\*  
1 7/8"x 3 7/8" . 4,7x9,7 cm  
(sheet 12"x14" . 31x35 cm)



**GOEN05**  
New England  
HEN05 Cold Gray Bullnose  
4"x24" . 10x60 cm

# New England 2

PRESSED COLLECTION

## Outdoor



**S9EN05**  
New England2 HEN205 Cold Gray  
24"x24" . 60x60 cm



**SOEN05**  
New England2 HEN205 Cold Gray  
16"x32" . 40x80 cm



**G8EN05GRIR**  
New England  
HEN05 Cold Gray **Grip** Rect.  
12"x24" . 30x60 cm  
0.34" - 8.5 mm thick



**SOEN05MC**  
New England2 HEN205 Cold Gray  
Pool Coping with modern edge  
16"x32" . 40x80 cm



**S8EN05MC**  
New England2 HEN205 Cold Gray  
Pool Coping with modern edge  
12"x24" . 30x60 cm

Stone Effect

Stone Effect





# Quartzite

24"x48" 12"x48" 16"x32" 12"x24" 4"x12"

**Indoor** 8.5 mm

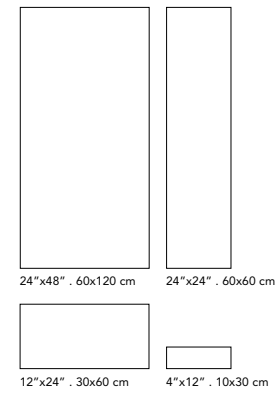

**Outdoor** 20 mm

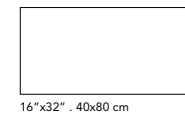

Colored Body Porcelain Pavers and Stoneware

ANSI A 137.1 compliant

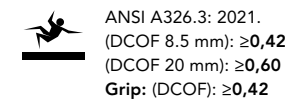
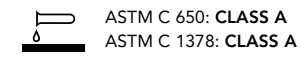
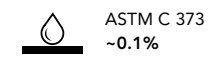
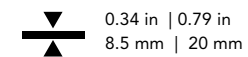
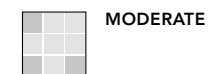

**Quartzite**  
HQT10 Bianco - Indoor  
HQT210 Bianco - Outdoor



**Quartzite**  
HQT01 Sand - Indoor  
HQT201 Sand - Outdoor



**Quartzite**  
HQT05 Gray - Indoor  
HQT205 Gray - Outdoor



**Quartzite**  
HQT08 Dark Gray - Indoor  
HQT208 Dark Gray - Outdoor

Graphics number

| Sizes   | Quartzite HQT10 Bianco | Quartzite HQT01 Sand | Quartzite HQT05 Gray | Quartzite HQT08 Dark Gray |
|---------|------------------------|----------------------|----------------------|---------------------------|
| 24"x48" | 8                      | 8                    | 8                    | 8                         |
| 12"x48" | 16                     | 16                   | 16                   | 16                        |
| 16"x32" | 12                     | 12                   | 12                   | 12                        |
| 12"x24" | 32                     | 32                   | 32                   | 32                        |

Indoor Packaging

| Sizes                | Pieces | Sq.Ft. | Lbs.  | Boxes | Sq.Ft. | Lbs.    |
|----------------------|--------|--------|-------|-------|--------|---------|
| 24"x48"              | 2      | 15.50  | 61.00 | 36    | 558.00 | 2236.00 |
| 12"x48"              | 3      | 11.62  | 45.75 | 54    | 627.75 | 2340.00 |
| 12"x24"              | 8      | 15.50  | 61.40 | 32    | 496.00 | 1932.48 |
| 4"x12"               | 36     | 11.65  | 46,45 | 40    | 466.00 | 1858.00 |
| 12"x12" mosaic       | 10     | 9.70   | -     | -     | -      | -       |
| 12"x12" muretto wall | 10     | 9.70   | -     | -     | -      | -       |
| 4"x24" bullnose      | 10     | -      | -     | -     | -      | -       |

Outdoor Packaging

| Sizes               | Pieces | Sq.Ft. | Lbs.  | Boxes | Sq.Ft. | Lbs.    |
|---------------------|--------|--------|-------|-------|--------|---------|
| 16"x32"             | 2      | 6.89   | 64.66 | 24    | 165.36 | 1552.00 |
| 16"x32" pool coping | 2      | 6.89   | 62.31 | -     | -      | -       |

# Quartzite

24"x48" 12"x48" 16"x32" 12"x24" 4"x12"

HOT



Stone Effect

Stone Effect

# Quartzite

RECTIFIED COLLECTION

## Indoor



**GCQT10R**  
Quartzite HQT10 Bianco Rect.  
24"x48" . 60x120 cm



**GMQT10R**  
Quartzite HQT10 Bianco Rect.  
12"x48" . 30x120 cm



**G8QT10R**  
Quartzite HQT10 Bianco Rect.  
12"x24" . 30x60 cm



**30QT10**  
Quartzite HQT10 Bianco Rect.  
4"x12" . 10x30 cm



**G8QT10GRIR**  
Quartzite  
HQT10 Bianco **Grip** Rect.  
12"x24" . 30x60 cm

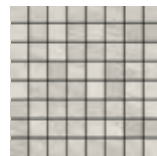

**G3QT10MO**  
Quartzite  
HQT10 Bianco Mosaic\*  
(sheet 12"x12" . 30x30 cm)



**G0QT10**  
Quartzite  
HQT10 Bianco Bullnose  
4"x24" . 10x60 cm



**G3QT10MU**  
Quartzite  
HQT10 Bianco Muretto Wall\*  
(sheet 12"x12" . 30x30 cm)

Stone Effect

# Quartzite 2

PRESSED COLLECTION

## Outdoor

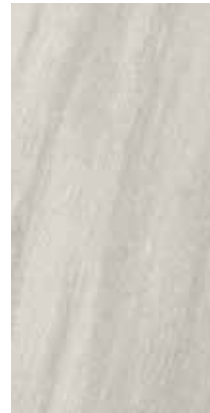

**SOQT10**  
Quartzite2 HQT210 Bianco  
16"x32" . 40x80 cm



**G8QT10GRIR**  
Quartzite  
HQT10 Bianco **Grip** Rect.  
12"x24" . 30x60 cm  
0.34" - 8.5 mm thick



**SOQT10MC**  
Quartzite2 HQT210 Bianco  
Pool Coping with modern edge  
16"x32" . 40x80 cm

\*More details on page. 60

# Quartzite

RECTIFIED COLLECTION

## Indoor



**GCQT01R**  
Quartzite HQT01 Sand Rect.  
24"x48" . 60x120 cm



**GMQT01R**  
Quartzite HQT01 Sand Rect.  
12"x48" . 30x120 cm



**G8QT01R**  
Quartzite HQT01 Sand Rect.  
12"x24" . 30x60 cm



**30QT01**  
Quartzite HQT01 Sand Rect.  
4"x12" . 10x30 cm



**G8QT01GRIR**  
Quartzite  
HQT01 Sand **Grip** Rect.  
12"x24" . 30x60 cm

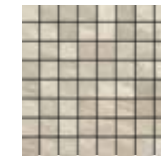

**G3QT01MO**  
Quartzite  
HQT01 Sand Mosaic\*  
(sheet 12"x12" . 30x30 cm)



**G0QT01**  
Quartzite  
HQT01 Sand Bullnose  
4"x24" . 10x60 cm



**G3QT01MU**  
Quartzite  
HQT01 Sand Muretto Wall\*  
(sheet 12"x12" . 30x30 cm)

Stone Effect

# Quartzite 2

PRESSED COLLECTION

## Outdoor



**SOQT01**  
Quartzite2 HQT201 Sand  
16"x32" . 40x80 cm



**G8QT01GRIR**  
Quartzite  
HQT01 Sand **Grip** Rect.  
12"x24" . 30x60 cm  
0.34" - 8.5 mm thick



**SOQT01MC**  
Quartzite2 HQT201 Sand  
Pool Coping with modern edge  
16"x32" . 40x80 cm

\*More details on page. 60

# Quartzite

RECTIFIED COLLECTION

## Indoor



**GCQT05R**  
Quartzite HQT05 Gray Rect.  
24"x48" . 60x120 cm



**GMQT05R**  
Quartzite HQT05 Gray Rect.  
12"x48" . 30x120 cm



**G8QT05R**  
Quartzite HQT05 Gray Rect.  
12"x24" . 30x60 cm



**30QT05**  
Quartzite HQT05 Gray Rect.  
4"x12" . 10x30 cm



**G8QT05GRIR**  
Quartzite  
HQT05 Gray **Grip** Rect.  
12"x24" . 30x60 cm

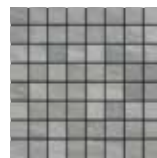

**G3QT05MO**  
Quartzite  
HQT05 Gray Mosaic\*  
(sheet 12"x12" . 30x30 cm)



**G0QT05**  
Quartzite  
HQT05 Gray Bullnose  
4"x24" . 10x60 cm



**G3QT05MU**  
Quartzite  
HQT05 Gray Muretto Wall\*  
(sheet 12"x12" . 30x30 cm)

# Quartzite 2

PRESSED COLLECTION

## Outdoor

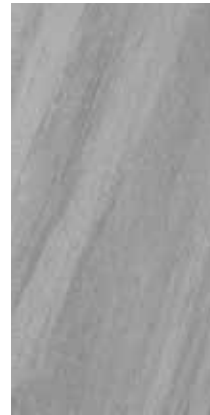

**SOQT05**  
Quartzite2 HQT205 Gray  
16"x32" . 40x80 cm



**G8QT05GRIR**  
Quartzite  
HQT05 Gray **Grip** Rect.  
12"x24" . 30x60 cm  
0.34" - 8.5 mm thick



**SOQT05MC**  
Quartzite2 HQT205 Gray  
Pool Coping with modern edge  
16"x32" . 40x80 cm

# Quartzite

RECTIFIED COLLECTION

## Indoor



**GCQT08R**  
Quartzite HQT08 Dark Gray Rect.  
24"x48" . 60x120 cm



**GMQT08R**  
Quartzite HQT08 Dark Gray Rect.  
12"x48" . 30x120 cm



**G8QT08R**  
Quartzite HQT08 Dark Gray Rect.  
12"x24" . 30x60 cm



**30QT08**  
Quartzite HQT08 Dark Gray Rect.  
4"x12" . 10x30 cm



**G8QT08GRIR**  
Quartzite  
HQT08 Dark Gray **Grip** Rect.  
12"x24" . 30x60 cm



**G3QT08MO**  
Quartzite  
HQT08 Dark Gray Mosaic\*  
(sheet 12"x12" . 30x30 cm)



**G0QT08**  
Quartzite  
HQT08 Dark Gray Bullnose  
4"x24" . 10x60 cm



**G3QT08MU**  
Quartzite  
HQT08 Dark Gray Muretto Wall\*  
(sheet 12"x12" . 30x30 cm)

# Quartzite 2

PRESSED COLLECTION

## Outdoor



**SOQT08**  
Quartzite2 HQT208 Dark Gray  
16"x32" . 40x80 cm



**G8QT08GRIR**  
Quartzite  
HQT08 Dark Gray **Grip** Rect.  
12"x24" . 30x60 cm  
0.34" - 8.5 mm thick



**SOQT08MC**  
Quartzite2 HQT208 Dark Gray  
Pool Coping with modern edge  
16"x32" . 40x80 cm



# Chamonix

24"x48" 24"x24" 12"x24"

**Indoor** 8.5 mm

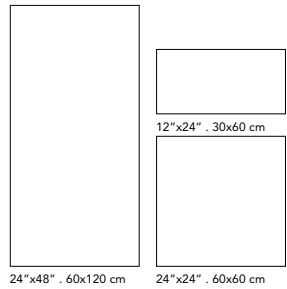

**Outdoor** 20 mm

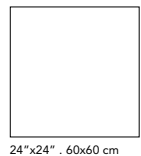

Colored Body Porcelain Pavers and Stoneware

ANSI A 137.1 compliant

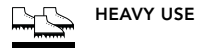
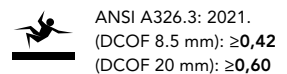
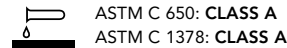
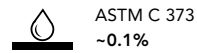
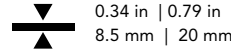
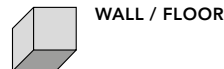

Chamonix HCX10 Bianco - Indoor  
HCX210 Bianco - Outdoor



Chamonix HCX01 Beige - Indoor  
HCX201 Beige - Outdoor



Chamonix HCX05 Gray - Indoor  
HCX205 Gray - Outdoor



Chamonix HCX08 Dark Gray - Indoor  
HCX208 Dark Gray - Outdoor

Graphics number

| Sizes   | Chamonix HCX10 Bianco | Chamonix HCX01 Beige | Chamonix HCX05 Gray | Chamonix HCX08 Dark Gray |
|---------|-----------------------|----------------------|---------------------|--------------------------|
| 24"x48" | 10                    | 10                   | 10                  | 10                       |
| 24"x24" | 20                    | 20                   | 20                  | 20                       |
| 12"x24" | 40                    | 40                   | 40                  | 40                       |

Indoor Packaging

| Sizes                 | Pieces | Sq.Ft. |       | Lbs.  |        |         |
|-----------------------|--------|--------|-------|-------|--------|---------|
|                       |        | Sq.Ft. | Lbs.  | Boxes | Sq.Ft. | Lbs.    |
| 24"x48"               | 2      | 15.50  | 61.00 | 36    | 558.00 | 2236.00 |
| 24"x24"               | 6      | 23.25  | 91.50 | 24    | 558.00 | 2236.00 |
| 12"x24"               | 8      | 15.50  | 61.40 | 32    | 496.00 | 1932.48 |
| 12"x12" mosaic        | 10     | 9.70   | -     | -     | -      | -       |
| 10"x12" hexagon       | 10     | 8.40   | -     | -     | -      | -       |
| 12"x24" muretto brick | 4      | 7.75   | -     | -     | -      | -       |
| 4"x24" bullnose       | 10     | -      | -     | -     | -      | -       |

Outdoor Packaging

| Sizes                           | Pieces | Sq.Ft. |       | Lbs.  |        |         |
|---------------------------------|--------|--------|-------|-------|--------|---------|
|                                 |        | Sq.Ft. | Lbs.  | Boxes | Sq.Ft. | Lbs.    |
| 24"x24"                         | 2      | 7.75   | 71.17 | 32    | 248.00 | 2277.30 |
| 12"x24" pool coping             | 2      | 3.87   | 35.58 | -     | -      | -       |
| 12"x24" pool coping (3cm thick) | 1      | 1.94   | 17.80 | -     | -      | -       |

# Chamonix

24"x48" 24"x24" 12"x24"

Stone Effect



Stone Effect

# Chamonix

RECTIFIED COLLECTION

## Indoor



**GCCX10R**  
Chamonix HCX10 Bianco Rect.  
24"x48" . 60x120 cm



**G3CX10MO**  
Chamonix HCX10 Bianco Mosaic\*  
(sheet 12"x12" . 30x30 cm)



**G8CX10MU**  
Chamonix HCX10 Bianco Muretto Brick\*  
12"x24" . 30x60 cm



**G0CX10**  
Chamonix HCX10 Bianco Bullnose  
4"x24" . 10x60 cm



**G8CX10R**  
Chamonix HCX10 Bianco Rect.  
12"x24" . 30x60 cm



**G9CX10R**  
Chamonix HCX10 Bianco Rect.  
24"x24" . 60x60 cm



**G3CX10HEX1**  
Chamonix HCX10 Bianco Hexagon\*  
(sheet 10"x12" 26x30 cm)

# Chamonix 2

PRESSED COLLECTION

## Outdoor



**S9CX10**  
Chamonix2 HCX210 Bianco  
24"x24" . 60x60 cm

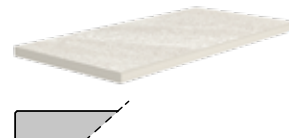

**S8CX10MC**  
Chamonix2 HCX210 Bianco  
Pool Coping with modern edge  
12"x24" . 30x60 cm



**T8CX10G30R**  
Chamonix2 HCX310 Bianco  
Pool Coping with modern edge  
12"x24" . 30x60 cm  
1.18" - 3 cm thick

# Chamonix

RECTIFIED COLLECTION

## Indoor



**GCCX01R**  
Chamonix HCX01 Beige Rect.  
24"x48" . 60x120 cm

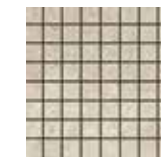

**G3CX01MO**  
Chamonix HCX01 Beige Mosaic\*  
(sheet 12"x12" . 30x30 cm)



**G8CX01MU**  
Chamonix HCX01 Beige Muretto Brick\*  
12"x24" . 30x60 cm



**G0CX01**  
Chamonix HCX01 Beige Bullnose  
4"x24" . 10x60 cm



**G8CX01R**  
Chamonix HCX01 Beige Rect.  
12"x24" . 30x60 cm



**G9CX01R**  
Chamonix HCX01 Beige Rect.  
24"x24" . 60x60 cm



**G3CX01HEX1**  
Chamonix HCX01 Beige Hexagon\*  
(sheet 10"x12" 26x30 cm)

# Chamonix 2

PRESSED COLLECTION

## Outdoor



**S9CX01**  
Chamonix2 HCX201 Beige  
24"x24" . 60x60 cm

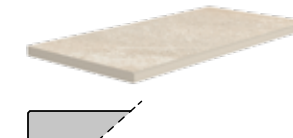

**S8CX01MC**  
Chamonix2 HCX201 Beige  
Pool Coping with modern edge  
12"x24" . 30x60 cm

# Chamonix

RECTIFIED COLLECTION

## Indoor



**GCCX05R**  
Chamonix HCX05 Gray Rect.  
24"x48" . 60x120 cm



**G8CX05R**  
Chamonix HCX05 Gray Rect.  
12"x24" . 30x60 cm



**G9CX05R**  
Chamonix HCX05 Gray Rect.  
24"x24" . 60x60 cm



**G3CX05MO**  
Chamonix HCX05 Gray Mosaic\*  
(sheet 12"x12" . 30x30 cm)



**G3CX05HEX1**  
Chamonix HCX05 Gray Hexagon\*  
(sheet 10"x12" 26x30 cm)



**G8CX05MU**  
Chamonix HCX05 Gray Muretto Brick\*  
12"x24" . 30x60 cm



**G0CX05**  
Chamonix HCX05 Gray Bullnose  
4"x24" . 10x60 cm

# Chamonix 2

PRESSED COLLECTION

## Outdoor



**S9CX05**  
Chamonix2 HCX205 Gray  
24"x24" . 60x60 cm



**S8CX05MC**  
Chamonix2 HCX205 Gray  
Pool Coping with modern edge  
12"x24" . 30x60 cm



**T8CX05G30R**  
Chamonix2 HCX305 Gray  
Pool Coping with modern edge  
12"x24" . 30x60 cm  
1.18" - 3 cm thick

# Chamonix

RECTIFIED COLLECTION

## Indoor



**GCCX08R**  
Chamonix HCX08 Dark Gray Rect.  
24"x48" . 60x120 cm



**G8CX08R**  
Chamonix HCX08 Dark Gray Rect.  
12"x24" . 30x60 cm



**G9CX08R**  
Chamonix HCX08 Dark Gray Rect.  
24"x24" . 60x60 cm



**G3CX08MO**  
Chamonix HCX08 Dark Gray Mosaic\*  
(sheet 12"x12" . 30x30 cm)



**G3CX08HEX1**  
Chamonix HCX08 Dark Gray Hexagon\*  
(sheet 10"x12" 26x30 cm)



**G8CX08MU**  
Chamonix HCX08 Dark Gray Muretto Brick\*  
12"x24" . 30x60 cm



**G0CX08**  
Chamonix HCX08 Dark Gray Bullnose  
4"x24" . 10x60 cm

# Chamonix 2

PRESSED COLLECTION

## Outdoor



**S9CX08**  
Chamonix2 HCX208 Dark Gray  
24"x24" . 60x60 cm



**S8CX08MC**  
Chamonix2 HCX208 Dark Gray  
Pool Coping with modern edge  
12"x24" . 30x60 cm





# West 57th

24"x24" 12"x24"

**Indoor** 8.5 mm



12"x24" - 30x60 cm

**Outdoor** 20 mm

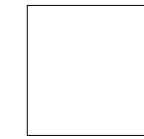

24"x24" - 60x60 cm



**West 57th**  
HWS10 Bianco - Indoor  
HWS210 Bianco - Outdoor



**West 57th**  
HWS05 Gray - Indoor  
HWS205 Gray - Outdoor

**Colored Body Porcelain Pavers and Stoneware**

**ANSI A 137.1 compliant**



WALL / FLOOR



MODERATE



0.34 in | 0.79 in  
8.5 mm | 20 mm



ASTM C 1026  
**RESISTANT**



ASTM C 373  
~0.1%



ASTM C 650: **CLASS A**  
ASTM C 1378: **CLASS A**



ANSI A326.3: 2021.  
(DCOF 8.5 mm):  $\geq 0,42$   
(DCOF 20 mm):  $\geq 0,60$



**HEAVY USE**

## Graphics number

| Sizes   | West 57th<br>HWS10 Bianco | West 57th<br>HWS05 Gray |
|---------|---------------------------|-------------------------|
| 24"x24" | 14                        |                         |
| 12"x24" | 38                        | 48                      |

## Indoor Packaging



| Sizes           | Pieces | Sq.Ft. | Lbs.  | Boxes | Sq.Ft. | Lbs.    |
|-----------------|--------|--------|-------|-------|--------|---------|
| 12"x24"         | 8      | 15.54  | 61.40 | 32    | 497.28 | 1965.00 |
| 12"x12" mosaic  | 10     | 9.70   | 36.00 | -     | -      | -       |
| 12"x24" muretto | 4      | 7.75   | 29.73 | -     | -      | -       |
| 3"x24" bullnose | 10     | -      | -     | -     | -      | -       |

## Outdoor Packaging



| Sizes               | Pieces | Sq.Ft. | Lbs.  | Boxes | Sq.Ft. | Lbs.    |
|---------------------|--------|--------|-------|-------|--------|---------|
| 24"x24"             | 2      | 7.75   | 71.17 | 32    | 248.00 | 2277.30 |
| 12"x24" pool coping | 2      | 3.87   | 35.58 | -     | -      | -       |

**West 57th**



See all indoor colors on our website

# West 57th

24"x24" 12"x24"

Stone Effect



Stone Effect

# West 57th

PRESSED COLLECTION

## Indoor



**G8WS10**  
West 57th HWS10 Bianco  
12"x24" . 30x60 cm



**G8WS10MU**  
West 57th HWS10 Bianco Muretto\*  
12"x24" . 30x60 cm



**G3WS10MO**  
West 57th HWS10 Bianco Mosaic\*  
(sheet 12"x12" . 30x30 cm)



**G0WS10**  
West 57th HWS10 Bianco Bullnose  
3"x24" . 7,5x60 cm

# West 57th 2

PRESSED COLLECTION

## Outdoor



**S9WS60U**  
West 57th2 HWS210 Bianco  
24"x24" . 60x60 cm

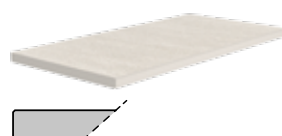

**S8WS10MC**  
West 57th2 HWS210 Bianco  
Pool Coping with modern edge  
12"x24" . 30x60 cm

# West 57th

PRESSED COLLECTION

## Indoor



**G8WS05**  
West 57th HWS05 Gray  
12"x24" . 30x60 cm



**G8WS05MU**  
West 57th HWS05 Gray Muretto\*  
12"x24" . 30x60 cm



**G3WS05MO**  
West 57th HWS05 Gray Mosaic\*  
(sheet 12"x12" . 30x30 cm)



**G0WS05**  
HWS05 Gray Bullnose  
3"x24" . 7,5x60 cm

# West 57th 2

PRESSED COLLECTION

## Outdoor



**S9WS55U**  
West 57th2 HWS205 Gray  
24"x24" . 60x60 cm

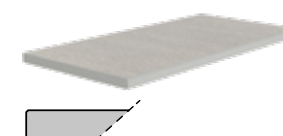

**S8WS05MC**  
West 57th2 HWS205 Gray  
Pool Coping with modern edge  
12"x24" . 30x60 cm



# Gotham

24"x24" 12"x24"

**Indoor** 8.5 mm



12"x24" - 30x60 cm

**Outdoor** 20 mm

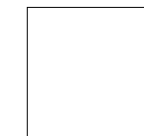

24"x24" - 60x60 cm

Glazed Porcelain Stoneware  
and Colored Body Porcelain Pavers

ANSI A 137.1 compliant



WALL / FLOOR



RANDOM



0.34 in | 0.79 in  
8.5 mm | 20 mm



ASTM C 1026  
**RESISTANT**



ASTM C 373  
~0.1%



ASTM C 650: **CLASS A**  
ASTM C 1378: **CLASS A**



ANSI A326.3: 2021.  
(DCOF 8.5 mm): ≥0,42  
(DCOF 20 mm): ≥0,60



**MEDIUM USE**  
8.5 mm



**HEAVY USE**  
20 mm

Gotham



See all indoor colors on our website



**Gotham**  
GO10 Bianco - Indoor  
HGO210 Bianco - Outdoor



**Gotham**  
GO05 Gray - Indoor  
HGO205 Gray - Outdoor



**Gotham**  
GO08 Nero - Indoor  
HGO208 Nero - Outdoor

## Graphics number

| Sizes   | Gotham<br>GO10 Bianco | Gotham<br>GO05 Gray | Gotham<br>GO08 Nero |
|---------|-----------------------|---------------------|---------------------|
| 24"x24" | 39                    | 14                  | 24                  |
| 12"x24" | 39                    | 42                  | 48                  |

## Indoor Packaging

| Sizes             | Pieces | Sq.Ft. | Lbs.  | Boxes | Sq.Ft. | Lbs.    |
|-------------------|--------|--------|-------|-------|--------|---------|
| 12"x24"           | 8      | 15.54  | 61.40 | 32    | 497.28 | 1965.00 |
| 12"x12" mosaic    | 10     | 9.70   | 35.82 | -     | -      | -       |
| 12"x12" intreccio | 10     | 9.70   | 35.82 | -     | -      | -       |
| 3"x12" bullnose   | 20     | -      | -     | -     | -      | -       |

## Outdoor Packaging

| Sizes               | Pieces | Sq.Ft. | Lbs.  | Boxes | Sq.Ft. | Lbs.    |
|---------------------|--------|--------|-------|-------|--------|---------|
| 24"x24"             | 2      | 7.75   | 71.17 | 32    | 248.00 | 2277.30 |
| 12"x24" pool coping | 2      | 3.87   | 35.58 | -     | -      | -       |

## Outdoor Modular Pattern Packaging

| Formats | Module |        | Sold in increments of |        |
|---------|--------|--------|-----------------------|--------|
|         | pieces | Sq.Ft. | pieces                | Sq.Ft. |
| 12"x12" | 1      | 0.97   | 6                     | 5.82   |
| 12"x24" | 1      | 1.94   | 6                     | 11.64  |
| 24"x24" | 1      | 3.87   | 6                     | 23.22  |
| Total   | 3      | 6.78   | 18                    | 40.70  |

# Gotham

24"x24" 12"x24"

Stone Effect



Stone Effect

# Gotham

PRESSED COLLECTION

## Indoor



**63GO10**  
Gotham GO10 Bianco  
12"x24" . 30x60 cm



**32GO10MO**  
Gotham GO10 Bianco Mosaic\*  
(sheet 12"x12" . 30x30 cm)



**32GO10IN**  
Gotham GO10 Bianco Intreccio\*  
(sheet 12"x12" . 30x30 cm)



**13GO10**  
Gotham GO10 Bianco Bullnose  
3"x12" . 8x30 cm

# Gotham 2

PRESSED COLLECTION

## Outdoor



**59GO60U**  
Gotham2 HGO210 Bianco  
24"x24" . 60x60 cm

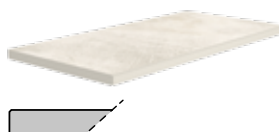

**58GO10MC**  
Gotham2 HGO210 Bianco  
Pool Coping with modern edge  
12"x24" . 30x60 cm

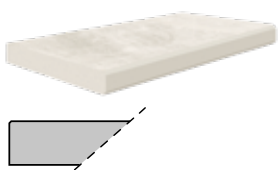

**T8GO10G30R**  
Gotham2 HGO310 Bianco  
Pool Coping with modern edge  
12"x24" . 30x60 cm  
1.18" - 3 cm thick\*

# Gotham

PRESSED COLLECTION

## Indoor



**63GO08**  
Gotham GO08 Nero  
12"x24" . 30x60 cm

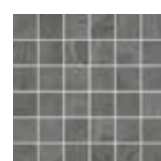

**32GO08MO**  
Gotham GO08 Nero Mosaic\*  
(sheet 12"x12" . 30x30 cm)



**32GO08IN**  
Gotham GO08 Nero Intreccio\*  
(sheet 12"x12" . 30x30 cm)



**13GO08**  
Gotham GO08 Nero Bullnose  
3"x12" . 8x30 cm

# Gotham 2

PRESSED COLLECTION

## Outdoor



**59GO58U**  
Gotham2 HGO208 Nero  
24"x24" . 60x60 cm



**58GO08MC**  
Gotham2 HGO208 Nero  
Pool Coping with modern edge  
12"x24" . 30x60 cm

# Gotham

PRESSED COLLECTION

## Indoor



**63GO05**  
Gotham GO05 Gray  
12"x24" . 30x60 cm



**32GO05MO**  
Gotham GO05 Gray Mosaic\*  
(sheet 12"x12" . 30x30 cm)



**32GO05IN**  
Gotham GO05 Gray Intreccio\*  
(sheet 12"x12" . 30x30 cm)



**13GO05**  
Gotham GO05 Gray Bullnose  
3"x12" . 8x30 cm

# Gotham 2

PRESSED COLLECTION

## Outdoor



**59GO55U**  
Gotham2 HGO205 Gray  
24"x24" . 60x60 cm

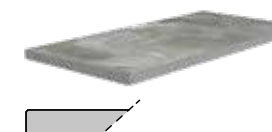

**58GO05MC**  
Gotham2 HGO205 Gray  
Pool Coping with modern edge  
12"x24" . 30x60 cm

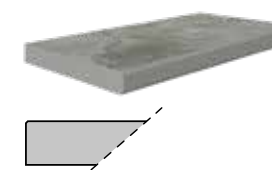

**T8GO05G30R**  
Gotham2 HGO305 Gray  
Pool Coping with modern edge  
12"x24" . 30x60 cm  
1.18" - 3 cm thick

# Modular Pattern

## Gotham 2 Layout

RECTIFIED COLLECTION



**MSGO55MOD**  
Gotham2 HGO205 Gray Rect.  
24"x24" . 60x60 cm

Gotham2 HGO205 Gray Rect.  
12"x24" . 30x60 cm

Gotham2 HGO205 Gray Rect.  
12"x12" . 30x30 cm

These items are supplied rectified and ready for installation in a modular pattern. According to the quantities required, as per the table. Product will be invoiced as 3 separate items.

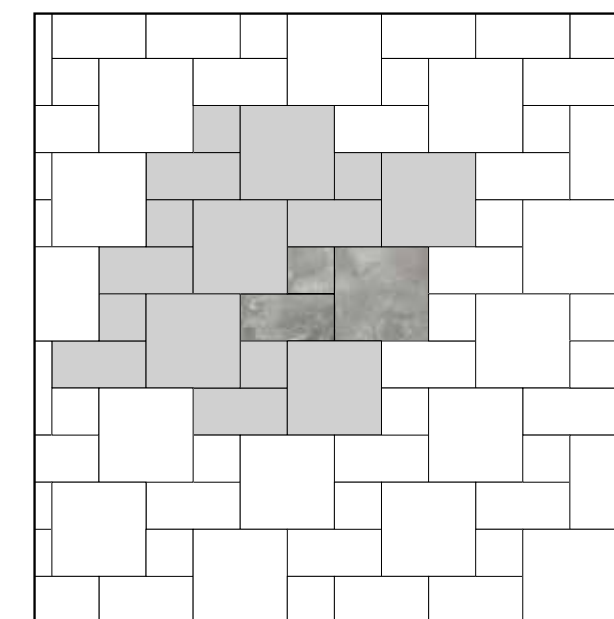



# Nature

24"x48" 24"x24" 12"x24" 4"x12"

**Indoor** 8.5 mm

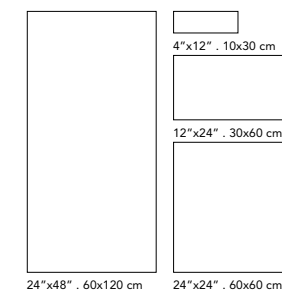

**Outdoor** 20 mm

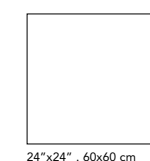

**Colored Body Porcelain Pavers and Stoneware**

**ANSI A 137.1 compliant**

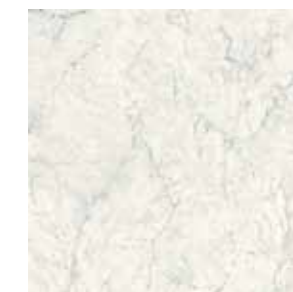
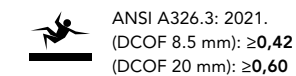
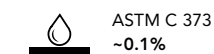
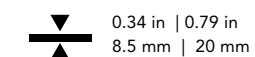
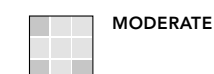

**Nature**  
NA20 Carrara - Indoor  
HNA220 Carrara - Outdoor



**Nature**  
NA05 Dolomite - Indoor  
HNA205 Dolomite - Outdoor

**Graphics number**

| Sizes   | Nature NA20 Carrara | Nature NA05 Dolomite |
|---------|---------------------|----------------------|
| 24"x48" | 8                   | 8                    |
| 24"x24" | 16                  | 16                   |
| 12"x24" | 32                  | 32                   |

**Indoor Packaging**

| Sizes           | Pieces | Sq.Ft. | Lbs.  | Boxes | Sq.Ft. | Lbs.    |
|-----------------|--------|--------|-------|-------|--------|---------|
| 24"x48"         | 2      | 15.50  | 61.00 | 36    | 558.00 | 2236.00 |
| 24"x24"         | 6      | 23.25  | 91.50 | 24    | 558.00 | 2236.00 |
| 12"x24"         | 8      | 15.50  | 61.40 | 32    | 496.00 | 1932.48 |
| 4"x12"          | 36     | 11.65  | 46,45 | 40    | 466.00 | 1858.00 |
| 12"x12" mosaic  | 10     | 9.70   | -     | -     | -      | -       |
| 10"x12" hexagon | 10     | 8.40   | -     | -     | -      | -       |
| 4"x24" bullnose | 10     | -      | -     | -     | -      | -       |

**Outdoor Packaging**

| Sizes               | Pieces | Sq.Ft. | Lbs.  | Boxes | Sq.Ft. | Lbs.    |
|---------------------|--------|--------|-------|-------|--------|---------|
| 24"x24"             | 2      | 7.75   | 71.17 | 32    | 248.00 | 2277.30 |
| 12"x24" pool coping | 2      | 3.87   | 35.58 | -     | -      | -       |

**Nature**



See all indoor colors on our website

# Nature

24"x48" 24"x24" 12"x24" 4"x12"

NA

Marble Effect



Marble Effect



# Nature

RECTIFIED COLLECTION

## Indoor



**80NA20R**  
Nature NA20 Carrara Rect.  
24"x48" . 60x120 cm

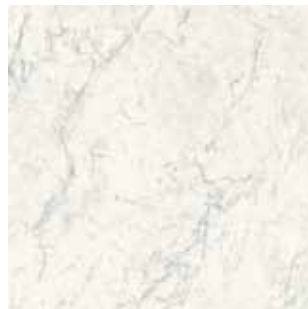

**60NA20R**  
Nature NA20 Carrara Rect.  
24"x24" . 60x60 cm



**32NA20MO**  
Nature NA20 Carrara Mosaic\*  
(sheet 12"x12" . 30x30 cm)



**13NA20**  
Nature NA20 Carrara Bullnose  
4"x24" . 10x60 cm



**63NA20R**  
Nature NA20 Carrara Rect.  
12"x24" . 30x60 cm



**30NA20**  
Nature NA20 Carrara Rect.  
4"x12" . 10x30 cm



**32NA20HEX1**  
Nature NA20 Carrara Hexagon\*  
(sheet 10"x12" . 26x30 cm)

# Nature 2

PRESSED COLLECTION

## Outdoor

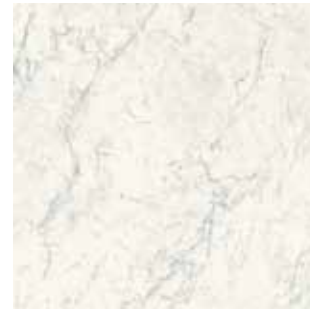

**S9NA20**  
Nature2 HNA220 Carrara  
24"x24" . 60x60 cm



**S8NA20MC**  
Nature2 HNA220 Carrara  
Pool Coping with modern edge  
12"x24" . 30x60 cm

# Nature

RECTIFIED COLLECTION

## Indoor



**80NA05R**  
Nature NA05 Dolomite Rect.  
24"x48" . 60x120 cm



**60NA05R**  
Nature NA05 Dolomite Rect.  
24"x24" . 60x60 cm



**32NA05MO**  
Nature NA05 Dolomite Mosaic\*  
(sheet 12"x12" . 30x30 cm)



**13NA05**  
Nature NA05 Dolomite Bullnose  
4"x24" . 10x60 cm



**80NA05S** **MADE IN ITALY**  
Nature NA05 Dolomite **Polished** Rect.  
24"x48" . 60x120 cm



**63NA05R**  
Nature NA05 Dolomite Rect.  
12"x24" . 30x60 cm



**30NA05**  
Nature NA05 Dolomite Rect.  
4"x12" . 10x30 cm



**32NA05HEX1**  
Nature NA05 Dolomite Hexagon\*  
(sheet 10"x12" . 26x30 cm)

# Nature 2

PRESSED COLLECTION

## Outdoor



**S9NA05**  
Nature2 HNA205 Dolomite  
24"x24" . 60x60 cm



**S8NA05MC**  
Nature2 HNA205 Dolomite  
Pool Coping with modern edge  
12"x24" . 30x60 cm



Wall: Nature NA07 Calacatta Gold Rect. 12"x24" - Woodscape WS03 Natural Rect. 8"x48"  
 Floor: Essential HET05 Gray Rect. 24"x48"  
 Counter: Essential HET05 Gray Card Mosaic 12"x12" (sheet)

# Essential

24"x48" 24"x24" 12"x24" 4"x12"

Indoor 8.5 mm

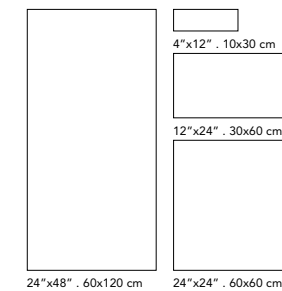

Outdoor 20 mm



Colored Body Porcelain Pavers and Stoneware

ANSI A 137.1 compliant

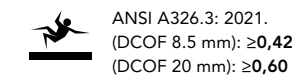
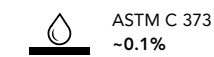
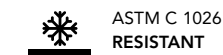
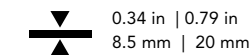
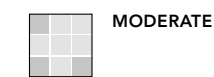

Essential  
 HET01 Beige - Indoor  
 HET201 Beige - Outdoor



Essential  
 HET10 White - Indoor  
 HET210 White - Outdoor



Essential  
 HET05 Gray - Indoor  
 HET205 Gray - Outdoor



Essential  
 HET08 Graphite - Indoor  
 HET208 Graphite - Outdoor

## Graphics number

| Sizes   | Essential HET01 Beige | Essential HET10 White | Essential HET05 Gray | Essential HET08 Graphite |
|---------|-----------------------|-----------------------|----------------------|--------------------------|
| 24"x48" | 10                    | 10                    | 10                   | 10                       |
| 24"x24" | 20                    | 20                    | 20                   | 20                       |
| 12"x24" | 40                    | 40                    | 40                   | 40                       |

## Indoor Packaging

| Sizes                    | Pieces | Sq.Ft. | Lbs.  | Boxes | Sq.Ft. | Lbs.    |
|--------------------------|--------|--------|-------|-------|--------|---------|
| 24"x48"                  | 2      | 15.50  | 61.00 | 36    | 558.00 | 2236.00 |
| 24"x24"                  | 6      | 23.25  | 91.50 | 24    | 558.00 | 2236.00 |
| 12"x24"                  | 8      | 15.50  | 61.40 | 32    | 496.00 | 1932.48 |
| 4"x12"                   | 36     | 11.65  | 46,45 | 40    | 466.00 | 1858.00 |
| 12"x24" essential design | 8      | 15.50  | 61.40 | 32    | 496.00 | 1932.48 |
| 12"x12" mosaic           | 10     | 9.70   | -     | -     | -      | -       |
| 12"x12" card mosaic      | 10     | 9.70   | -     | -     | -      | -       |
| 4"x24" bullnose          | 10     | -      | -     | -     | -      | -       |

## Outdoor Packaging

| Sizes               | Pieces | Sq.Ft. | Lbs.  | Boxes | Sq.Ft. | Lbs.    |
|---------------------|--------|--------|-------|-------|--------|---------|
| 24"x24"             | 2      | 7.75   | 71.17 | 32    | 248.00 | 2277.30 |
| 12"x24" pool coping | 2      | 3.87   | 35.58 | -     | -      | -       |

# Essential

24"x48" 24"x24" 12"x24" 4"x12"

HET



Concrete Effect

Concrete Effect

# Essential

RECTIFIED COLLECTION

## Indoor



**GCET01R**  
Essential HET01 Beige Rect.  
24"x48" . 60x120 cm



**30ET01**  
Essential HET01 Beige Rect.  
4"x12" . 10x30 cm



**G9ET01R**  
Essential HET01 Beige Rect.  
24"x24" . 60x60 cm

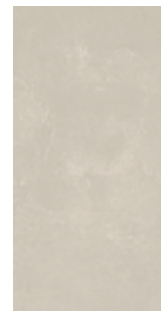

**G8ET01R**  
Essential HET01 Beige Rect.  
12"x24" . 30x60 cm



**G3ET01MO**  
Essential HET01 Beige Mosaic\*  
13/8"x13/8" . 3,5x3,5 cm  
(sheet 12"x12" . 30x30 cm)



**G3ET01MOC**  
Essential HET01 Beige Card Mosaic\*  
13/16"x4" . 3x10 cm  
(sheet 12"x12" . 30x30 cm)



**G0ET01**  
Essential HET01 Beige Bullnose  
4"x24" . 10x60 cm

# Essential 2

PRESSED COLLECTION

## Outdoor



**S9ET01**  
Essential2 HET201 Beige  
24"x24" . 60x60 cm



**S8ET01MC**  
Essential2 HET201 Beige  
Pool Coping with modern edge  
12"x24" . 30x60 cm

# Essential

RECTIFIED COLLECTION

## Indoor



**GCET10R**  
Essential HET10 White Rect.  
24"x48" . 60x120 cm



**G8ETDESIGNR**  
Essential Design Rect.  
12"x24" . 30x60 cm

The Design decoration can be used in both wall and floor tiles, and also in combination with the Woodland series.



**30ET10**  
Essential HET10 White Rect.  
4"x12" . 10x30 cm



**G9ET10R**  
Essential HET10 White Rect.  
24"x24" . 60x60 cm



**G8ET10R**  
Essential HET10 White Rect.  
12"x24" . 30x60 cm

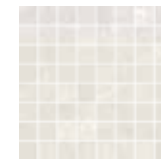

**G3ET10MO**  
Essential HET10 White Mosaic\*  
13/8"x13/8" . 3,5x3,5 cm  
(sheet 12"x12" . 30x30 cm)



**G3ET10MOC**  
Essential HET10 White Card Mosaic\*  
13/16"x4" . 3x10 cm  
(sheet 12"x12" . 30x30 cm)



**G0ET10**  
Essential HET10 White Bullnose  
4"x24" . 10x60 cm

# Essential 2

PRESSED COLLECTION

## Outdoor



**S9ET10**  
Essential2 HET210 White  
24"x24" . 60x60 cm



**S8ET10MC**  
Essential2 HET210 White  
Pool Coping with modern edge  
12"x24" . 30x60 cm

# Essential

RECTIFIED COLLECTION

## Indoor



**GCET05R**  
Essential HET05 Gray Rect.  
24"x48" . 60x120 cm



**G9ET05R**  
Essential HET05 Gray Rect.  
24"x24" . 60x60 cm



**G3ET05MO**  
Essential HET05 Gray Mosaic\*  
(sheet 12"x12" . 30x30 cm)



**G0ET05**  
Essential HET05 Gray Bullnose  
4"x24" . 10x60 cm



**G8ETDESIGNR**  
Essential Design Rect.  
12"x24" . 30x60 cm

The Design decoration can be used in both wall and floor tiles, and also in combination with the Woodland series.

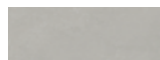

**30ET05**  
Essential HET05 Gray Rect.  
4"x12" . 10x30 cm

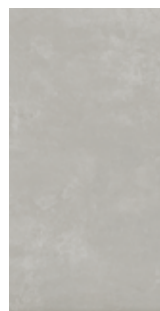

**G8ET05R**  
Essential HET05 Gray Rect.  
12"x24" . 30x60 cm



**G3ET05MOC**  
Essential HET05 Gray Card Mosaic\*  
(sheet 12"x12" . 30x30 cm)

# Essential 2

PRESSED COLLECTION

## Outdoor



**S9ET05**  
Essential2 HET205 Gray  
24"x24" . 60x60 cm

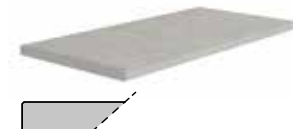

**S8ET05MC**  
Essential2 HET205 Gray  
Pool Coping with modern edge  
12"x24" . 30x60 cm

# Essential

RECTIFIED COLLECTION

## Indoor



**GCET08R**  
Essential HET08 Graphite Rect.  
24"x48" . 60x120 cm



**G3ET08MO**  
Essential HET08 Graphite Mosaic  
(sheet 12"x12" . 30x30 cm)

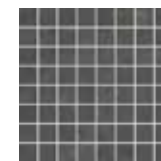

**G3ET08MO**  
Essential HET08 Graphite Mosaic\*  
(sheet 12"x12" . 30x30 cm)



**G0ET08**  
Essential HET08 Graphite Bullnose  
4"x24" . 10x60 cm



**G8ETDESIGNR**  
Essential Design Rect.  
12"x24" . 30x60 cm

The Design decoration can be used in both wall and floor tiles, and also in combination with the Woodland series.



**30ET08**  
Essential HET08 Graphite Rect.  
4"x12" . 10x30 cm



**G8ET08R**  
Essential HET08 Graphite Rect.  
12"x24" . 30x60 cm

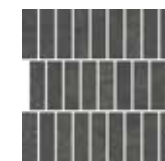

**G3ET08MOC**  
Essential HET08 Graphite Card Mosaic\*  
(sheet 12"x12" . 30x30 cm)

# Essential 2

PRESSED COLLECTION

## Outdoor

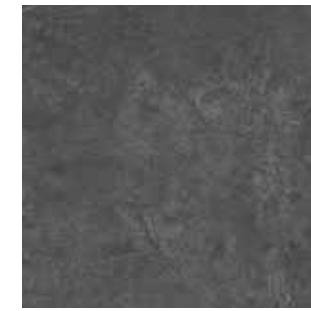

**S9ET08**  
Essential2 HET208 Graphite  
24"x24" . 60x60 cm



**S8ET08MC**  
Essential2 HET208 Graphite  
Pool Coping with modern edge  
12"x24" . 30x60 cm

# Pool Coping

Pool Coping with modern edge  
20 mm thick

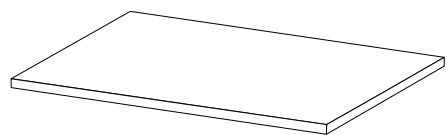

| Sizes   |               | Page |
|---------|---------------|------|
| 16"x32" | New England 2 | 4    |
|         | Quartzite 2   | 14   |
| 12"x24" | New England 2 | 4    |
|         | Chamonix 2    | 22   |
|         | West 57th 2   | 30   |
|         | Gotham 2      | 36   |
|         | Nature 2      | 42   |
|         | Essential 2   | 48   |

Pool Coping with modern edge  
30 mm thick

MADE IN ITALY

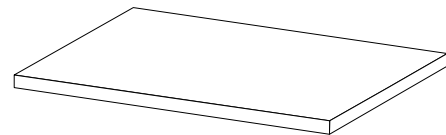

| Sizes   |                            | Page |
|---------|----------------------------|------|
| 12"x24" | Chamonix 2 (Bianco - Gray) | 22   |
|         | Gotham 2 (Bianco - Gray)   | 36   |

# Cleaning and Maintenance

Thanks to its great hardness and weather-resistance, due2 can be cleaned with almost any detergent. However, we recommend simply using a mild detergent and a water jet. For greater convenience and to avoid formation of limescale deposits, we recommend facilitating drainage with a rubber brush.



# Technical characteristics

# Key to symbols

## TECHNICAL CHARACTERISTICS AND STANDARDS OF REFERENCE

Our first choice porcelain tiles are compliant with ISO 13006 & ANSI A137.1 standard.

Therefore they must not be perfect (which is impossible for any industrial product) but fall within the tolerances defined by the standard.

The valuation of the appearance of the tiles shall be performed, as defined by the standard, placing tiles on a viewing board and examining it (perpendicularly) from a distance of at least 1 meter (3.3 feet).

Defects of tiles can be of two types: noticeable (already visible before setting, such as color differences, surface defects, fractures, etc) or hidden (not visible before setting). Claims about noticeable defects may be made only before tiles are installed, allowing the manufacturer to replace any defective material. However, if the buyer or tile installer decides to proceed with installation, the responsibility of the manufacturer is invalidated. No claims will be accepted regarding installed product.

Responsibility for hidden defects remains with the producer if these are notified within the legal time limits.

Catalogs indicate nominal size, not actual size.





## RECOMMENDATIONS FOR USE

No laboratory test, however efficient it may be, is sufficient to determine the durability of a product. Apart from the obvious factor of the number of foot contacts, durability can also be influenced by the technical characteristics of the product, location of the installation and the possible presence of abrasive agents. We therefore recommend not only that products should be chosen with resistance characteristics that are sufficient for the intended use, as shown in the following chart, but also that floors should be protected against sand, grit and other abrasives with the use, for example, of mats.

See [www.delconcausa.com/download/edpceramictile.pdf](http://www.delconcausa.com/download/edpceramictile.pdf) to download the EPD report covering Del Conca USA products.

## ANSI A 137.1

### Colored Body Porcelain Stoneware Glazed Porcelain Stoneware

|   | Established limits | Performances                         | Norms                        |
|---|--------------------|--------------------------------------|------------------------------|
|  Water absorption                  | ≤ 0,5%             | ~ 0,1%                               | ASTM C 373                   |
|  Breaking strength (1)             | ≥ 250 lbf.         | Conforms                             | ASTM C 648                   |
|  Resistance to freeze-thaw cycling | Resistant          | Frost proof                          | ASTM C 1026                  |
|  Resistance to thermal shock       | Resistant          | Resistant                            | ASTM C 484                   |
|  Slip resistance (DCOF)            | ≥ 0,42             | Only for Natural Surface<br>Conforms | ANSI A326.3: 2021.<br>(DCOF) |
|  Chemical resistance               | As reported        | Class: A                             | ASTM C 650                   |
|  Stain resistance                  | As reported        | Class: A                             | ASTM C 1378                  |

Reference values valid for almost all our collections. Browse through our website for further specifications.

(1) It states the resistance of a sample piece, leaning on three spots, to a concentrated load placed in the middle.

## SHADE VARIATIONS

 **LOW**  
Uniform colour with only minimal differences between tiles in the same production run.

 **MODERATE**  
Clearly distinguishable differences in texture and pattern within the same production run.

 **HIGH**  
Significant variation in texture, pattern and colour from tile to tile within the same production run. The colour range should be viewed before selecting the material.

 **RANDOM**  
Random differences from tile to tile. One tile may have totally different texture and colour from another. The colour range should be viewed before selecting the material.

## RECOMMENDED USE

 Recommended for floors for medium-light use, as in private homes, with the exception of kitchens and rooms with direct outdoor access.











 Recommended for all rooms in the house and for business premises with medium use.

 Recommended for all rooms indoors and outdoors and for business premises in general.

## ANSI A 137.1

### due 2

#### Colored Body Porcelain Pavers 20 mm thick

|   | Established limits | Performances   | Norms                        |
|---|--------------------|--|------------------------------|
|  Water absorption  | ≤ 0,5%             | ~ 0,1%   | ASTM C 373                   |
|  Breaking strength (1)                                   | ≥ 250 lbf.         | ~3000 lbf.   | ASTM C 648                   |
|  Frost resistance  | Resistant          | Resistant  | ASTM C 1026                  |
|  Resistance to thermal shock                             | Resistant          | Resistant  | ASTM C 484                   |
|  Average breaking load for raised floor installation (2) |                    | <b>Classe 1</b><br>16"x32" : > 4 kN<br>24"x24" : > 4 kN<br><b>Classe 2</b><br>16"x48" : > 6 kN | EN 12825*                    |
|  Mechanical strength (3)                                 |                    | 16"x48" : U3<br>16"x32" : U4<br>24"x24" : U7   | EN 1339-F*                   |
|  Slip resistance (DCOF)                                 | ≥ 0,42             | ≥ 0,60   | ANSI A326.3: 2021.<br>(DCOF) |
|  Chemical resistance                                   | As reported        | Class: A   | ASTM C 650                   |
|  Stain resistance                                      | As reported        | Class: A   | ASTM C 1378                  |
|  Recommended use                                       |                    |           |                              |

\* Tests carried out on a different type from that for which the standard is issued

(1) It states the resistance of a sample piece, leaning on three spots, to a concentrated load placed in the middle.

(2) It shows the resistance, on raised floor laying as suggested by the catalogue, to a concentrated load applied in the middle.

(3) It shows the breaking resistance through bending of the product in full size. The load is applied through a horizontal cylinder placed in the middle.

# Mosaics and Muretto sizes

## Mosaic

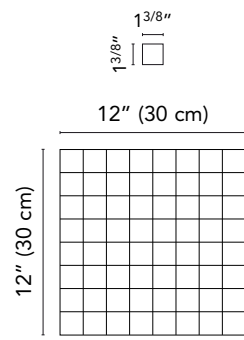

Available on series:

**New England  
Quartzite  
Chamonix  
Nature  
Essential**

## Mosaic

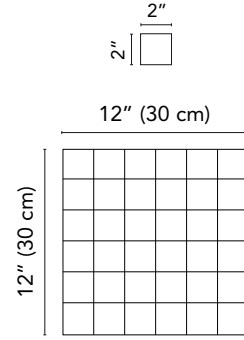

Available on series:

**Gotham**

## Mosaic

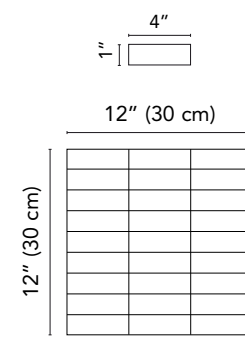

Available on series:

**West 57th**

## Card Mosaic

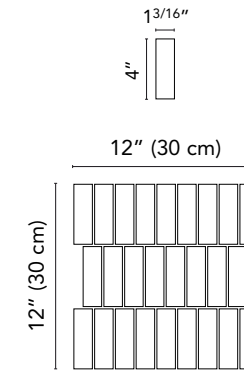

Available on series:

**Essential**

## Brick

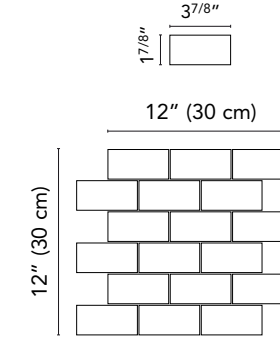

Available on series:

**New England**

## Muretto Wall

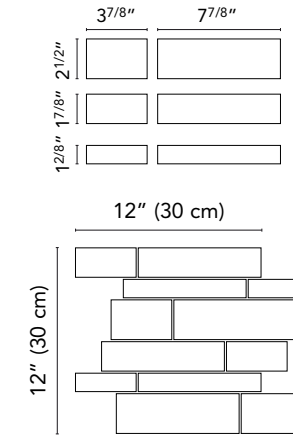

Available on series:

**Quartzite**

## Herringbone Mosaic

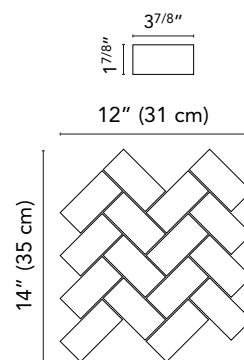

Available on series:

**New England**

## Hexagon

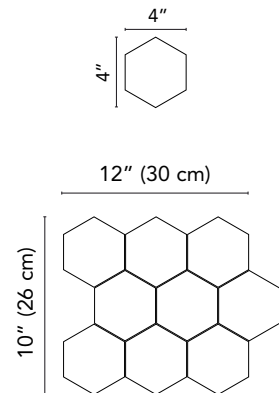

Available on series:

**Chamonix  
Nature**

## Intreccio

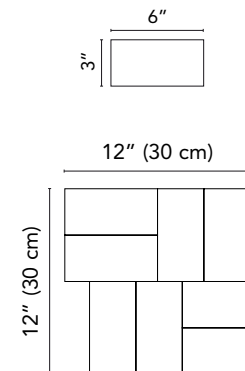

Available on series:

**Gotham**

## Muretto Brick

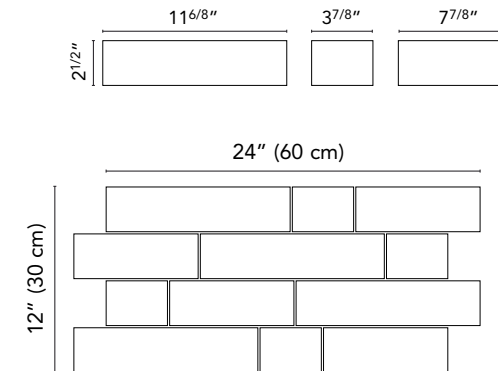

Available on series:

**Chamonix**

## Muretto

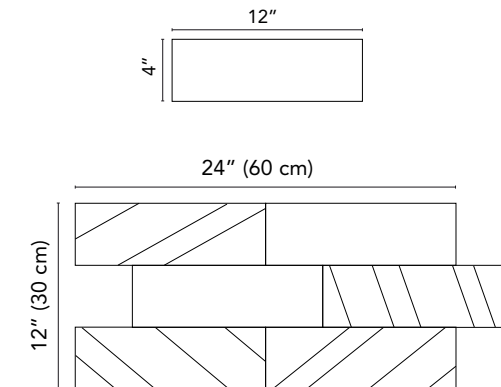

Available on series:

**West 57th**



# Terms and conditions of sale

1. These Terms and Conditions of Sale shall apply to all orders and contracts entered into by Del Conca USA, Inc. (the "Seller" or "Del Conca") and the Purchaser for the sale of products manufactured or distributed by Del Conca USA (the "Products") unless Seller otherwise specifically agrees in writing. By placing any order for Products, the Purchaser agrees to these Terms and Conditions of Sale. Any other terms or conditions which may at any time be indicated by the Purchaser, in the Purchaser's order form or otherwise (whether oral, typed, written or printed) shall be null and void and of no effect, even if not expressly objected to by the Seller.

2. All prices are stated in U.S. Dollars per square foot or per piece unless otherwise noted.

3. Prices are for first choice material only.

4. Full Truckload (FTL) prices are applied only to orders for shipment of at least 43,000 pounds (including pallet weight) from the Loudon, TN factory and comprised exclusively of materials stored at that specific facility.

5. All pricing is calculated FOB Factory (Loudon, TN), excluding transportation and shipping charges, taxes, fees and custom duties.

6. The Purchaser shall make all payments pursuant to the invoices issued by the Seller, notwithstanding any claim for any alleged defect, fault or irregularity in the Products. Unless otherwise specifically agreed by the Seller in writing, payment by the Purchaser is due upon receipt of Seller's invoice. Invoice for FTL shall be payable within 30 days from the issuance of the invoice. In the event of any delay in payment, the Seller shall have the right to suspend deliveries and may, at its option (i) require immediate payment of all or any part of any and all sums owed by the Purchaser, irrespective of any credit terms previously agreed to, and (ii) terminate the Contract (as well as any and all other contracts with the Purchaser) in whole or in part, and hold the Purchaser liable for damages. In addition, in the event the Seller does not receive full payment by the due date, the Purchaser shall pay to the Seller interest on the unpaid amount, from the due date to the date payment is actually received by the Seller, at the monthly rate of interest of one and one half percent (1 ½%), but not to exceed the highest amount allowed by law. Seller's right to such interest shall be in addition to, and not in lieu of, all other rights and remedies arising by reason of such nonpayment. Any payment received by the Seller may be applied to any outstanding balance owed by the Purchaser to the Seller, as the Seller, in its sole discretion, may determine, any instructions of the Purchaser to the contrary notwithstanding.

7. Del Conca USA reserves the right to apply a surcharge on orders comprising non-full pallets.

8. All orders are subject to availability. No order of the Purchaser will be binding upon Del Conca USA unless accepted by Del Conca USA on Del Conca USA's form of Order Confirmation, signed by an officer or employee of Del Conca USA duly authorized to sign on behalf of Del Conca USA, and then only as and to the extent set forth in such Order Confirmation. Del Conca USA reserves the right to reject any order in whole or in part. Any term, condition or provision set forth in Seller's Order Confirmation which is not objected to by the Purchaser in writing within ten days after the date thereof will conclusively be deemed to have been accepted by the Purchaser. Every order of the Purchaser will be binding on the Purchaser unless and until it is rejected in writing by the Seller, and may not be cancelled, withdrawn or modified by the Purchaser; however, in the event of a partial acceptance by the Seller, the Purchaser will no longer be bound with respect to the parts of the order not accepted by the Seller.

9. Purchaser will take delivery of the Products at the Seller's premises ("ex factory"). Unless otherwise specifically agreed by Seller in writing: (i) all risk of loss or damage to the Products shall pass to the Purchaser upon delivery of the Products by the Seller to a carrier; (ii) the Seller shall not be required to procure insurance to cover the Products during transportation in shipment; (iii) any shipping arrangements made by the Seller with carriers or forwarding agents at the Purchaser's request shall be made solely on the Purchaser's behalf and at the Purchaser's sole cost and risk; (iv) any agent appointed for such shipment shall be solely the Purchaser's agent for all purposes; (v) the Purchaser shall be responsible for all the unloading and receipt of the Products at its destination; and (vi) any claim for loss or damage shall be made by the Purchaser solely against the carrier.

10. Any delivery dates specified by the Seller will be deemed to be estimates only, unless specific commitments are made in writing by the Seller. In no event is the time of delivery of the Products of the essence. The Seller reserves the right to cancel, in whole or in part, or to suspend or delay, in whole or in part, any orders due to (i) shortages of, or failures of Seller's suppliers to deliver, or delays of Seller's suppliers in delivering materials, (ii) work stoppages or other labor troubles, (iii) acts of God or (iv) any event in the nature of force majeure or beyond Seller's control. Delivery dates will be extended by the amount of any additional time required by the Seller to make delivery as a result of any such condition or event. The Seller also reserves the right to discontinue particular Products or lines of Products, or to substitute other Products or lines, in response to production and market requirements and demands. The Purchaser waives any and all claims and rights which the Purchaser might otherwise have arising out of or in connection with or relating to any delay in delivery of the Products for any reason whatsoever or any failure of the Seller to deliver by reason of the exercise by the Seller of any of its rights pursuant to these Terms and Conditions of Sale, including, without limitation, any and all claims for or rights to direct, indirect, incidental, consequential or other damages or compensation, and any and all rights to terminate or cancel the order, in whole or in part.

11. Product representations made in photographs, catalogs, advertisement, sampling and online formats as well as in any other publications are indicative of the product only. Variations in color finish and size can occur and the Seller does not warrant the uniformity of color, tone or shade of the Products or the conformity of the Products to the color, tone or shade of any sample. It is Purchaser's responsibility to verify the suitability of the material before installation.

12. Any Product return shall be previously authorized by Del Conca USA and returned products must be accompanied by an approved Return Authorization form and is subject to a 25% handling charge. Freight for the return is the responsibility of the Purchaser.

13. Limited Warranty / Product Claims: Del Conca USA warrants that its first choice, domestically produced ceramic tile is manufactured according to ANSI A137.1 and meets or exceeds these requirements. If a first choice tile purchased by the Purchaser pursuant to these Terms and Conditions of Sale is proven to contain a manufacturing defect, Del Conca USA will supply, free of charge, material of compatible color and shade, as determined by Del Conca USA. **Labor charges are expressly excluded from this warranty.** The Purchaser waives any and all other claims and rights which the Purchaser might otherwise have arising out of or in connection with or relating to any breach of warranty or arising out of or in connection with or relating to any defect, fault or irregularity in the Products, including, without limitation, any and all claims for or rights to direct, indirect, incidental, consequential or other compensation or damages, and any and all rights to terminate or cancel the order, in whole or in part.

14. Del Conca USA makes no warranty as to the suitability of its tile for a particular installation. Del Conca USA does not warrant that its glazed or unglazed tile will not scratch, chip, or show signs of wear.

15. Del Conca USA must be notified by the Purchaser of any claims or defects as soon as reasonably possible, but in any case not later than six months after the Products have been delivered by Del Conca USA. Any claim of the Purchaser of any and every kind must be in writing and sent by certified mail, return receipt requested. Failure to make any claim in such manner or within such six month period shall constitute an irrevocable acceptance of the Products.

16. Claims concerning shade, appearance, caliber, finish or obvious defects in first choice production must be communicated before the tile is installed. No claims will be accepted for tile already installed or for defects in other than first choice material.

17. Del Conca USA specifically excludes liability for consequential or incidental damages except where exclusion of consequential damage is not permitted by state law.

18. This limited warranty shall constitute the full extent of Del Conca USA's liability and is in place of all other warranties or representations, express or implied, including, without limitation, any warranty of merchantability or fitness for a particular purpose.

19. Until the Seller collects in full all amounts required to be paid by the Purchaser for the Products, as well as any and all other amounts owed by the Purchaser to the Seller, the Seller retains title to the Products, and shall have a first and senior purchase money security interest in, an lien on, the Products and all proceeds thereof, under the Uniform Commercial Code as in effect in the United States, to secure the payment of all such amounts. By placing an order with the Seller, the Purchaser authorizes the Seller to file any and all financing statements with respect to such security interest which Seller may deem necessary or desirable. The Purchaser shall, at the request of the Seller, execute any and all financing statements and other documents which the Seller may request to perfect or evidence such title and such security interest.

20. In the event the Seller retains a collection agency to collect any amount owed by the Purchaser, or institutes proceedings to collect such amount or to enforce any right against the Purchaser, including enforcement of any security interest granted to the Seller, the Purchaser shall reimburse the Seller for all collection agency fees and costs, or all costs incurred in such legal proceedings, including reasonable attorneys' fees.

21. The Parties agree that the laws of the State of Tennessee (without giving effect to principles of conflicts of law), to the exclusion of the laws of any other state, shall be applicable to all orders or contracts entered into pursuant to this Terms and Conditions of Sale, their construction, interpretation, effect, performance or non-performance or the consequences thereof. For all disputes or controversies which may arise between the Parties out of or in connection with all orders or contracts entered into pursuant to this Terms and Conditions of Sale, their construction, interpretation, effect, performance or non-performance or the consequences thereof, the Parties hereby consent to the jurisdiction of the courts in the State of Tennessee, and agrees that such courts, to the exclusion of all other courts, shall have exclusive jurisdiction with respect to any and all such disputes and controversies.



## Tile Council of North America (TCNA)

---

TCNA is the trade association representing manufacturers of ceramic tile, tile installation materials, tile equipment, raw materials, and other tile-related products of North America.

For further information, please visit [www.delconcausa.com](http://www.delconcausa.com)

The company reserves the right to make any change to products and features shown in this catalogue.  
All colors are purely a guide.

Any kind of copy of this catalogue, even partial reproduction, is prohibited.

© 2023 Del Conca USA, Inc. All rights reserved.

DECEMBER / 2023



Del Conca USA, Inc. - 155 Del Conca Way  
Loudon, TN 37774 - USA  
Tel 865.657.3550 - Fax 865.657.3554  
[www.delconcausa.com](http://www.delconcausa.com) - [sales@delconcausa.com](mailto:sales@delconcausa.com)