



Index

6	History
8	Where we are
10	About Del Conca USA
12	Product Effect
14	Technology
16	Our Team
18	Social Responsibility
20	Sustainability
22	User's Guide
26	Wood Effect
62	Stone Effect
128	Marble Effect
162	Concrete Effect
172	Brick Effect
186	Decorative Effect
202	Technical Characteristics
203	Layouts
204	Mosaics and Muretto sizes
206	Terms and conditions of sale

Alphabetical Index

- 56 Barton Creek
- 180 Cantina
- 96 Chamonix
- 156 Clast
- 164 Essential
- 188 Fragrance
- 122 Gotham
- 40 Hardin Valley
- 196 Havana
- 174 Kensington
- 50 Lumber
- 130 Nature
- 88 Navona
- 116 Neopolis
- 64 New England
- 80 Quartzite
- 72 Verona
- 46 Voyage
- 106 West 57th
- 28 Woodland
- 34 Woodscape

Index by Effect



Wood Effect

- 28 Woodland
- 34 Woodscape
- 40 Hardin Valley
- 46 Voyage
- 50 Lumber
- 56 Barton Creek



Stone Effect

- 64 New England
- 72 Verona
- 80 Quartzite
- 88 Navona
- 96 Chamonix
- 106 West 57th
- 116 Neopolis
- 122 Gotham

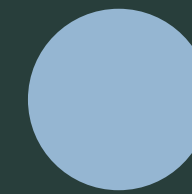

Marble Effect

- 130 Nature
- 156 Clast



Concrete Effect

- 164 Essential

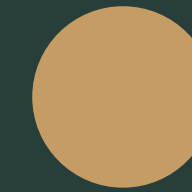

Brick Effect

- 174 Kensington
- 180 Cantina

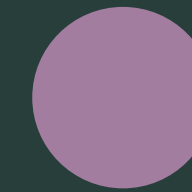

Decorative Effect

- 188 Fragrance
- 196 Havana

Index by Size

24x48 in

64 New England
130 Nature
80 Quartzite
88 Navona
164 Essential
96 Chamonix

12x48 in

80 Quartzite
88 Navona

8x48 in

28 Woodland
40 Hardin Valley
34 Woodscape

8x32 in

56 Barton Creek
46 Voyage

24x24 in

64 New England
130 Nature
164 Essential
96 Chamonix

12x24 in

64 New England
72 Verona
130 Nature
164 Essential
88 Navona
80 Quartzite
96 Chamonix
156 Clast
122 Gotham
116 Neopolis
106 West 57th

6x24 in

50 Lumber
46 Voyage

3x16 in

188 Fragrance
174 Kensington

4x12 in

130 Nature
164 Essential
88 Navona
80 Quartzite
180 Cantina
156 Clast
116 Neopolis

8x8 in

188 Fragrance
196 Havana

History

1962

CERAMICA FAETANO
FAETANO (SAN MARINO)



Faetano has produced hand made ceramics for decades, and today its designs carry this heritage embedded in their looks and colors.

1979

CERAMICA DEL CONCA
SAN CLEMENTE (ITALY)

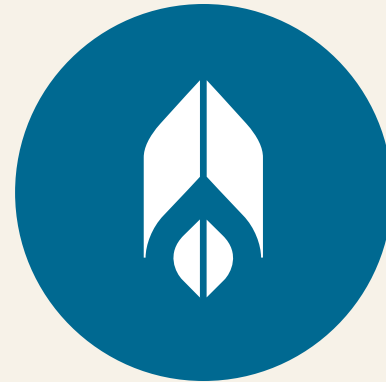

Ceramica Del Conca sets the foundation of the Del Conca Group. The company boasts a conspicuous sensibility for technological innovation, design, quality, research and the environment: testaments to a savvy ceramic culture.

2000/2017

CERAMICA DEL CONCA
SAN CLEMENTE (ITALY)
SAVIGNANO (ITALY)



Ceramica del Conca undergoes a period of remarkable industrial expansion, with new production plants and upgrades for the production of high-value and extra thick tiles and porcelain slabs.

2014

DEL CONCA USA
LOUDON, TN



Del Conca USA is established in Loudon, TN to combine local production and Italian design, providing creativity, research and technological innovation to better serve North American customers.

Where we are

Del Conca USA is the USA subsidiary of the Del Conca Group. With four factories located in Italy, San Marino and the USA, the Group has a product portfolio containing floor and wall, indoor and outdoor, pavers and porcelain slabs.

Del Conca USA's products are designed in Italy with an eye for North American taste and made in the USA for maximum convenience. The best collections by Del Conca and Faetano are stocked in Loudon, TN, offering additional products from the Del Conca Group.

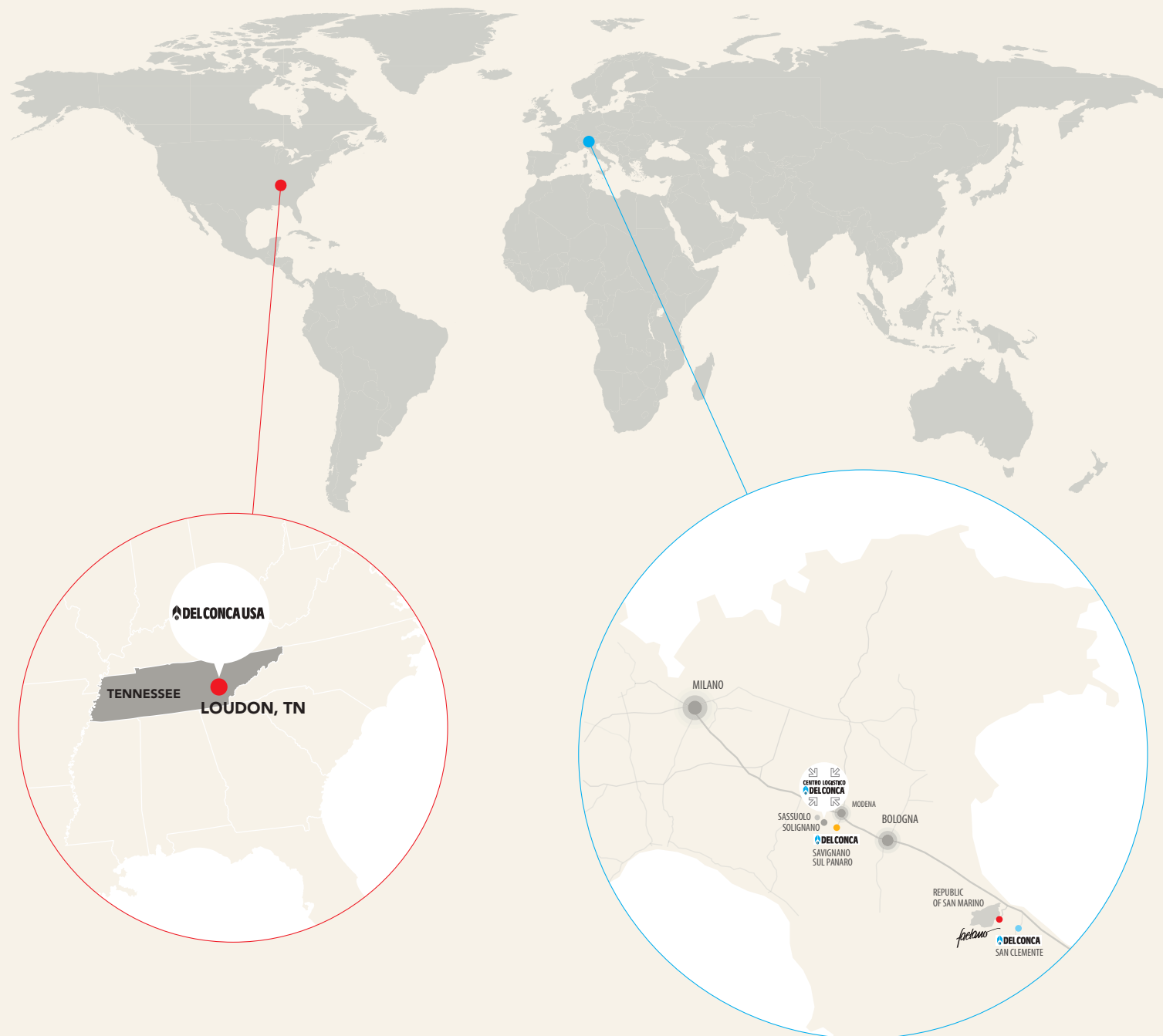

Del Conca USA headquarters



Del Conca USA showroom

Del Conca USA, Inc.
155 Del Conca Way - Loudon, TN 37774 - USA - Tel 865.657.3550 - Fax 865.657.3554
www.delconcausa.com - sales@delconcausa.com

About Del Conca USA

The planning and design of each collection is conceived and carried out in Italy, in the Group's own research facility. An across-the-board creative process, the fruit of intensive teamwork involving designers, laboratory and quality technicians in order to ensure uniquely distinctive products; all made in the USA at the high-tech facility in Loudon, TN, the latest proud achievement of the Del Conca Group. The resulting products, incorporating dynamic taste and the latest trends, are generously endowed with cultural values, beauty and authenticity in order to enhance any architectural, residential or commercial space, both indoor and outdoor.



Product Effect



Marble

Floor: Nature NA02 Fior di Bosco Rect.



Stone

Wall: New England HEN10 White Rect. | Floor: New England HEN10 White Rect.



Concrete

Wall: Essential HET05 Gray Rect. - Nature NA07 Calacatta Gold Rect. - Woodland HWL03 Natural Rect. | Floor: Essential HET05 Gray Rect.
Counter: Essential HET05 Gray Card Mosaic



Wood

Wall: Woodland Essential Design Rect. | Floor: Woodland HWL03 Natural

Various textural effects showcase the projectual vision, offering immediate responses for today's changing context.



Decorative

Wall: Fragrance FR04 Verde Acqua - FR10 Bianco | Floor: Fragrance FR10 Bianco



Brick

Floor: Cantina CA10 Bianco

Technology

Attention to detail, sensitivity to the environment and innovation are necessary to remain faithful to the vocation of producing ceramic tiles. The awareness of a historical and artistic heritage are drawn on for inspiration. An open and active vision of the evolution of the contemporary world, associated with creativity and originality, are the driving forces behind the development of superior quality surfaces that represent high quality Italian design culture.

An innovative production system is used to create porcelain stoneware with high-definition graphics, which is resistant to wear and chemical agents, easy to clean, and is suitable for spaces exposed to strong external stress.



The Del Conca USA factory is a hub of innovation, with state-of-the-art facilities to create the highest quality porcelain tile.

A production system that includes the collaborative effort of all departments is used to create porcelain stoneware with high definition graphics and material benefits.



Our Team

Enthusiasm, energy and commitment are the underlying characteristics shared by the team of dynamic people that are the beating heart of Ceramica del Conca. The creation of a close-knit working group, which believes in the company's values and desire for continuous renewal, is an important resource; this great resource must be nurtured with great care and attention.

The ethical qualities, sense of responsibility and professional skills of each member of the team must be enhanced through refresher and training courses. In this way, through the experience and know-how acquired together with trusted partners and experienced collaborators, the cultural, technological and aesthetic content of the products and services is transformed into something unique, capable of generating and implementing ideas that are always different and innovative.

Social Responsibility

The Del Conca Group has always been active in the social sphere also thanks to the Cino Mularoni Foundation, which aims to organize cultural and scientific events, encouraging studies and research and contributing to the training of young scholars and to supporting various publishing activities.

The Del Conca Group employs human and economic resources to promote a wide number of philanthropic activities, obtaining concrete results in the humanitarian field with solidarity projects all over the world.

Since the first project carried out in Indonesia in 2008, the focus has been on the importance of health and education as a basis for social and economic development of all the poorest countries in the world; since then the company has fully committed to this mission and has moved in that direction through the construction of schools, family houses, water networks, health centers and hospital wards.

Support was also provided to the populations strongly affected by the earthquakes in Italy in 2012 and 2016.



Sustainability

Respect for the environment and natural resources, combined with attention to energy consumption, has always been a key goal which the company pursues. The aim is to offer customers a product that not only has high quality technical and aesthetic features but that is also manufactured according to sustainability criteria. The environmental policy is implemented by raising the awareness of employees and suppliers on ecology and energy saving issues.

The company's environmental philosophy is attentive to the environment and to people's well-being. It is based on the complete internal re-use of the industrial water produced during the company and third-party's processing cycles, the reduction of CO2 emissions into the atmosphere in line with the requirements of the Kyoto Protocol, the recovery of all non-fired production waste during production and proper waste management.



User's Guide

- 1 Name of the collection
- 2 Available sizes
- 3 Collection code
- 4 Colors summary
- 5 Effect
- 6 Technical characteristics
- 7 Graphics number
- 8 Packaging specifications
- 9 Matching Outdoor product (if available)



1

2

3

New England

24"x48" 24"x24" 12"x24"

Rectified Collection



24"x48" - 60x120 cm



24"x24" - 60x60 cm



12"x24" - 30x60 cm

Colored Body Porcelain Stoneware



New England
HEN10 White



New England
HEN01 Ivory



New England
HEN15 Cold Gray



New England
HEN08 Anthracite

ANSI A 137.1 compliant

WALL / FLOOR

MODERATE

0.34 in / 8.6 mm

ASTM E 1105 RESISTANT

ASTM E 333 0.1%

ASTM E 488 CLASS A / ASTM E 1316 CLASS A

ANSI A 325.3.2017 class 37% DICOPI 10/02

REAR USE

Graphics number

Size	New England HEN10 White	New England HEN01 Ivory	New England HEN15 Cold Gray	New England HEN08 Anthracite
24"x48"	10	10	10	10
24"x24"	20	20	20	20
12"x24"	40	40	40	40

Packaging

Size	Pieces	Gross Weight (kg)	Net Weight (kg)	Boxes	Gross Volume (m³)	Net Volume (m³)
24"x48"	7	15.50	11.00	38	118.00	113.00
24"x24"	4	25.20	19.50	24	118.00	113.00
12"x24"	5	15.50	11.00	32	118.00	113.00
12"x12" mosaic	10	9.70	-	-	-	-
12"x12" hexagonal mosaic	10	9.50	-	-	-	-
12"x12" look	10	9.70	-	-	-	-
4"x24" outdoor	10	-	-	-	-	-

HEN

Stone Effect

User's Guide

- 1 Name of the collection
- 2 Available sizes
- 3 Item code
- 4 Item description
- 5 Size in inches and cm
- 6 Collection code
- 7 Effect

1 **2**

































3 **4** **5**

6

New England

24"x48" 24"x24" 12"x24"

Stone Effect

 <p style="font-size: 8px;">GCEN10R New England HEN10 White Rect. 24"x48" - 60x120 cm</p>	 <p style="font-size: 8px;">GCEN10R New England HEN10 White Rect. 12"x24" - 30x60 cm</p>	 <p style="font-size: 8px;">GCEN01R New England HEN01 Ivory Rect. 24"x48" - 60x120 cm</p>	 <p style="font-size: 8px;">GCEN01R New England HEN01 Ivory Rect. 12"x24" - 30x60 cm</p>	 <p style="font-size: 8px;">GCEN05R New England HEN05 Cold Gray Rect. 24"x48" - 60x120 cm</p>	 <p style="font-size: 8px;">GCEN05R New England HEN05 Cold Gray Rect. 12"x24" - 30x60 cm</p>	 <p style="font-size: 8px;">GCEN08R New England HEN08 Anthracite Rect. 24"x48" - 60x120 cm</p>	 <p style="font-size: 8px;">GCEN08R New England HEN08 Anthracite Rect. 12"x24" - 30x60 cm</p>
 <p style="font-size: 8px;">GCEN10B New England HEN10 White Brick* 12"x24" - 30x60 cm</p>	 <p style="font-size: 8px;">GCEN10B New England HEN10 White Brick* 12"x24" - 30x60 cm</p>	 <p style="font-size: 8px;">GCEN01B New England HEN01 Ivory Brick* 12"x24" - 30x60 cm</p>	 <p style="font-size: 8px;">GCEN01B New England HEN01 Ivory Brick* 12"x24" - 30x60 cm</p>	 <p style="font-size: 8px;">GCEN05B New England HEN05 Cold Gray Brick* 12"x24" - 30x60 cm</p>	 <p style="font-size: 8px;">GCEN05B New England HEN05 Cold Gray Brick* 12"x24" - 30x60 cm</p>	 <p style="font-size: 8px;">GCEN08B New England HEN08 Anthracite Brick* 12"x24" - 30x60 cm</p>	 <p style="font-size: 8px;">GCEN08B New England HEN08 Anthracite Brick* 12"x24" - 30x60 cm</p>
 <p style="font-size: 8px;">GCEN10H New England HEN10 White Herringbone Mosaic* 12"x14" - 31x35 cm</p>	 <p style="font-size: 8px;">GCEN10H New England HEN10 White Herringbone Mosaic* 12"x14" - 31x35 cm</p>	 <p style="font-size: 8px;">GCEN01H New England HEN01 Ivory Herringbone Mosaic* 12"x14" - 31x35 cm</p>	 <p style="font-size: 8px;">GCEN01H New England HEN01 Ivory Herringbone Mosaic* 12"x14" - 31x35 cm</p>	 <p style="font-size: 8px;">GCEN05H New England HEN05 Cold Gray Herringbone Mosaic* 12"x14" - 31x35 cm</p>	 <p style="font-size: 8px;">GCEN05H New England HEN05 Cold Gray Herringbone Mosaic* 12"x14" - 31x35 cm</p>	 <p style="font-size: 8px;">GCEN08H New England HEN08 Anthracite Herringbone Mosaic* 12"x14" - 31x35 cm</p>	 <p style="font-size: 8px;">GCEN08H New England HEN08 Anthracite Herringbone Mosaic* 12"x14" - 31x35 cm</p>
 <p style="font-size: 8px;">GCEN10 New England HEN10 White Bullnose 4"x24" - 10x60 cm</p>	 <p style="font-size: 8px;">GCEN10MO New England HEN10 White Mosaic* 12"x12" - 30x30 cm</p>	 <p style="font-size: 8px;">GCEN01 New England HEN01 Ivory Bullnose 4"x24" - 10x60 cm</p>	 <p style="font-size: 8px;">GCEN01MO New England HEN01 Ivory Mosaic* 12"x12" - 30x30 cm</p>	 <p style="font-size: 8px;">GCEN05 New England HEN05 Cold Gray Bullnose 4"x24" - 10x60 cm</p>	 <p style="font-size: 8px;">GCEN05MO New England HEN05 Cold Gray Mosaic* 12"x12" - 30x30 cm</p>	 <p style="font-size: 8px;">GCEN08 New England HEN08 Anthracite Bullnose 4"x24" - 10x60 cm</p>	 <p style="font-size: 8px;">GCEN08MO New England HEN08 Anthracite Mosaic* 12"x12" - 30x30 cm</p>

Stone Effect

79

*More details on page 204-205

71

User's Guide

25

24

Wood Effect

Woodland	28
Woodscape	34
Hardin Valley	40
Voyage	46
Lumber	50
Barton Creek	56

Woodland

8"x48"



8"x48" . 20x120 cm

Colored Body Porcelain Stoneware

ANSI A 137.1 compliant



WALL / FLOOR



MODERATE



0.34 in
8.5 mm



ASTM C 1026
RESISTANT



ASTM C 373
~0.1%



ASTM C 650: CLASS A
ASTM C 1378: CLASS A



ANSI A 326.3:2017 release 2019.
(DCOF): ≥0,42



HEAVY USE

Rectified Collection



Woodland
HWL05 Gray



Woodland
HWL03 Natural

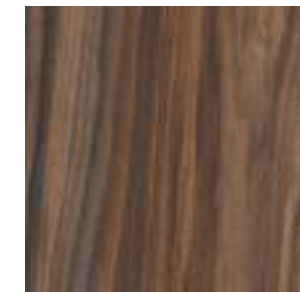



Woodland
HWL09 Walnut

Graphics number

Sizes	Woodland HWL03 Natural	Woodland HWL05 Gray	Woodland HWL09 Walnut
8"x48"	33	33	33

Packaging

Sizes	Pieces					
		Sq.Ft.	Lbs.	Boxes	Sq.Ft.	Lbs.
8"x48"	5	12.92	49.12	48	620.16	2400.00
12"x24" essential design	8	15.50	61.40	32	496.00	1932.48



Woodland

8"x48"

HWL

Wood Effect



Wood Effect

Woodland

8"x48"



Woodland HWL05 Gray Rect. 8"x48"

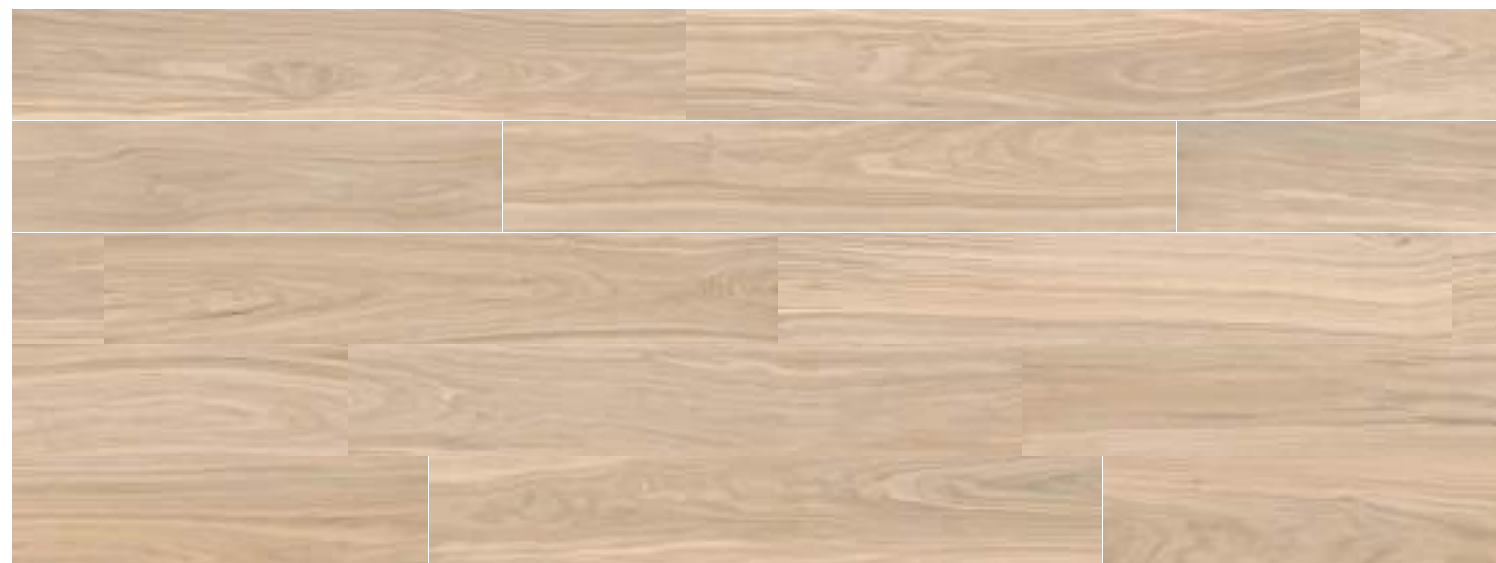

Woodland HWL03 Natural Rect. 8"x48"



Woodland HWL09 Walnut Rect. 8"x48"



GLWL05R
Woodland HWL05 Gray Rect.
8"x48" . 20x120 cm



GLWL03R
Woodland HWL03 Natural Rect.
8"x48" . 20x120 cm



GLWL09R
Woodland HWL09 Walnut Rect.
8"x48" . 20x120 cm



G8ETDESIGNR
Essential Design Rect.
12"x24" . 30x60 cm

The Design decoration can be used in both wall and floor tiles, and also in combination with the Woodland series.



Woodscape

8"x48"



8"x48" . 20x120 cm

Glazed Porcelain Stoneware

Rectified Collection



Woodscape
WS10 Bianco



Woodscape
WS03 Natural



Woodscape
WS05 Gray

ANSI A 137.1 compliant



WALL / FLOOR



MODERATE



0.34 in
8.5 mm



ASTM C 1026
RESISTANT



ASTM C 373
~0.1%



ASTM C 650: CLASS A
ASTM C 1378: CLASS A



ANSI A 326.3:2017 release 2019.
(DCOF): ≥0,42





MEDIUM USE

Graphics number

Sizes	Woodscape WS10 Bianco	Woodscape WS03 Natural	Woodscape WS05 Gray
8"x48"	21	20	21

Packaging

Sizes	Pieces					
		Sq.Ft.	Lbs.	Boxes	Sq.Ft.	Lbs.
8"x48"	5	12.92	49.12	48	620.16	2400.00
12"x12" mosaic	10	9.70	-	-	-	-

Woodscape

8"x48"

WS



Wood Effect

Wood Effect



Floor: Woodscape WS05 Gray Rect. 8"x48"

Woodscape

8"x48"

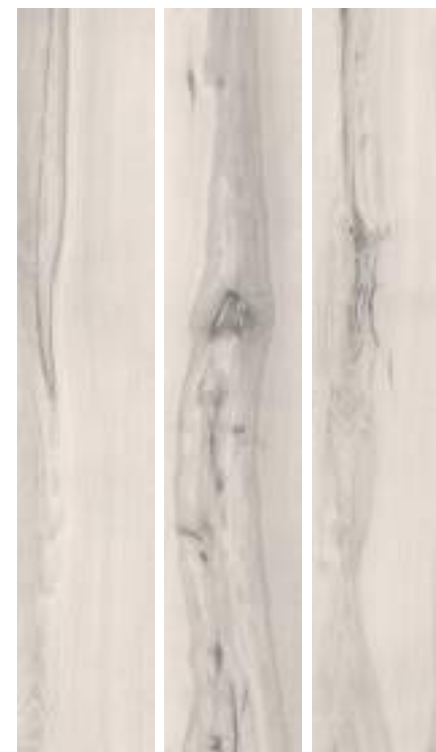

21WS10R
Woodscape WS10 Bianco Rect.
8"x48" . 20x120 cm



21WS03R
Woodscape WS03 Natural Rect.
8"x48" . 20x120 cm



21WS05R
Woodscape WS05 Gray Rect.
8"x48" . 20x120 cm



32WS10MO
Woodscape WS10 Bianco Mosaic*
(sheet 12"x12" . 30x30 cm)



32WS03MO
Woodscape WS03 Natural Mosaic*
(sheet 12"x12" . 30x30 cm)



32WS05MO
Woodscape WS05 Gray Mosaic*
(sheet 12"x12" . 30x30 cm)

*More details on page. 204-205



Hardin Valley

8"x48"



8"x48" . 20x120 cm

Colored Body Porcelain Stoneware

ANSI A 137.1 compliant

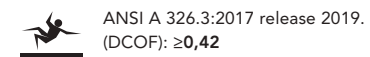

Hardin Valley
HHV10 Bianco



Hardin Valley
HHV03 Natural

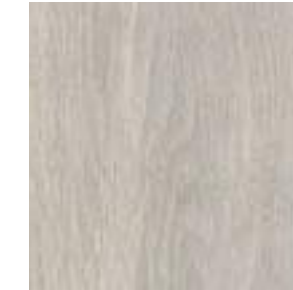

Hardin Valley
HHV05 Gray



Hardin Valley
HHV08 Nero

Graphics number

Sizes	Hardin Valley HHV10 Bianco	Hardin Valley HHV03 Natural	Hardin Valley HHV05 Gray	Hardin Valley HHV08 Nero
8"x48"	20	20	20	20

Packaging

Sizes	Pieces	Sq.Ft.	Lbs.	Boxes	Sq.Ft.	Lbs.
8"x48"	5	12.92	49.12	48	620.16	2400.00

Hardin Valley

8"x48"

HHV

Wood Effect



Wood Effect



Floor: Hardin Valley HHV10 Bianco 8"x48"

Hardin Valley

8"x48"



GLHV10
Hardin Valley HHV10 Bianco
8"x48" . 20x120 cm



GLHV03
Hardin Valley HHV03 Natural
8"x48" . 20x120 cm



GLHV05
Hardin Valley HHV05 Gray
8"x48" . 20x120 cm



GLHV08
Hardin Valley HHV08 Nero
8"x48" . 20x120 cm



Voyage

8"x32" 6"x24"

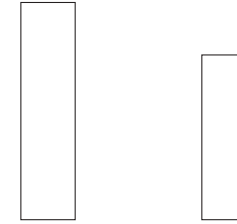

8"x32" . 20x80 cm 6"x24" . 15x60 cm

Glazed Porcelain Stoneware

ANSI A 137.1 compliant



WALL / FLOOR



HIGH



0.34 in
8.5 mm



ASTM C 1026
RESISTANT



ASTM C 373
~0.1%



ASTM C 650: CLASS A
ASTM C 1378: CLASS A



ANSI A 326.3:2017 release 2019.
(DCOF): ≥0,42



MEDIUM USE



Voyage
VO10 Bianco



Voyage
VO07 Taupe



Voyage
VO05 Gray



Voyage
VO13 Dark Brown

Graphics number

Sizes	Voyage VO10 Bianco	Voyage VO07 Taupe	Voyage VO05 Gray	Voyage VO13 Dark Brown
8"x32"	29	29	29	29
6"x24"	58	58	58	58

Packaging

Sizes						
	Pieces	Sq.Ft.	Lbs.	Boxes	Sq.Ft.	Lbs.
8"x32"	7	12.10	47.84	54	653.40	2583.30
6"x24"	16	15.51	60.50	40	620.40	2460.00

Voyage

8"x32" 6"x24"



27VO10
Voyage VO10 Bianco
8"x32" . 20x80 cm



17VO10
Voyage VO10 Bianco
6"x24" . 15x60 cm



27VO05
Voyage VO05 Gray
8"x32" . 20x80 cm



17VO05
Voyage VO05 Gray
6"x24" . 15x60 cm



27VO07
Voyage VO07 Taupe
8"x32" . 20x80 cm



17VO07
Voyage VO07 Taupe
6"x24" . 15x60 cm



27VO13
Voyage VO13 Dark Brown
8"x32" . 20x80 cm



17VO13
Voyage VO13 Dark Brown
6"x24" . 15x60 cm

Floor: Voyage VO10 Bianco 8"x32"



Lumber

6"x24"



6"x24" . 15x60 cm

Glazed Porcelain Stoneware

ANSI A 137.1 compliant



WALL / FLOOR



HIGH



0.34 in
8.5 mm



ASTM C 1026
RESISTANT



ASTM C 373
~0.1%



ASTM C 650: CLASS A
ASTM C 1378: CLASS A



ANSI A 326.3:2017 release 2019.
(DCOF): ≥0,42



MEDIUM USE

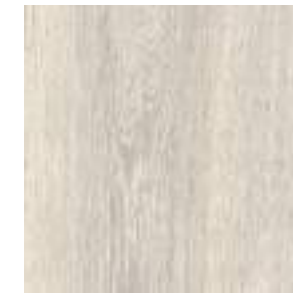

Lumber
LU10 Bianco



Lumber
LU05 Gray



Lumber
LU03 Honey

Graphics number

Sizes	Lumber LU10 Bianco	Lumber LU05 Gray	Lumber LU03 Honey
6"x24"	16	56	20

Packaging

Sizes	Pieces	Sq.Ft.	Lbs.	Boxes	Sq.Ft.	Lbs.
6"x24"	13	12.60	55.14	44	554.40	2426.52

Lumber

6"x24"

Wood Effect



Wood Effect



Wall: Lumber LU05 Gray 6"x24" | Floor: Lumber LU05 Gray 6"x24"

Lumber

6"x24"



17LU10
Lumber LU10 Bianco
6"x24" . 15x60 cm

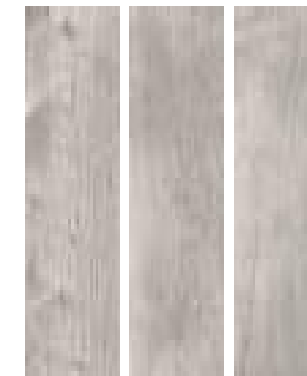

17LU05
Lumber LU05 Gray
6"x24" . 15x60 cm



17LU03
Lumber LU03 Honey
6"x24" . 15x60 cm



Barton Creek

8"x32"



8"x32" . 20x80 cm

Glazed Porcelain Stoneware



Barton Creek
BC05 Gray



Barton Creek
BC01 Beige

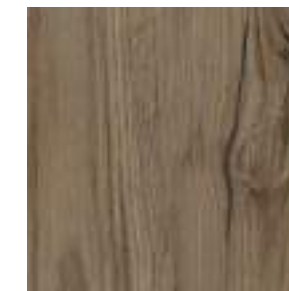

Barton Creek
BC09 Noce

ANSI A 137.1 compliant



WALL / FLOOR



HIGH



0.34 in
8.5 mm



ASTM C 1026
RESISTANT



ASTM C 373
~0.1%



ASTM C 650: CLASS A
ASTM C 1378: CLASS A



ANSI A 326.3:2017 release 2019.
(DCOF): ≥0,42



MEDIUM USE

Graphics number

Sizes	Barton Creek BC05 Gray	Barton Creek BC01 Beige	Barton Creek BC09 Noce
8"x32"	15	28	16

Packaging

Sizes	Pieces	Sq.Ft.	Lbs.	Boxes	Sq.Ft.	Lbs.
8"x32"	7	12.10	47.84	54	653.40	2583.30

Barton Creek

8"x32"

BC

Wood Effect



Wood Effect

Barton Creek

8"x32"



27BC05
Barton Creek BC05 Gray
8"x32" . 20x80 cm



27BC01
Barton Creek BC01 Beige
8"x32" . 20x80 cm



27BC09
Barton Creek BC09 Noce
8"x32" . 20x80 cm

Wood Effect



Wood Effect

Stone Effect

New England	64
Verona	72
Quartzite	80
Navona	88
Chamonix	96
West 57th	106
Neopolis	116
Gotham	122

New England

24"x48" 24"x24" 12"x24"

Rectified Collection

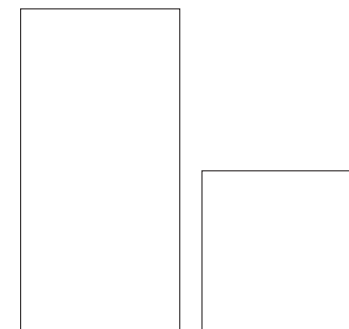

24"x48" . 60x120 cm 24"x24" . 60x60 cm



12"x24" . 30x60 cm

Colored Body Porcelain Stoneware

ANSI A 137.1 compliant



WALL / FLOOR



MODERATE



0.34 in
8.5 mm



ASTM C 1026
RESISTANT



ASTM C 373
~0.1%



ASTM C 650: CLASS A
ASTM C 1378: CLASS A



ANSI A 326.3:2019 release 2019.
(DCOF): ≥0,42



HEAVY USE



New England
HEN10 White



New England
HEN01 Ivory



New England
HEN05 Cold Gray

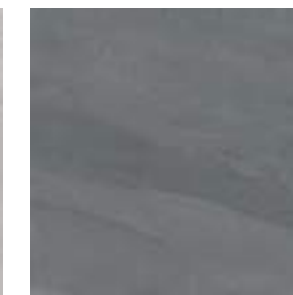

New England
HEN08 Anthracite

Graphics number

Sizes	New England HEN10 White	New England HEN01 Ivory	New England HEN05 Cold Gray	New England HEN08 Anthracite
24"x48"	10	10	10	10
24"x24"	20	20	20	20
12"x24"	40	40	40	40

Packaging

Sizes	Pieces					
		Sq.Ft.	Lbs.	Boxes	Sq.Ft.	Lbs.
24"x48"	2	15.50	61.00	36	558.00	2236.00
24"x24"	6	23.25	91.50	24	558.00	2236.00
12"x24"	8	15.50	61.40	32	496.00	1932.48
12"x12" mosaic	10	9.70	-	-	-	-
12"x14" herringbone mosaic	10	8.60	-	-	-	-
12"x12" brick	10	9.70	-	-	-	-
4"x24" bullnose	10	-	-	-	-	-

New England ²

due2 Porcelain Pavers available
in White, Ivory, Cold Gray

Stone Effect



Wall: New England HEN08 Anthracite Herringbone Mosaic 12"x14" (sheet) | Floor: New England HEN08 Anthracite Rect. 24"x48"

New England

24"x48" 24"x24" 12"x24"

Stone Effect



Stone Effect

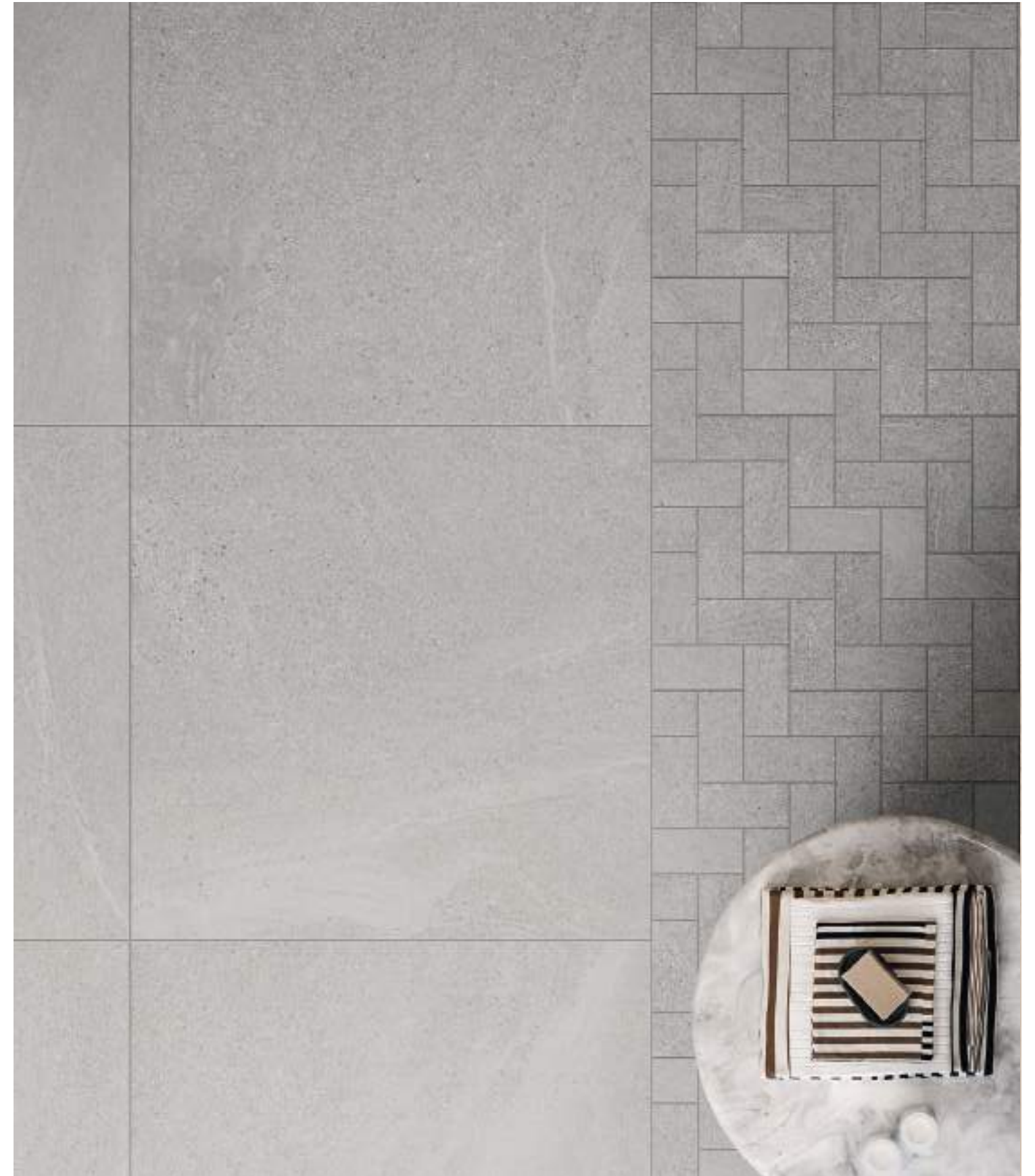

New England

24"x48" 24"x24" 12"x24"

Stone Effect



68 Wall: New England HEN01 Ivory Rect. 24"x48" - New England HEN01 Ivory Brick 12"x12" (sheet) | Floor: New England HEN01 Ivory Rect. 24"x48"



Stone Effect

69 Wall: New England HEN10 White Rect. 24"x24" | Floor: New England HEN10 White Rect. 24"x24"

New England

24"x48" 24"x24" 12"x24"

Stone Effect



G8EN10R
New England
HEN10 White Rect.
12"x24" . 30x60 cm



G3EN10BR
New England
HEN10 White Brick*
17/8"x 37/8" . 4,7x9,7 cm
(sheet 12"x12" 30x30 cm)



G8EN01R
New England
HEN01 Ivory Rect.
12"x24" . 30x60 cm



G3EN01BR
New England
HEN01 Ivory Brick*
17/8"x 37/8" . 4,7x9,7 cm
(sheet 12"x12" 30x30 cm)



G8EN05R
New England
HEN05 Cold Gray Rect.
12"x24" . 30x60 cm



G3EN05BR
New England
HEN05 Cold Gray Brick*
17/8"x 37/8" . 4,7x9,7 cm
(sheet 12"x12" 30x30 cm)



G8EN08R
New England
HEN08 Anthracite Rect.
12"x24" . 30x60 cm



G3EN08BR
New England
HEN08 Anthracite Brick*
17/8"x 37/8" . 4,7x9,7 cm
(sheet 12"x12" 30x30 cm)



G3EN10HB
New England
HEN10 White Herringbone Mosaic*
17/8"x 37/8" . 4,7x9,7 cm
(sheet 12"x14" . 31x35 cm)



G3EN01HB
New England
HEN01 Ivory Herringbone Mosaic*
17/8"x 37/8" . 4,7x9,7 cm
(sheet 12"x14" . 31x35 cm)



G3EN05HB
New England
HEN05 Cold Gray Herringbone Mosaic*
17/8"x 37/8" . 4,7x9,7 cm
(sheet 12"x14" . 31x35 cm)



G3EN08HB
New England
HEN08 Anthracite Herringbone Mosaic*
17/8"x 37/8" . 4,7x9,7 cm
(sheet 12"x14" . 31x35 cm)



G3EN10MO
New England
HEN10 White Mosaic*
13/8"x 13/8" . 3,5x3,5 cm
(sheet 12"x12" . 30x30 cm)



G3EN01MO
New England
HEN01 Ivory Mosaic*
13/8"x 13/8" . 3,5x3,5 cm
(sheet 12"x12" . 30x30 cm)



G3EN05MO
New England
HEN05 Cold Gray Mosaic*
13/8"x 13/8" . 3,5x3,5 cm
(sheet 12"x12" . 30x30 cm)



G3EN08MO
New England
HEN08 Anthracite Mosaic*
13/8"x 13/8" . 3,5x3,5 cm
(sheet 12"x12" . 30x30 cm)

Stone Effect



Verona

12"x24"

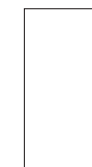

12"x24" . 30x60 cm

Glazed Porcelain Stoneware

ANSI A 137.1 compliant



WALL / FLOOR



LOW



0.34 in
8.5 mm



ASTM C 1026
RESISTANT



ASTM C 373
~0.1%



ASTM C 650: CLASS A
ASTM C 1378: CLASS A



ANSI A 326.3:2017 release 2019.
(DCOF): ≥0,42



MEDIUM USE

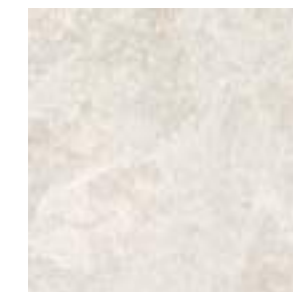

Verona
VR10 Bianco



Verona
VR01 Cream



Verona
VR05 Gray

Graphics number

Sizes	Verona VR10 Bianco	Verona VR01 Cream	Verona VR05 Gray
12"x24"	32	32	32

Packaging

Sizes	Pieces					
		Sq.Ft.	Lbs.	Boxes	Sq.Ft.	Lbs.
12"x24"	8	15.50	61.40	32	497.28	1965.00
12"x12" mosaic	10	9.70	-	-	-	-
3"x12" bullnose	20	-	-	-	-	-

Verona

12"x24"

VR

Stone Effect



74 Wall: Verona VR05 Gray 12"x24" - Verona VR05 Gray Mosaic 12"x12" (sheet) | Floor: Verona VR05 Gray 12"x24" - Verona VR05 Gray Mosaic 12"x12" (sheet)



Stone Effect

75 Wall: Verona VR05 Gray 12"x24" | Counter Top: Verona VR05 Gray Mosaic 12"x12" (sheet)

Verona

12"x24"

VR

Stone Effect



Stone Effect



Wall: Verona VR01 Cream 12"x24" | Floor: Verona VR01 Cream 12"x24"

Verona

12"x24"



63VR10
Verona VR10 Bianco
12"x24" . 30x60 cm



63VR01
Verona VR01 Cream
12"x24" . 30x60 cm



63VR05
Verona VR05 Gray
12"x24" . 30x60 cm



32VR10MO
Verona VR10 Bianco Mosaic*
(sheet 12"x12" . 30x30 cm)



32VR01MO
Verona VR01 Cream Mosaic*
(sheet 12"x12" . 30x30 cm)



32VR05MO
Verona VR05 Gray Mosaic*
(sheet 12"x12" . 30x30 cm)



13VR10
Verona VR10 Bianco Bullnose
3"x12" . 8x30 cm



13VR01
Verona VR01 Cream Bullnose
3"x12" . 8x30 cm



13VR05
Verona VR05 Gray Bullnose
3"x12" . 8x30 cm

*More details on page. 204-205



Quartzite

24"x48" 12"x48" 12"x24" 4"x12" Rectified Collection

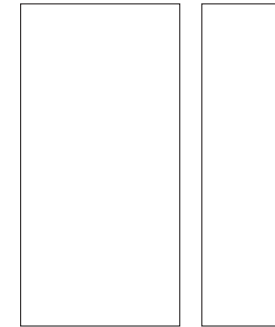

24"x48" . 60x120 cm 12"x48" . 30x120 cm



12"x24" . 30x60 cm 4"x12" . 10x30 cm

Colored Body Porcelain Stoneware

ANSI A 137.1 compliant



WALL / FLOOR



MODERATE



0.34 in
8.5 mm



ASTM C 1026
RESISTANT



ASTM C 373
~0.1%



ASTM C 650: CLASS A
ASTM C 1378: CLASS A



ANSI A 326.3:2019 release 2019.
(DCOF): ≥0,42
Grip: (DCOF): ≥0,42



HEAVY USE



Quartzite
HQT10 Bianco

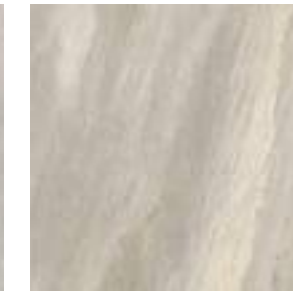

Quartzite
HQT01 Sand



Quartzite
HQT05 Gray

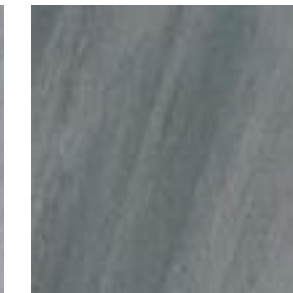

Quartzite
HQT08 Dark Gray

Graphics number

Sizes	Quartzite HQT10 Bianco	Quartzite HQT01 Sand	Quartzite HQT05 Gray	Quartzite HQT08 Dark Gray
24"x48"	8	8	8	8
12"x48"	16	16	16	16
12"x24"	32	32	32	32

Packaging

Sizes	Pieces					
		Sq.Ft.	Lbs.	Boxes	Sq.Ft.	Lbs.
24"x48"	2	15.50	61.00	36	558.00	2236.00
12"x48"	3	11.62	45.75	54	627.75	2340.00
12"x24"	8	15.50	61.40	32	496.00	1932.48
4"x12"	36	11.65	46,45	40	466.00	1858.00
12"x12" mosaic	10	9.70	-	-	-	-
12"x12" muretto wall	10	9.70	-	-	-	-
4"x24" bullnose	10	-	-	-	-	-

Quartzite 2

due2 Porcelain Pavers available

Quartzite

24"x48" 12"x48" 12"x24" 4"x12"

HOT



Stone Effect

Stone Effect

Quartzite

24"x48" 12"x48" 12"x24" 4"x12"

HOT



Stone Effect

Stone Effect

Quartzite

24"x48" 12"x48" 12"x24" 4"x12"

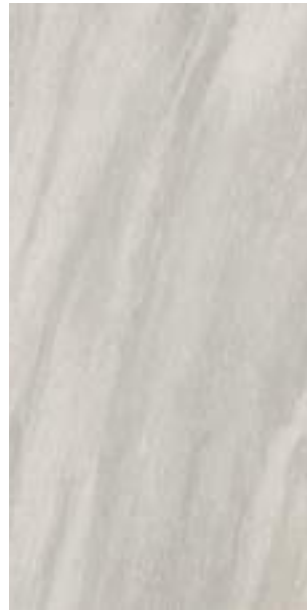

GCQT10R
Quartzite HQT10 Bianco Rect.
24"x48" . 60x120 cm



GMQT10R
Quartzite HQT10 Bianco Rect.
12"x48" . 30x120 cm



GCQT01R
Quartzite HQT01 Sand Rect.
24"x48" . 60x120 cm



GMQT01R
Quartzite HQT01 Sand Rect.
12"x48" . 30x120 cm

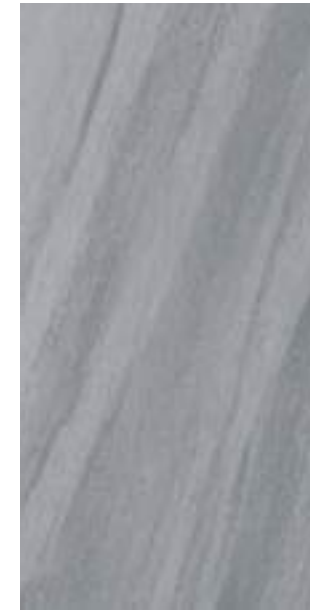

GCQT05R
Quartzite HQT05 Gray Rect.
24"x48" . 60x120 cm



GMQT05R
Quartzite HQT05 Gray Rect.
12"x48" . 30x120 cm



GCQT08R
Quartzite HQT08 Dark Gray Rect.
24"x48" . 60x120 cm



GMQT08R
Quartzite HQT08 Dark Gray Rect.
12"x48" . 30x120 cm



G8QT10R
Quartzite HQT10 Bianco Rect.
12"x24" . 30x60 cm



30QT10
Quartzite HQT10 Bianco
4"x12" . 10x30 cm



G8QT01R
Quartzite HQT01 Sand Rect.
12"x24" . 30x60 cm



30QT01
Quartzite HQT01 Sand
4"x12" . 10x30 cm



G8QT05R
Quartzite HQT05 Gray Rect.
12"x24" . 30x60 cm



30QT05
Quartzite HQT05 Gray
4"x12" . 10x30 cm



G8QT08R
Quartzite HQT08 Dark Gray Rect.
12"x24" . 30x60 cm



30QT08
Quartzite HQT08 Dark Gray
4"x12" . 10x30 cm



G8QT10GRIR
Quartzite
HQT10 Bianco **Grip** Rect.
12"x24" . 30x60 cm

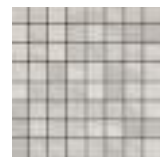

G3QT10MO
Quartzite
HQT10 Bianco Mosaic*
(sheet 12"x12" . 30x30 cm)



G8QT01GRIR
Quartzite
HQT01 Sand **Grip** Rect.
12"x24" . 30x60 cm



G3QT01MO
Quartzite
HQT01 Sand Mosaic*
(sheet 12"x12" . 30x30 cm)



G8QT05GRIR
Quartzite
HQT05 Gray **Grip** Rect.
12"x24" . 30x60 cm

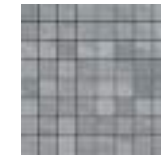

G3QT05MO
Quartzite
HQT05 Gray Mosaic*
(sheet 12"x12" . 30x30 cm)



G8QT08GRIR
Quartzite
HQT08 Dark Gray **Grip** Rect.
12"x24" . 30x60 cm



G3QT08MO
Quartzite
HQT08 Dark Gray Mosaic*
(sheet 12"x12" . 30x30 cm)



G0QT10
Quartzite
HQT10 Bianco Bullnose
4"x24" . 10x60 cm



G3QT10MU
Quartzite
HQT10 Bianco Muretto Wall*
(sheet 12"x12" . 30x30 cm)



G0QT01
Quartzite
HQT01 Sand Bullnose
4"x24" . 10x60 cm



G3QT01MU
Quartzite
HQT01 Sand Muretto Wall*
(sheet 12"x12" . 30x30 cm)



G0QT05
Quartzite
HQT05 Gray Bullnose
4"x24" . 10x60 cm



G3QT05MU
Quartzite
HQT05 Gray Muretto Wall*
(sheet 12"x12" . 30x30 cm)



G0QT08
Quartzite
HQT08 Dark Gray Bullnose
4"x24" . 10x60 cm



G3QT08MU
Quartzite
HQT08 Dark Gray Muretto Wall*
(sheet 12"x12" . 30x30 cm)



Navona

24"x48" 12"x48" 12"x24" 4"x12" Rectified Collection

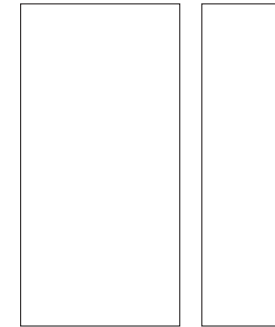

24"x48" . 60x120 cm 12"x48" . 30x120 cm



12"x24" . 30x60 cm 4"x12" . 10x30 cm

Glazed Porcelain Stoneware

ANSI A 137.1 compliant



WALL / FLOOR



MODERATE



0.34 in
8.5 mm



ASTM C 1026
RESISTANT



ASTM C 373
~0.1%



ASTM C 650: CLASS A
ASTM C 1378: CLASS A



ANSI A 326.3:2019 release 2019.
(DCOF): ≥0,42



HEAVY USE



Navona
NV10 Bianco

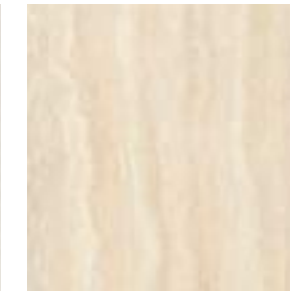

Navona
NV01 Sabbia

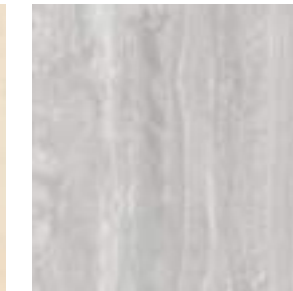

Navona
NV05 Grigio

Graphics number

Sizes	Navona NV10 Bianco	Navona NV01 Sabbia	Navona NV05 Grigio
24"x48"	10	10	10
12"x48"	20	20	20
12"x24"	40	40	40

Packaging

Sizes	Pieces	Sq.Ft.		Boxes		
		Sq.Ft.	Lbs.	Sq.Ft.	Sq.Ft.	Lbs.
24"x48"	2	15.50	61.00	36	558.00	2236.00
12"x48"	3	11.62	45.75	54	627.75	2340.00
12"x24"	8	15.50	61.40	32	496.00	1932.48
4"x12"	36	11.65	46,45	40	466.00	1858.00
12"x12" mosaic	10	9.70	-	-	-	-
12"x12" muretto wall	10	9.70	-	-	-	-
4"x24" bullnose	10	-	-	-	-	-

Navona

24"x48" 12"x48" 12"x24" 4"x12"

Stone Effect



Stone Effect

Navona

24"x48" 12"x48" 12"x24" 4"x12"

NV



Stone Effect

Stone Effect

Navona

24"x48" 12"x48" 12"x24" 4"x12"



80NV10R
Navona NV10 Bianco Rect.
24"x48" . 60x120 cm



31NV10R
Navona NV10 Bianco Rect.
12"x48" . 30x120 cm



80NV01R
Navona NV01 Sabbia Rect.
24"x48" . 60x120 cm



31NV01R
Navona NV01 Sabbia Rect.
12"x48" . 30x120 cm



80NV05R
Navona NV05 Grigio Rect.
24"x48" . 60x120 cm



31NV05R
Navona NV05 Grigio Rect.
12"x48" . 30x120 cm



63NV10R
Navona NV10 Bianco Rect.
12"x24" . 30x60 cm



30NV10
Navona NV10 Bianco
4"x12" . 10x30 cm



63NV01R
Navona NV01 Sabbia Rect.
12"x24" . 30x60 cm



30NV01
Navona NV01 Sabbia
4"x12" . 10x30 cm



63NV05R
Navona NV05 Grigio Rect.
12"x24" . 30x60 cm



30NV05
Navona Grigio
4"x12" . 10x30 cm



32NV10MO
Navona NV10 Bianco Mosaic*
(sheet 12"x12" . 30x30 cm)



32NV10MU
Navona NV10 Bianco Muretto Wall*
(sheet 12"x12" . 30x30 cm)

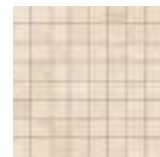

32NV01MO
Navona NV01 Sabbia Mosaic*
(sheet 12"x12" . 30x30 cm)



32NV01MU
Navona NV01 Sabbia Muretto Wall*
(sheet 12"x12" . 30x30 cm)



32NV05MO
Navona NV05 Grigio Mosaic*
(sheet 12"x12" . 30x30 cm)



32NV05MU
Navona NV05 Grigio Muretto Wall*
(sheet 12"x12" . 30x30 cm)



13NV10
Navona NV10 Bianco Bullnose
4"x24" . 10x60 cm



13NV01
Navona NV01 Sabbia Bullnose
4"x24" . 10x60 cm



13NV05
Navona NV05 Grigio Bullnose
4"x24" . 10x60 cm

Stone Effect

Stone Effect



Chamonix

24"x48" 24"x24" 12"x24"

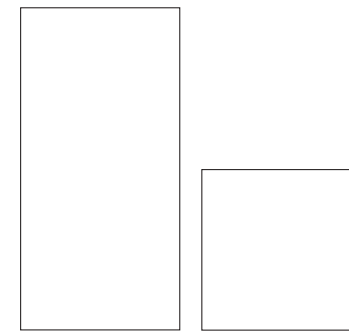

24"x48" . 60x120 cm 24"x24" . 60x60 cm



12"x24" . 30x60 cm

Colored Body Porcelain Stoneware

ANSI A 137.1 compliant



WALL / FLOOR



MODERATE



0.34 in
8.5 mm



ASTM C 1026
RESISTANT



ASTM C 373
~0.1%



ASTM C 650: CLASS A
ASTM C 1378: CLASS A



ANSI A 326.3:2017 release 2019.
(DCOF): ≥0,42



HEAVY USE

Rectified Collection



Chamonix
HCX10 Bianco

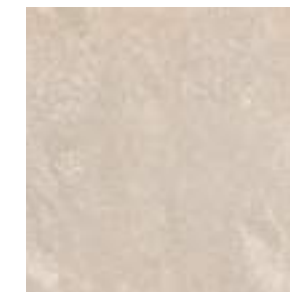

Chamonix
HCX01 Beige



Chamonix
HCX05 Gray



Chamonix
HCX08 Dark Gray

Graphics number

Sizes	Chamonix HCX10 Bianco	Chamonix HCX01 Beige	Chamonix HCX05 Gray	Chamonix HCX08 Dark Gray
24"x48"	10	10	10	10
24"x24"	20	20	20	20
12"x24"	40	40	40	40

Packaging

Sizes	Pieces					
		Sq.Ft.	Lbs.	Boxes	Sq.Ft.	Lbs.
24"x48"	2	15.50	61.00	36	558.00	2236.00
24"x24"	6	23.25	91.50	24	558.00	2236.00
12"x24"	8	15.50	61.40	32	496.00	1932.48
12"x12" mosaic	10	9.70	-	-	-	-
10"x12" hexagon	10	8.40	-	-	-	-
12"x24" muretto brick	4	7.75	-	-	-	-
4"x24" bullnose	10	-	-	-	-	-

Chamonix **2**

due2 Porcelain Pavers available

Chamonix

24"x48" 24"x24" 12"x24"

HCX

Stone Effect



Stone Effect

Chamonix

24"x48" 24"x24" 12"x24"

Stone Effect



Stone Effect

Chamonix

24"x48" 24"x24" 12"x24"

Stone Effect

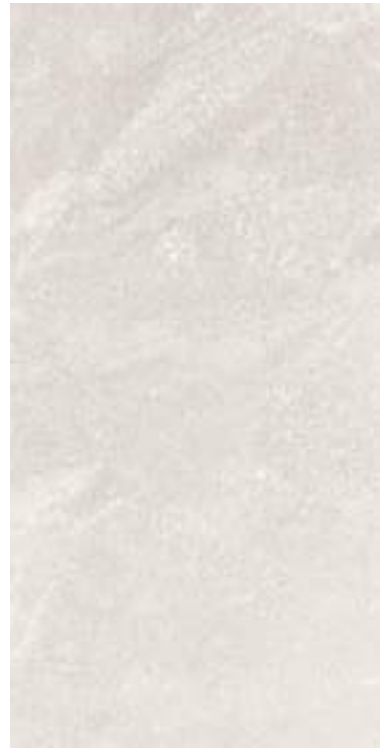

GCCX10R
Chamonix HCX10 Bianco Rect.
24"x48" . 60x120 cm



G8CX10R
Chamonix HCX10 Bianco Rect.
12"x24" . 30x60 cm



G9CX10R
Chamonix HCX10 Bianco Rect.
24"x24" . 60x60 cm

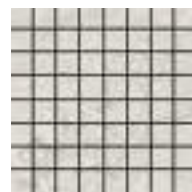

G3CX10MO
Chamonix HCX10 Bianco Mosaic*
(sheet 12"x12" . 30x30 cm)



G3CX10HEX1
Chamonix HCX10 Bianco Hexagon*
(sheet 10"x12" 26x30 cm)



G8CX10MU
Chamonix HCX10 Bianco Muretto Brick*
12"x24" . 30x60 cm



G0CX10
Chamonix HCX10 Bianco Bullnose
4"x24" . 10x60 cm



GCCX01R
Chamonix HCX01 Beige Rect.
24"x48" . 60x120 cm



G8CX01R
Chamonix HCX01 Beige Rect.
12"x24" . 30x60 cm



G9CX01R
Chamonix HCX01 Beige Rect.
24"x24" . 60x60 cm

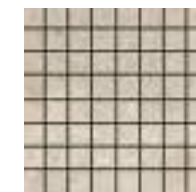

G3CX01MO
Chamonix HCX01 Beige Mosaic*
(sheet 12"x12" . 30x30 cm)



G3CX01HEX1
Chamonix HCX01 Beige Hexagon*
(sheet 10"x12" 26x30 cm)



G8CX01MU
Chamonix HCX01 Beige Muretto Brick*
12"x24" . 30x60 cm



G0CX01
Chamonix HCX01 Beige Bullnose
4"x24" . 10x60 cm

Stone Effect

Chamonix

24"x48" 24"x24" 12"x24"

Stone Effect



GCCX05R
Chamonix HCX05 Gray Rect.
24"x48" . 60x120 cm



G8CX05R
Chamonix HCX05 Gray Rect.
12"x24" . 30x60 cm



G9CX05R
Chamonix HCX05 Gray Rect.
24"x24" . 60x60 cm



G3CX05MO
Chamonix HCX05 Gray Mosaic*
(sheet 12"x12" . 30x30 cm)



G3CX05HEX1
Chamonix HCX05 Gray Hexagon*
(sheet 10"x12" 26x30 cm)



G8CX05MU
Chamonix HCX05 Gray Muretto Brick*
12"x24" . 30x60 cm



G0CX05
Chamonix HCX05 Gray Bullnose
4"x24" . 10x60 cm



GCCX08R
Chamonix HCX08 Dark Gray Rect.
24"x48" . 60x120 cm



G8CX08R
Chamonix HCX08 Dark Gray Rect.
12"x24" . 30x60 cm



G9CX08R
Chamonix HCX08 Dark Gray Rect.
24"x24" . 60x60 cm



G3CX08MO
Chamonix HCX08 Dark Gray Mosaic*
(sheet 12"x12" . 30x30 cm)



G3CX08HEX1
Chamonix HCX08 Dark Gray Hexagon*
(sheet 10"x12" 26x30 cm)



G8CX08MU
Chamonix HCX08 Dark Gray Muretto Brick*
12"x24" . 30x60 cm



G0CX08
Chamonix HCX08 Dark Gray Bullnose
4"x24" . 10x60 cm

Stone Effect



West 57th

12"x24"

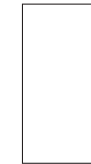

12"x24" . 30x60 cm

Colored Body Porcelain Stoneware

ANSI A 137.1 compliant



WALL / FLOOR



MODERATE



0.34 in
8.5 mm



ASTM C 1026
RESISTANT



ASTM C 373
~0.1%



ASTM C 650: CLASS A
ASTM C 1378: CLASS A



ANSI A 326.3:2017 release 2019.
(DCOF): ≥0,42



HEAVY USE

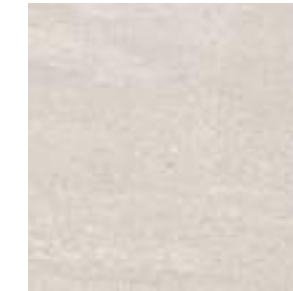

West 57th
HWS10 Bianco



West 57th
HWS01 Beige



West 57th
HWS05 Gray



West 57th
HWS13 Moka

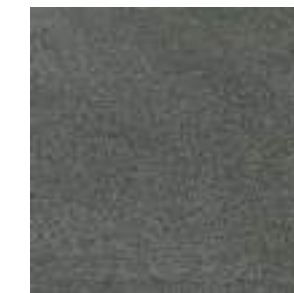

West 57th
HWS08 Nero

Graphics number

Sizes	West 57th HWS10 Bianco	West 57th HWS01 Beige	West 57th HWS05 Gray	West 57th HWS13 Moka	West 57th HWS08 Nero
12"x24"	38	48	48	48	48

Packaging

Sizes	Pieces					
		Sq.Ft.	Lbs.	Boxes	Sq.Ft.	Lbs.
12"x24"	8	15.54	61.40	32	497.28	1965.00
12"x12" mosaic	10	9.70	36.00	-	-	-
12"x24" muretto	4	7.75	29.73	-	-	-
3"x24" bullnose	10	-	-	-	-	-

West 57th 2

due2 Porcelain Pavers available
in Bianco, Gray

West 57th

12"x24"

Stone Effect



Stone Effect



Floor: West 57th HWS13 Moka 12"x24"

West 57th

12"x24"



G8WS10
West 57th HWS10 Bianco
12"x24" . 30x60 cm

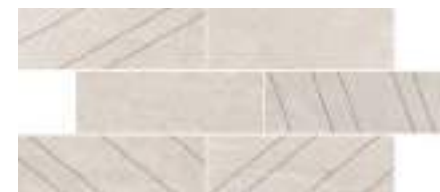

G8WS10MU
West 57th HWS10 Bianco Muretto*
12"x24" . 30x60 cm



G3WS10MO
West 57th HWS10 Bianco Mosaic*
(sheet 12"x12" . 30x30 cm)



G0WS10
West 57th HWS10 Bianco Bullnose
3"x24" . 7,5x60 cm

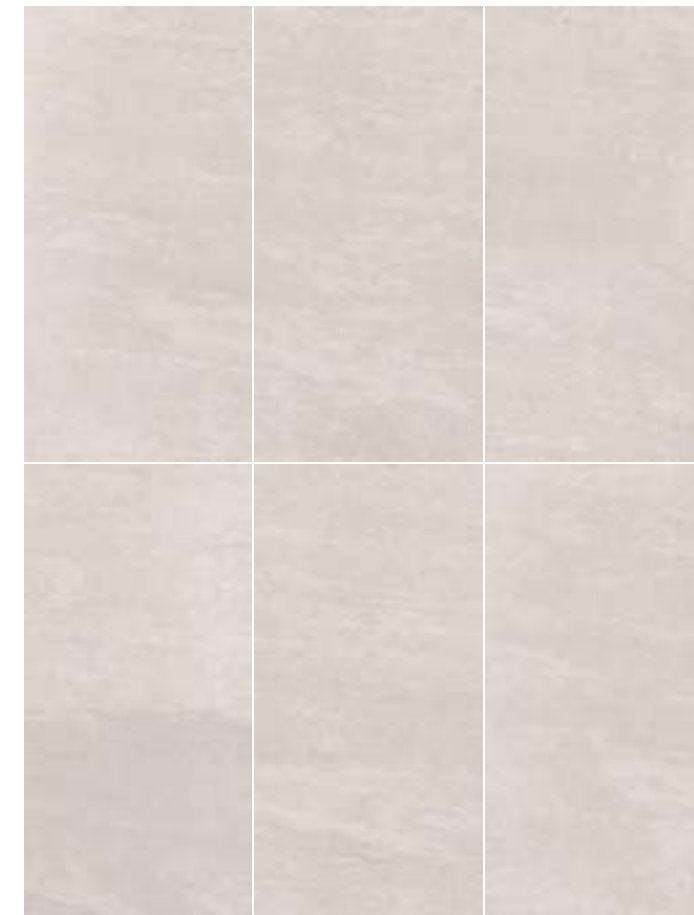

*More details on page. 204-205

West 57th

12"x24"



G8WS01
West 57th HWS01 Beige
12"x24" . 30x60 cm



G8WS01MU
West 57th HWS01 Beige Muretto*
12"x24" . 30x60 cm



G3WS01MO
West 57th HWS01 Beige Mosaic*
(sheet 12"x12" . 30x30 cm)



G0WS01
West 57th HWS01 Beige Bullnose
3"x24" . 7,5x60 cm



G8WS05
West 57th HWS05 Gray
12"x24" . 30x60 cm



G8WS05MU
West 57th HWS05 Gray Muretto*
12"x24" . 30x60 cm



G3WS05MO
West 57th HWS05 Gray Mosaic*
(sheet 12"x12" . 30x30 cm)



G0WS05
HWS05 Gray Bullnose
3"x24" . 7,5x60 cm



Stone Effect

Stone Effect

West 57th

12"x24"



G8WS13
West 57th HWS13 Moka
12"x24" . 30x60 cm



G8WS13MU
West 57th HWS13 Moka Muretto*
12"x24" . 30x60 cm



G3WS13MO
West 57th HWS13 Moka Mosaic*
(sheet 12"x12" . 30x30 cm)



G0WS13
West 57th HWS13 Moka Bullnose
3"x24" . 7,5x60 cm



G8WS08
West 57th HWS08 Nero
12"x24" . 30x60 cm



G8WS08MU
West 57th HWS08 Nero Muretto*
12"x24" . 30x60 cm



G3WS08MO
West 57th HWS08 Nero Mosaic*
(sheet 12"x12" . 30x30 cm)



G0WS08
HWS08 Nero Bullnose
3"x24" . 7,5x60 cm

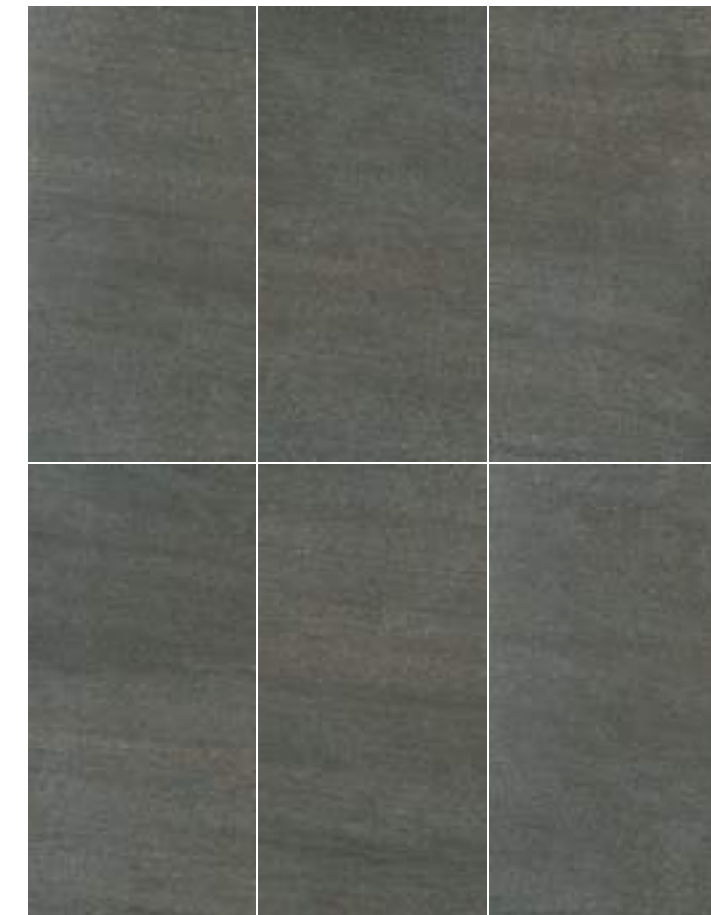

Neopolis

12"x24" 4"x12"



12"x24" . 30x60 cm



4"x12" . 10x30 cm

Glazed Porcelain Stoneware

ANSI A 137.1 compliant



WALL / FLOOR



MODERATE



0.28 in
7 mm



ASTM C 1026
RESISTANT



ASTM C 373
~0.1%



ASTM C 650: CLASS A
ASTM C 1378: CLASS A



ANSI A 326.3:2017 release 2019.
(DCOF): ≥0,42



MEDIUM USE



Neopolis
NE10 Bianco



Neopolis
NE01 Beige



Neopolis
NE13 Moka





Neopolis
NE05 Gray

Graphics number

Sizes	Neopolis NE10 Bianco	Neopolis NE01 Beige	Neopolis NE13 Moka	Neopolis NE05 Gray
12"x24"	36	35	35	30

Packaging

Sizes	Pieces					
		Sq.Ft.	Lbs.	Boxes	Sq.Ft.	Lbs.
12"x24"	9	17.44	60.39	32	557.98	1932.48
4"x12"	36	11.65	40.55	36	419.00	1459.80
12"x12" mosaic	10	9.70	35.82	-	-	-
12"x14" capri mosaic	6	6.78	21.60	-	-	-
3"x12" bullnose	20	-	-	-	-	-



Neopolis

12"x24" 4"x12"

NE

Stone Effect



Stone Effect

Neopolis

12"x24" 4"x12"

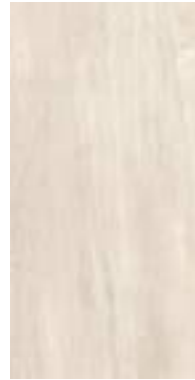

63NE10
Neopolis NE10 Bianco
12"x24" . 30x60 cm



30NE10
Neopolis NE10 Bianco
4"x12" . 10x30 cm

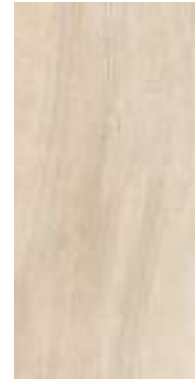

63NE01
Neopolis NE01 Beige
12"x24" . 30x60 cm



30NE01
Neopolis NE01 Beige
4"x12" . 10x30 cm



63NE13
Neopolis NE13 Moka
12"x24" . 30x60 cm



30NE13
Neopolis NE13 Moka
4"x12" . 10x30 cm



63NE05
Neopolis NE05 Gray
12"x24" . 30x60 cm



30NE05
Neopolis NE05 Gray
4"x12" . 10x30 cm

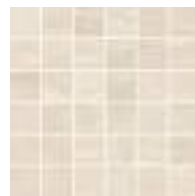

32NE10MO
Neopolis NE10 Bianco Mosaic*
(sheet 12"x12" . 30x30 cm)



32NE10MO1
Neopolis
NE10 Bianco Capri Mosaic*
(sheet 12"x14" . 30x36 cm)



32NE01MO
Neopolis NE01 Beige Mosaic*
(sheet 12"x12" . 30x30 cm)



32NE01MO1
Neopolis
NE01 Beige Capri Mosaic*
(sheet 12"x14" . 30x36 cm)



32NE13MO
Neopolis NE13 Moka Mosaic*
(sheet 12"x12" . 30x30 cm)



32NE13MO1
Neopolis
NE13 Moka Capri Mosaic*
(sheet 12"x14" . 30x36 cm)



32NE05MO
Neopolis NE05 Gray Mosaic*
(sheet 12"x12" . 30x30 cm)



32NE05MO1
Neopolis
NE05 Gray Capri Mosaic*
(sheet 12"x14" . 30x36 cm)



13NE10
Neopolis NE10 Bianco Bullnose
3"x12" . 8x30 cm



13NE01
Neopolis NE01 Beige Bullnose
3"x12" . 8x30 cm



13NE13
NE13 Moka Bullnose
3"x12" . 8x30 cm



13NE05
Neopolis NE05 Gray Bullnose
3"x12" . 8x30 cm

Stone Effect

Stone Effect



Gotham

12"x24"

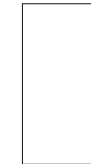

12"x24" . 30x60 cm

Glazed Porcelain Stoneware

ANSI A 137.1 compliant



WALL / FLOOR



RANDOM



0.34 in
8.5 mm



ASTM C 1026
RESISTANT



ASTM C 373
~0.1%



ASTM C 650: CLASS A
ASTM C 1378: CLASS A



ANSI A 326.3:2017 release 2019.
(DCOF): ≥0,42



MEDIUM USE



Gotham
GO10 Bianco



Gotham
GO05 Gray



Gotham
GO01 Beige





Gotham
GO08 Nero

Graphics number

Sizes	Gotham GO10 Bianco	Gotham GO05 Gray	Gotham GO01 Beige	Gotham GO08 Nero
12"x24"	39	42	36	48

Packaging

Sizes	Pieces					
		Sq.Ft.	Lbs.	Boxes	Sq.Ft.	Lbs.
12"x24"	8	15.54	61.40	32	497.28	1965.00
12"x12" mosaic	10	9.70	35.82	-	-	-
12"x12" intreccio	10	9.70	35.82	-	-	-
3"x12" bullnose	20	-	-	-	-	-

Gotham 2

due2 Porcelain Pavers available
in Bianco, Gray, Nero

Gotham

12"x24"

Stone Effect



Stone Effect

Gotham

12"x24"

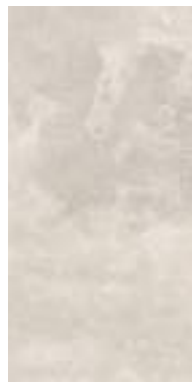

63GO10
Gotham GO10 Bianco
12"x24" . 30x60 cm



63GO05
Gotham GO05 Gray
12"x24" . 30x60 cm



63GO01
Gotham GO01 Beige
12"x24" . 30x60 cm



63GO08
Gotham GO08 Nero
12"x24" . 30x60 cm



32GO10MO
Gotham GO10 Bianco Mosaic*
(sheet 12"x12" . 30x30 cm)



32GO10IN
Gotham GO10 Bianco Intreccio*
(sheet 12"x12" . 30x30 cm)



32GO05MO
Gotham GO05 Gray Mosaic*
(sheet 12"x12" . 30x30 cm)



32GO05IN
Gotham GO05 Gray Intreccio*
(sheet 12"x12" . 30x30 cm)



32GO01MO
Gotham GO01 Beige Mosaic*
(sheet 12"x12" . 30x30 cm)

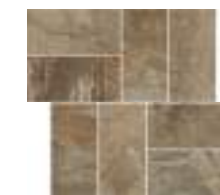

32GO01IN
Gotham GO01 Beige Intreccio*
(sheet 12"x12" . 30x30 cm)



32GO08MO
Gotham GO08 Nero Mosaic*
(sheet 12"x12" . 30x30 cm)



32GO08IN
Gotham GO08 Nero Intreccio*
(sheet 12"x12" . 30x30 cm)



13GO10
Gotham GO10 Bianco Bullnose
3"x12" . 8x30 cm



13GO05
Gotham GO05 Gray Bullnose
3"x12" . 8x30 cm



13GO01
Gotham GO01 Beige Bullnose
3"x12" . 8x30 cm



13GO08
Gotham GO08 Nero Bullnose
3"x12" . 8x30 cm

Stone Effect

Stone Effect

GO

Marble Effect

Nature 130
Clast 156



Nature

24"x48" 24"x24" 12"x24" 4"x12" Rectified Collection

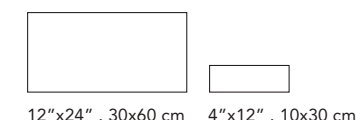
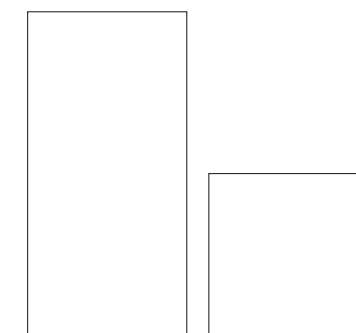

Colored Body Porcelain Stoneware

ANSI A 137.1 compliant

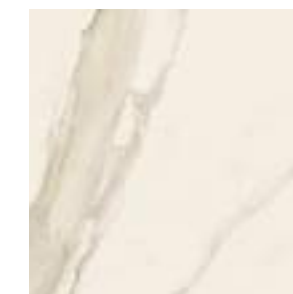
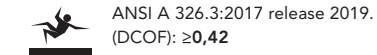

Nature
NA07 Calacatta Gold

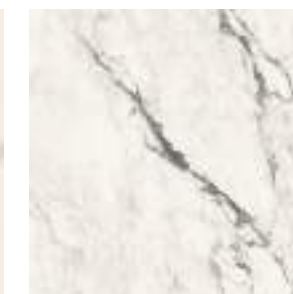

Nature
NA10 Statuario Bianco

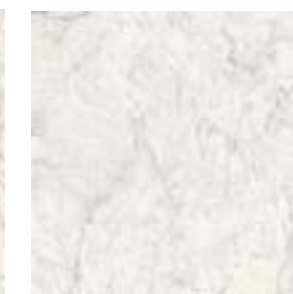

Nature
NA20 Carrara

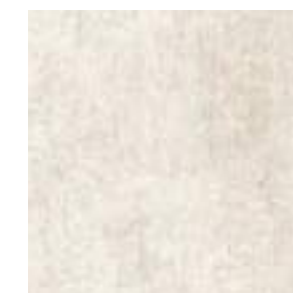

Nature
NA01 Taj Mahal

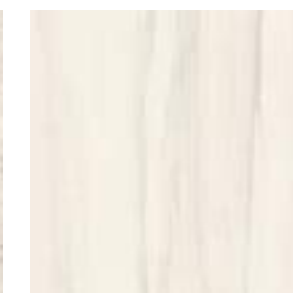

Nature
NA05 Dolomite



Nature
NA25 Calacatta Vagli

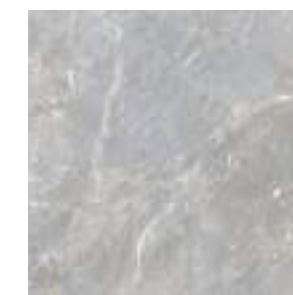

Nature
NA02 Fior di Bosco

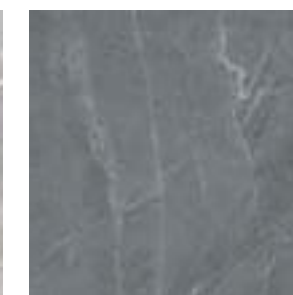

Nature
NA15 Belvedere

Graphics number

Sizes	Nature NA07 Calacatta Gold	Nature NA10 Statuario Bianco	Nature NA20 Carrara	Nature NA01 Taj Mahal	Nature NA05 Dolomite	Nature NA25 Calacatta Vagli	Nature NA02 Fior di Bosco	Nature NA15 Belvedere
24"x48"	14	14	8	10	8	10	10	10
24"x24"	28	28	16	20	16	20	20	20
12"x24"	56	56	32	40	32	40	40	40

Packaging

Sizes	Pieces	Sq.Ft.	Lbs.	Boxes	Sq.Ft.	Lbs.
24"x48"	2	15.50	61.00	36	558.00	2236.00
24"x24"	6	23.25	91.50	24	558.00	2236.00
12"x24"	8	15.50	61.40	32	496.00	1932.48
4"x12"	36	11.65	46,45	40	466.00	1858.00
12"x12" mosaic	10	9.70	-	-	-	-
10"x12" hexagon	10	8.40	-	-	-	-
4"x24" bullnose	10	-	-	-	-	-

Nature 2

due2 Porcelain Pavers available in Carrara, Dolomite

Nature

24"x48" 24"x24" 12"x24" 4"x12"

NA

Marble Effect



Marble Effect

Nature

24"x48" 24"x24" 12"x24" 4"x12"

Marble Effect



Marble Effect

Nature

24"x48" 24"x24" 12"x24" 4"x12"

NA

Marble Effect



Marble Effect

Nature

24"x48" 24"x24" 12"x24" 4"x12"

NA

Marble Effect



Marble Effect

Nature

24"x48" 24"x24" 12"x24" 4"x12"

NA



Marble Effect

Marble Effect

Nature

24"x48" 24"x24" 12"x24" 4"x12"

NA

Marble Effect



142 Wall: Nature NA05 Dolomite 4"x12" | Floor: Nature NA05 Dolomite Rect. 24"x24"



Marble Effect

Floor: Nature NA07 Calacatta Gold Rect. 24"x48" 143

Nature

24"x48" 24"x24" 12"x24" 4"x12"

NA



Marble Effect

Marble Effect

Nature

24"x48" 24"x24" 12"x24" 4"x12"

NA

Marble Effect



146 Floor: Nature NA25 Calacatta Vagli Rect. 24"x24"



Marble Effect

Floor: Nature NA15 Belvedere Rect. 24"x48" 147

Nature

24"x48" 24"x24" 12"x24" 4"x12"

Marble Effect



80NA07R
Nature NA07 Calacatta Gold Rect.
24"x48" . 60x120 cm



30NA07
Nature NA07 Calacatta Gold
4"x12" . 10x30 cm

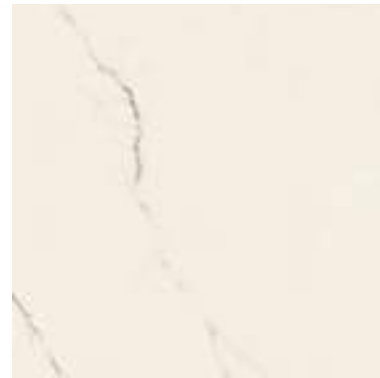

60NA07R
Nature NA07 Calacatta Gold Rect.
24"x24" . 60x60 cm



63NA07R
Nature NA07 Calacatta Gold Rect.
12"x24" . 30x60 cm



32NA07MO
Nature NA07 Calacatta Gold Mosaic*
(sheet 12"x12" . 30x30 cm)



32NA07HEX1
Nature NA07 Calacatta Gold Hexagon*
(sheet 10"x12" . 26x30 cm)



13NA07
Nature NA07 Calacatta Gold Bullnose
4"x24" . 10x60 cm

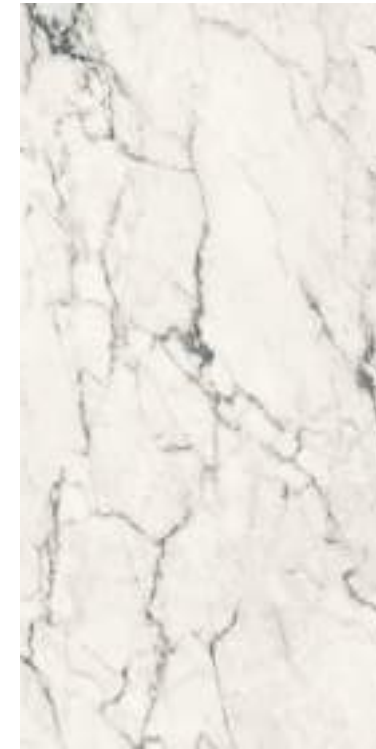

80NA10R
Nature NA10 Statuario Bianco Rect.
24"x48" . 60x120 cm



30NA10
Nature NA10 Statuario Bianco
4"x12" . 10x30 cm

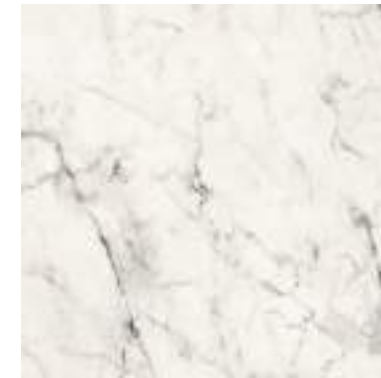

60NA10R
Nature NA10 Statuario Bianco Rect.
24"x24" . 60x60 cm



63NA10R
Nature NA10 Statuario Bianco Rect.
12"x24" . 30x60 cm



32NA10MO
Nature NA10 Statuario Bianco Mosaic*
(sheet 12"x12" . 30x30 cm)



32NA10HEX1
Nature NA10 Statuario Bianco Hexagon*
(sheet 10"x12" . 26x30 cm)



13NA10
Nature NA10 Statuario Bianco Bullnose
4"x24" . 10x60 cm

Marble Effect

Nature

24"x48" 24"x24" 12"x24" 4"x12"

Marble Effect



80NA20R
Nature NA20 Carrara Rect.
24"x48" . 60x120 cm



30NA20
Nature NA20 Carrara
4"x12" . 10x30 cm

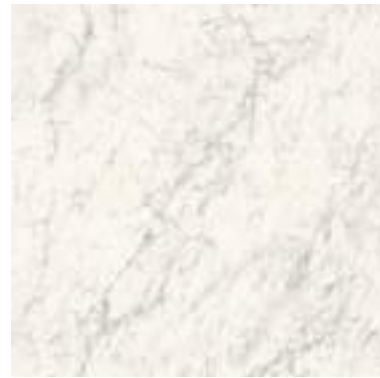

60NA20R
Nature NA20 Carrara Rect.
24"x24" . 60x60 cm

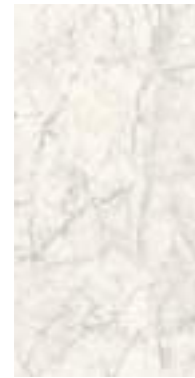

63NA20R
Nature NA20 Carrara Rect.
12"x24" . 30x60 cm

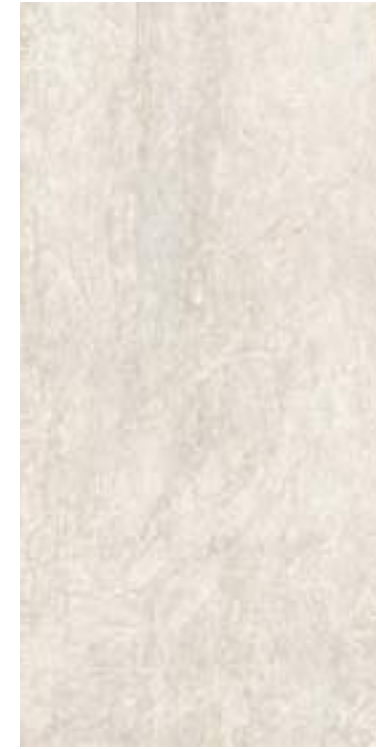

80NA01R
Nature NA01 Taj Mahal Rect.
24"x48" . 60x120 cm



30NA01
Nature NA01 Taj Mahal
4"x12" . 10x30 cm

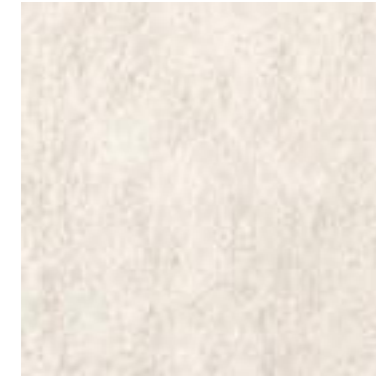

60NA01R
Nature NA01 Taj Mahal Rect.
24"x24" . 60x60 cm



63NA01R
Nature NA01 Taj Mahal Rect.
12"x24" . 30x60 cm



32NA20MO
Nature NA20 Carrara Mosaic*
(sheet 12"x12" . 30x30 cm)



32NA20HEX1
Nature NA20 Carrara Hexagon*
(sheet 10"x12" . 26x30 cm)



13NA20
Nature NA20 Carrara Bullnose
4"x24" . 10x60 cm



32NA01MO
Nature NA01 Taj Mahal Mosaic*
(sheet 12"x12" . 30x30 cm)



32NA01HEX1
Nature NA01 Taj Mahal Hexagon*
(sheet 10"x12" . 26x30 cm)



13NA01
Nature NA01 Taj Mahal Bullnose
4"x24" . 10x60 cm

Marble Effect

Nature

24"x48" 24"x24" 12"x24" 4"x12"

Marble Effect



80NA05R
Nature NA05 Dolomite Rect.
24"x48" . 60x120 cm



30NA05
Nature NA05 Dolomite
4"x12" . 10x30 cm



60NA05R
Nature NA05 Dolomite Rect.
24"x24" . 60x60 cm



63NA05R
Nature NA05 Dolomite Rect.
12"x24" . 30x60 cm



32NA05MO
Nature NA05 Dolomite Mosaic*
(sheet 12"x12" . 30x30 cm)



32NA05HEX1
Nature NA05 Dolomite Hexagon*
(sheet 10"x12" . 26x30 cm)



13NA05
Nature NA05 Dolomite Bullnose
4"x24" . 10x60 cm



80NA25R
Nature NA25 Calacatta Vagli Rect.
24"x48" . 60x120 cm



30NA25
Nature NA25 Calacatta Vagli
4"x12" . 10x30 cm



60NA25R
Nature NA25 Calacatta Vagli Rect.
24"x24" . 60x60 cm



63NA25R
Nature NA25 Calacatta Vagli Rect.
12"x24" . 30x60 cm



32NA25MO
Nature NA25 Calacatta Vagli Mosaic*
(sheet 12"x12" . 30x30 cm)



32NA25HEX1
Nature NA25 Calacatta Vagli Hexagon*
(sheet 10"x12" . 26x30 cm)



13NA25
Nature NA25 Calacatta Vagli Bullnose
4"x24" . 10x60 cm

Marble Effect

NA

Nature

24"x48" 24"x24" 12"x24" 4"x12"

Marble Effect



80NA02R
Nature NA02 Fior di Bosco Rect.
24"x48" . 60x120 cm



30NA02
Nature NA02 Fior di Bosco
4"x12" . 10x30 cm



60NA02R
Nature NA02 Fior di Bosco Rect.
24"x24" . 60x60 cm



63NA02R
Nature NA02 Fior di Bosco Rect.
12"x24" . 30x60 cm



32NA02MO
Nature NA02 Fior di Bosco Mosaic*
(sheet 12"x12" . 30x30 cm)



32NA02HEX1
Nature NA02 Fior di Bosco Hexagon*
(sheet 10"x12" . 26x30 cm)



13NA02
Nature NA02 Fior di Bosco Bullnose
4"x24" . 10x60 cm



80NA15R
Nature NA15 Belvedere Rect.
24"x48" . 60x120 cm



30NA15
Nature NA15 Belvedere
4"x12" . 10x30 cm



60NA15R
Nature NA15 Belvedere Rect.
24"x24" . 60x60 cm



63NA15R
Nature NA15 Belvedere Rect.
12"x24" . 30x60 cm

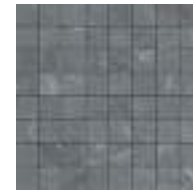

32NA15MO
Nature NA15 Belvedere Mosaic*
(sheet 12"x12" . 30x30 cm)



32NA15HEX1
Nature NA15 Belvedere Hexagon*
(sheet 10"x12" . 26x30 cm)



13NA15
Nature NA15 Belvedere Bullnose
4"x24" . 10x60 cm

Marble Effect



Clast

12"x24" 4"x12"

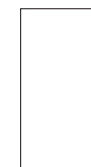

12"x24" . 30x60 cm



4"x12" . 10x30 cm

Glazed Porcelain Stoneware

ANSI A 137.1 compliant



WALL / FLOOR



MODERATE



0.34 in
8.5 mm



ASTM C 1026
RESISTANT



ASTM C 373
~0.1%



ASTM C 650: CLASS A
ASTM C 1378: CLASS A



ANSI A 326.3:2017 release 2019.
(DCOF): ≥0,42



MEDIUM USE



Clast CT01 Beige



Clast CT05 Gray



Clast CT09 Taupe





Clast CT08 Graphite

Graphics number

Sizes	Clast CT01 Beige	Clast CT05 Gray	Clast CT09 Taupe	Clast CT08 Graphite
12"x24"	64	56	72	64

Packaging

Sizes	Pieces					
		Sq.Ft.	Lbs.	Boxes	Sq.Ft.	Lbs.
12"x24"	8	15.54	61.40	32	497.28	1965.00
4"x12"	36	11.65	46.33	40	466.00	1583.00
12"x12" mosaic	10	9.70	35.82	-	-	-
12"x12" brick	10	9.70	35.82	-	-	-
3"x12" bullnose	20	-	-	-	-	-

Clast

12"x24" 4"x12"

CT



Marble Effect

Marble Effect

Clast

12"x24" 4"x12"

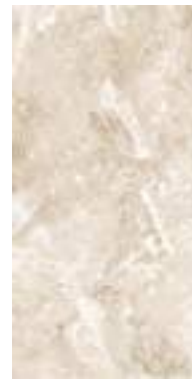

63CT01
Clast CT01 Beige
12"x24" . 30x60 cm



30CT01
Clast CT01 Beige
4"x12" . 10x30 cm



63CT05
Clast CT05 Gray
12"x24" . 30x60 cm



30CT05
Clast CT05 Gray
4"x12" . 10x30 cm



63CT09
Clast CT09 Taupe
12"x24" . 30x60 cm



30CT09
Clast CT09 Taupe
4"x12" . 10x30 cm



63CT08
Clast CT08 Graphite
12"x24" . 30x60 cm



30CT08
Clast CT08 Graphite
4"x12" . 10x30 cm



32CT01MO
Clast CT01 Beige Mosaic*
(sheet 12"x12" . 30x30 cm)



32CT01BR
Clast CT01 Beige Brick*
(sheet 12"x12" . 30x30 cm)



32CT05MO
Clast CT05 Gray Mosaic*
(sheet 12"x12" . 30x30 cm)



32CT05BR
Clast CT05 Gray Brick*
(sheet 12"x12" . 30x30 cm)



32CT09MO
Clast CT09 Taupe Mosaic*
(sheet 12"x12" . 30x30 cm)



32CT09BR
Clast CT09 Taupe Brick*
(sheet 12"x12" . 30x30 cm)

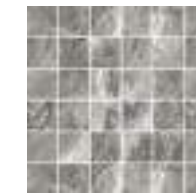

32CT08MO
Clast CT08 Graphite Mosaic*
(sheet 12"x12" . 30x30 cm)



32CT08BR
Clast CT08 Graphite Brick*
(sheet 12"x12" . 30x30 cm)



13CT01
Clast CT01 Beige Bullnose
3"x12" . 8x30 cm



13CT05
Clast CT05 Gray Bullnose
3"x12" . 8x30 cm



13CT09
Clast CT09 Taupe Bullnose
3"x12" . 8x30 cm



13CT08
Clast CT08 Graphite Bullnose
3"x12" . 8x30 cm

Marble Effect

Marble Effect

Concrete Effect

Essential 164



Concrete Effect

Essential

24"x48" 24"x24" 12"x24" 4"x12" Rectified Collection

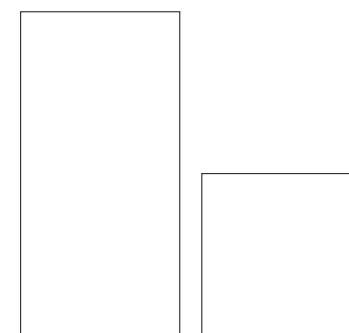

24"x48" . 60x120 cm 24"x24" . 60x60 cm



12"x24" . 30x60 cm 4"x12" . 10x30 cm

Colored Body Porcelain Stoneware

ANSI A 137.1 compliant

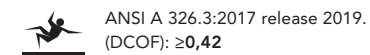

Essential
HET10 White



Essential
HET05 Gray



Essential
HET08 Graphite

Graphics number

Sizes	Essential HET 10 White	Essential HET 05 Gray	Essential HET 08 Graphite
24"x48"	10	10	10
24"x24"	20	20	20
12"x24"	40	40	40

Packaging

Sizes	Pieces					
		Sq.Ft.	Lbs.	Boxes	Sq.Ft.	Lbs.
24"x48"	2	15.50	61.00	36	558.00	2236.00
24"x24"	6	23.25	91.50	24	558.00	2236.00
12"x24"	8	15.50	61.40	32	496.00	1932.48
4"x12"	36	11.65	46,45	40	466.00	1858.00
12"x24" essential design	8	15.50	61.40	32	496.00	1932.48
12"x12" mosaic	10	9.70	-	-	-	-
12"x12" card mosaic	10	9.70	-	-	-	-
4"x24" bullnose	10	-	-	-	-	-

Essential 2

due2 Porcelain Pavers available

Concrete Effect

Essential

24"x48" 24"x24" 12"x24" 4"x12"

HET

Concrete Effect



Concrete Effect



Wall: Essential HET08 Graphite Rect. 12"x24" - Essential Design Rect. 12"x24"
Woodland HWL03 Nature Rect. 8"x48"

Essential

24"x48" 24"x24" 12"x24" 4"x12"



G8ET10R
Essential HET10 White Rect.
12"x24" . 30x60 cm

G0ET10
Essential HET10 White
4"x12" . 10x30 cm

GCET10R
Essential HET10 White Rect.
24"x48" . 60x120 cm

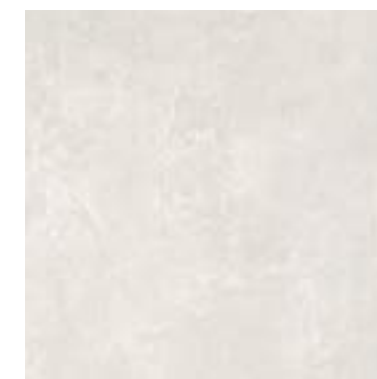

G9ET10R
Essential HET10 White Rect.
24"x24" . 60x60 cm



G8ETDESIGNR
Essential Design Rect.
12"x24" . 30x60 cm

The Design decoration can be used in both wall and floor tiles, and also in combination with the Woodland series.



G3ET10MO
Essential HET10 White Mosaic*
(sheet 12"x12" . 30x30 cm)



G3ET10MOC
Essential HET10 White Card Mosaic*
(sheet 12"x12" . 30x30 cm)



G0ET10
Essential HET10 White Bullnose
4"x24" . 10x60 cm

Essential

24"x48" 24"x24" 12"x24" 4"x12"

Concrete Effect



GCET05R
Essential HET05 Gray Rect.
24"x48" . 60x120 cm



G8ET05R
Essential HET05 Gray Rect.
12"x24" . 30x60 cm



G9ET05R
Essential HET05 Gray Rect.
24"x24" . 60x60 cm



30ET05
Essential HET05 Gray
4"x12" . 10x30 cm



G8ETDESIGNR
Essential Design Rect.
12"x24" . 30x60 cm

The Design decoration can be used in both wall and floor tiles, and also in combination with the Woodland series.

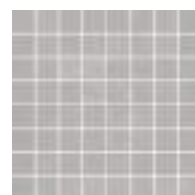

G3ET05MO
Essential HET05 Gray Mosaic*
(sheet 12"x12" . 30x30 cm)



G3ET05MOC
Essential HET05 Gray Card Mosaic*
(sheet 12"x12" . 30x30 cm)



G0ET05
Essential HET05 Gray Bullnose
4"x24" . 10x60 cm



GCET08R
Essential HET08 Graphite Rect.
24"x48" . 60x120 cm



G8ET08R
Essential HET08 Graphite Rect.
12"x24" . 30x60 cm



G9ET08R
Essential HET08 Graphite Rect.
24"x24" . 60x60 cm



30ET08
Essential HET08 Graphite
4"x12" . 10x30 cm



G8ETDESIGNR
Essential Design Rect.
12"x24" . 30x60 cm

The Design decoration can be used in both wall and floor tiles, and also in combination with the Woodland series.



G3ET08MO
Essential HET08 Graphite Mosaic*
(sheet 12"x12" . 30x30 cm)



G3ET08MOC
Essential HET08 Graphite Card Mosaic*
(sheet 12"x12" . 30x30 cm)



G0ET08
Essential HET08 Graphite Bullnose
4"x24" . 10x60 cm

HET

Concrete Effect

Brick Effect

Kensington	174
Cantina	180

Kensington

3"x16"



3"x16" . 7,5x40 cm

Glazed Porcelain Stoneware

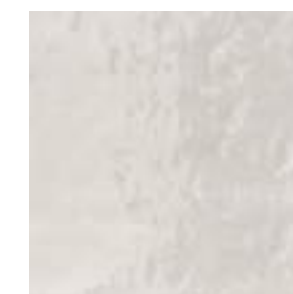

Kensington
KT10 Bianco

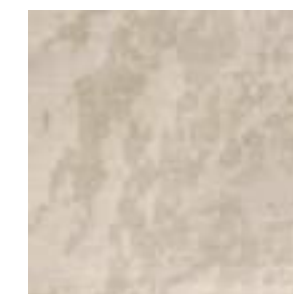

Kensington
KT01 Beige



Kensington
KT08 Nero

ANSI A 137.1 compliant

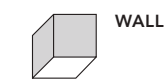

WALL



MODERATE



0.34 in
8.5 mm



ASTM C 1026
RESISTANT



ASTM C 373
~0.1%





ASTM C 650: CLASS A
ASTM C 1378: CLASS A

Made in San Marino

Graphics number

Sizes	Kensington KT10 Bianco	Kensington KT01 Beige	Kensington KT08 Nero
3"x16"	48	48	48

Packaging

Sizes	Pieces					
		Sq.Ft.	Lbs.	Boxes	Sq.Ft.	Lbs.
3"x16"	44	14.21	54.19	36	511.50	1995.20



Kensington

3"x16"

KT

Brick Effect



Brick Effect



Wall: Kensington KT10 Bianco 3"x16"

Kensington

3"x16"



74KT10
Kensington KT10 Bianco
3"x16" . 7,5x40 cm



74KT01
Kensington KT01 Beige
3"x16" . 7,5x40 cm



74KT08
Kensington KT08 Nero
3"x16" . 7,5x40 cm



Cantina

4"x12"



4"x12" . 10x30 cm

Glazed Porcelain Stoneware



Cantina
CA10 Bianco



Cantina
CA06 Rosso



Cantina
CA08 Nero

ANSI A 137.1 compliant



WALL / FLOOR



RANDOM



0.34 in
8.5 mm



ASTM C 1026
RESISTANT



ASTM C 373
~0.1%



ASTM C 650: CLASS A
ASTM C 1378: CLASS A



ANSI A 326.3:2017 release 2019.
(DCOF): ≥0,42





HEAVY USE

Made in San Marino

Graphics number

Sizes	Cantina CA10 Bianco	Cantina CA06 Rosso	Cantina CA08 Nero
4"x12"	53	72	64

Packaging

Sizes	Pieces				
		Sq.Ft.	Lbs.	Sq.Ft.	Lbs.
4"x12"	32	10.34	37.10	60	620.00 2226.00

Cantina

4"x12"

CA

Brick Effect



Brick Effect



Wall: Cantina CA08 Nero 4"x12"

Cantina

4"x12"



30CA10J
Cantina CA10 Bianco
4"x12" . 10x30 cm



30CA06J
Cantina CA06 Rosso
4"x12" . 10x30 cm



30CA08J
Cantina CA08 Nero
4"x12" . 10x30 cm

Decorative Effect

Fragrance 188
Havana 196

Fragrance

8"x8" 3"x16"



8"x8" . 20x20 cm

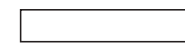

3"x16" . 7,5x40 cm

Glazed Porcelain Stoneware

ANSI A 137.1 compliant



8"x8": WALL / FLOOR



3"x16": WALL



MODERATE



0.34 in
8.5 mm



ASTM C 1026
RESISTANT



ASTM C 373
~0.1%



ASTM C 650: CLASS A
ASTM C 1378: CLASS A



ANSI A 326.3:2017 release 2019.
(DCOF): ≥0,42



MEDIUM USE (8"x8")

Made in San Marino



Fragrance
FR10 Bianco



Fragrance
FR08 Nero

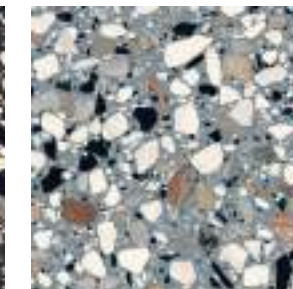

Fragrance
FR02 Azzurro



Fragrance
FR10 Bianco



Fragrance
FR04 Verde Acqua



Fragrance
FR05 Grigio



Fragrance
FR02 Azzurro

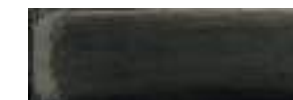

Fragrance
FR08 Nero



Fragrance
FR12 Blu Notte

Graphics number

Sizes	Fragrance FR10 Bianco	Fragrance FR02 Azzurro	Fragrance FR08 Nero	Fragrance FR04 Verde Acqua	Fragrance FR05 Grigio	Fragrance FR12 Blu Notte
8"x8"	25	25	25			
3"x16"	12	13	12	12	12	12

Packaging

Sizes	8"x8"			3"x16"		
	Pieces	Sq.Ft.	Lbs.	Boxes	Sq.Ft.	Lbs.
8"x8"	29	12.49	48.78	45	561.87	2240.00
3"x16"	44	14.21	54.19	36	511.50	1995.20

Wall: Fragrance FR 4 / Verde Acqua Brick 3"x16"
Fragrance FR 10 / Bianco Macro 8"x8"
Floor: Fragrance FR 10 / Bianco Macro 8"x8"

Fragrance

8"x8" 3"x16"

FR

Decorative Effect



Decorative Effect

Fragrance

8"x8" 3"x16"

FR

Decorative Effect



192 Wall: Fragrance FR12 Blu Notte Brick 3"x16"



Decorative Effect

193 Wall: Fragrance FR02 Azzurro Macro 8"x8"

Fragrance

8"x8" 3"x16"

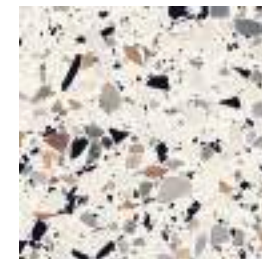

20FR10MA
Fragrance FR10 Bianco Macro
8"x8" . 20x20 cm



20FR08MA
Fragrance FR08 Nero Macro
8"x8" . 20x20 cm



20FR02MA
Fragrance FR02 Azzurro Macro
8"x8" . 20x20 cm



74FR10
Fragrance FR10 Bianco Brick
3"x16" . 7,5x40 cm



74FR04
Fragrance FR04 Verde Acqua Brick
3"x16" . 7,5x40 cm



74FR05
Fragrance FR05 Grigio Brick
3"x16" . 7,5x40 cm



74FR02
Fragrance FR02 Azzurro Brick
3"x16" . 7,5x40 cm



74FR08
Fragrance FR08 Nero Brick
3"x16" . 7,5x40 cm



74FR12
Fragrance FR12 Blu Notte Brick
3"x16" . 7,5x40 cm

Havana

8"x8"



8"x8" - 20x20 cm

Glazed Porcelain Stoneware

ANSI A 137.1 compliant



8"x8": WALL / FLOOR



MODERATE



0.34 in
8.5 mm



ASTM C 1026
RESISTANT



ASTM C 373
~0.1%



ASTM C 650: CLASS A
ASTM C 1378: CLASS A



ANSI A 326.3:2017 release 2019.
(DCOF): ≥0,42



MEDIUM USE

Made in San Marino



Havana Gables



Havana Key West



Havana Brickell



Havana Banyan

Graphics number

Sizes	Havana Gables	Havana Key West	Havana Brickell	Havana Banyan
8"x8"	1	1	1	1

Packaging

Sizes	Pieces	Sq.Ft.	Lbs.	Boxes	Sq.Ft.	Lbs.
8"x8"	29	12.49	48.78	45	561.87	2240.00

Havana

8"x8"

Decorative Effect



Decorative Effect





Havana

8"x8"



20AA00GAA
Havana Gables
8"x8" . 20x20 cm



20AA00KEA
Havana Key West
8"x8" . 20x20 cm



20AA00BRA
Havana Brickell
8"x8" . 20x20 cm



20AA00BAA
Havana Banyan
8"x8" . 20x20 cm



HAVANA GABLES
Sample layout 4x4 tiles



HAVANA KEY WEST
Sample layout 4x4 tiles

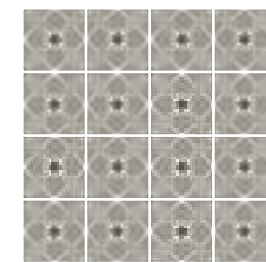

HAVANA BRICKELL
Sample layout 4x4 tiles

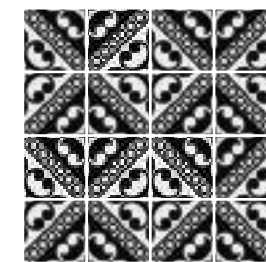

HAVANA BANYAN
Sample layout 4x4 tiles

Technical characteristics

TECHNICAL CHARACTERISTICS AND STANDARDS OF REFERENCE

Our first choice porcelain tiles are compliant with ISO 13006 & ANSI A137.1 standard.

Therefore they must not be perfect (which is impossible for any industrial product) but fall within the tolerances defined by the standard.

The valuation of the appearance of the tiles shall be performed, as defined by the standard, placing tiles on a viewing board and examining it (perpendicularly) from a distance of at least 1 meter (3.3 feet).

Defects of tiles can be of two types: noticeable (already visible before setting, such as color differences, surface defects, fractures, etc) or hidden (not visible before setting). Claims about noticeable defects may be made only before tiles are installed, allowing the manufacturer to replace any defective material. However, if the buyer or tile installer decides to proceed with installation, the responsibility of the manufacturer is invalidated. No claims will be accepted regarding installed product.

Responsibility for hidden defects remains with the producer if these are notified within the legal time limits.

Catalogs indicate nominal size, not actual size.







RECOMMENDATIONS FOR USE

No laboratory test, however efficient it may be, is sufficient to determine the durability of a product. Apart from the obvious factor of the number of foot contacts, durability can also be influenced by the technical characteristics of the product, location of the installation and the possible presence of abrasive agents. We therefore recommend not only that products should be chosen with resistance characteristics that are sufficient for the intended use, as shown in the following chart, but also that floors should be protected against sand, grit and other abrasives with the use, for example, of mats.

See www.delconcausa.com/download/edpceramictile.pdf to download the EPD report covering Del Conca USA products.

ANSI A 137.1

Colored Body Porcelain Stoneware Glazed Porcelain Stoneware

	Established limits	Performances	Norms
 Water absorption	≤ 0,5%	~ 0,1%	ASTM C 373
 Breaking strength (1)	≥ 250 lbf.	Conforms	ASTM C 648
 Resistance to freeze-thaw cycling	Resistant	Frost proof	ASTM C 1026
 Resistance to thermal shock	Resistant	Resistant	ASTM C 484
 Slip resistance (DCOF)	≥ 0,42	Only for Natural Surface Conforms	ANSI A 326.3:2019 release 2019. (DCOF)
 Chemical resistance	As reported	Class: A	ASTM C 650
 Stain resistance	As reported	Class: A	ASTM C 1378

Reference values valid for almost all our collections. Browse through our website for further specifications.

(1) It states the resistance of a sample piece, leaning on three spots, to a concentrated load placed in the middle.

Key to symbols

SHADE VARIATIONS

 **LOW**
Uniform colour with only minimal differences between tiles in the same production run.

 **MODERATE**
Clearly distinguishable differences in texture and pattern within the same production run.

 **HIGH**
Significant variation in texture, pattern and colour from tile to tile within the same production run. The colour range should be viewed before selecting the material.

 **RANDOM**
Random differences from tile to tile. One tile may have totally different texture and colour from another. The colour range should be viewed before selecting the material.

RECOMMENDED USE

 Recommended for floors for medium-light use, as in private homes, with the exception of kitchens and rooms with direct outdoor access.

 Recommended for all rooms in the house and for business premises with medium use.

 Recommended for all rooms indoors and outdoors and for business premises in general.

Layouts

1. Fragrance (3"x16" . 7,5x40 cm)

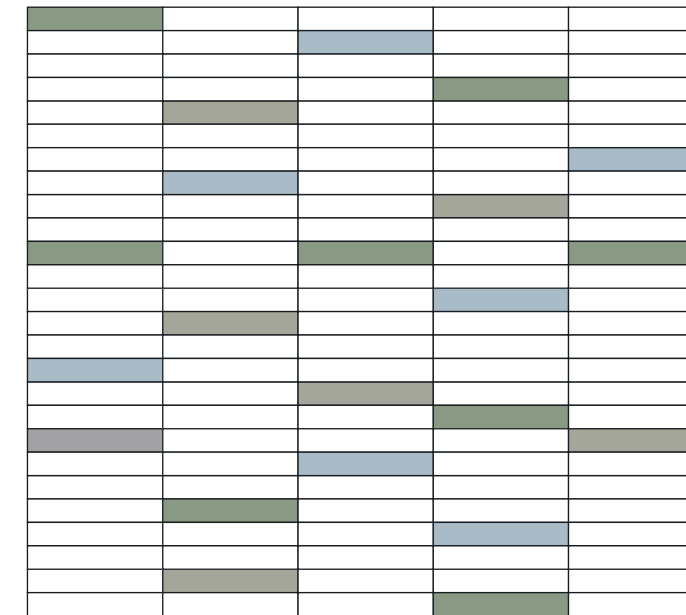

PRODUCTS	PERCENTAGES	PIECES
FR10 Bianco Brick	83.08%	108
FR04 Verde Acqua Brick	6.15%	8
FR05 Grigio Brick	5.38%	7
FR02 Azzurro Brick	5.38%	7

3

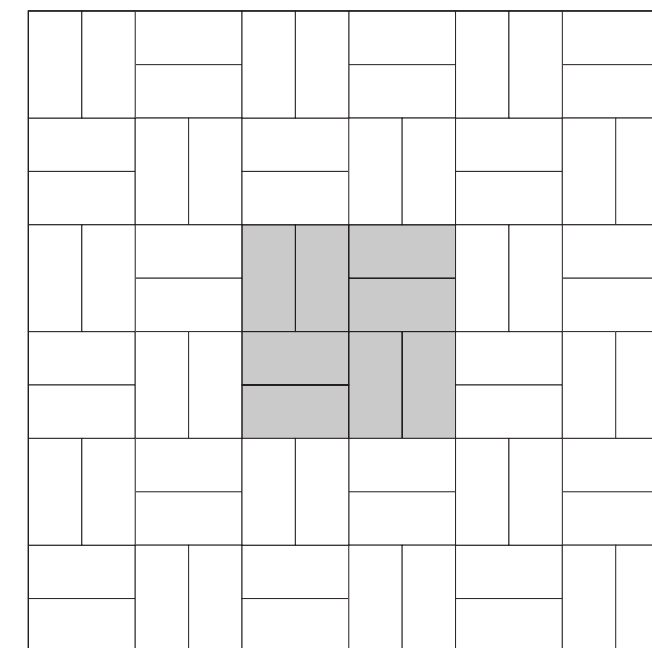

FORMATS	%	PIECES/SQ.FT
24"x48"	100%	0.129

2. Fragrance (3"x16" . 7,5x40 cm)



PRODUCTS	PERCENTAGES	PIECES
FR10 Bianco Brick	44.29%	62
FR04 Verde Acqua Brick	50%	70
FR12 Blu Notte Brick	5.71%	8

4

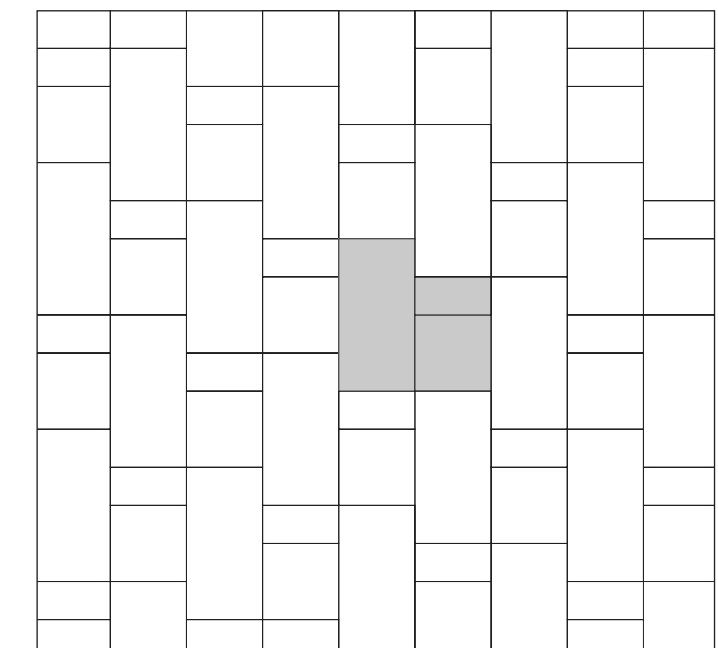

FORMATS	%	PIECES/SQ.FT
24"x48"	57.14%	0.0700
24"x24"	28.57%	0.0700
12"x24"	14.29%	0.0700

Match shades before installation

Mosaics and Muretto sizes

Mosaic

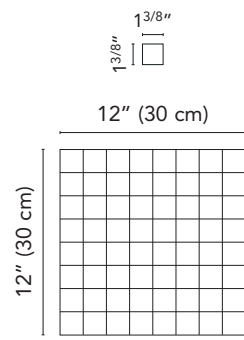

Available on series:

New England
Quartzite
Navona
Chamonix
Nature
Essential

Mosaic

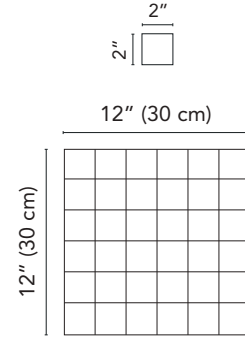

Available on series:

Verona
Woodscape
Neopolis
Gotham
Clast

Mosaic

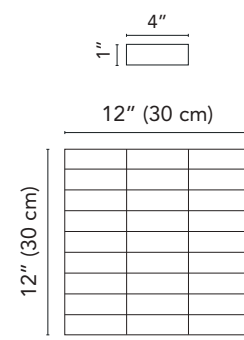

Available on series:

West 57th

Card Mosaic

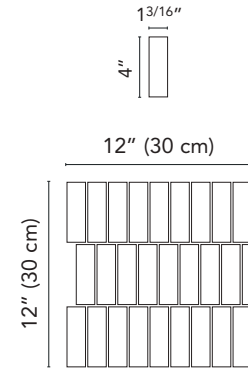

Available on series:

Essential

Brick

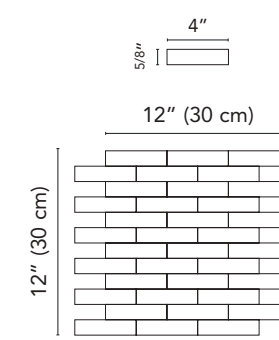

Available on series:

Clast

Brick

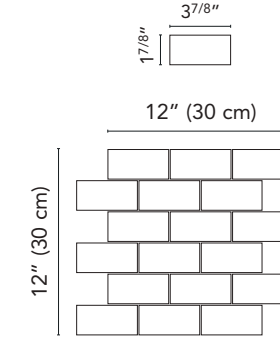

Available on series:

New England

Muretto Wall

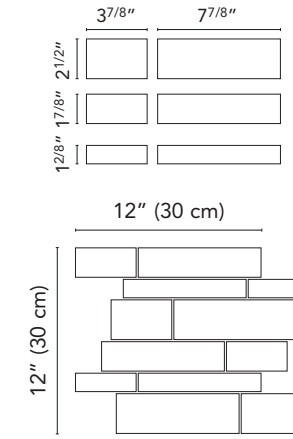

Available on series:

Quartzite
Navona

Herringbone Mosaic

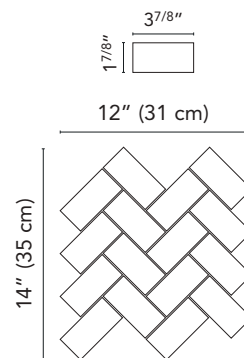

Available on series:

New England

Capri Mosaic

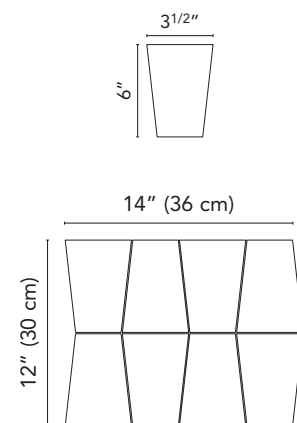

Available on series:

Neopolis

Hexagon

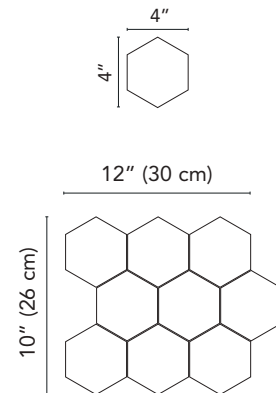

Available on series:

Chamonix
Nature

Intreccio

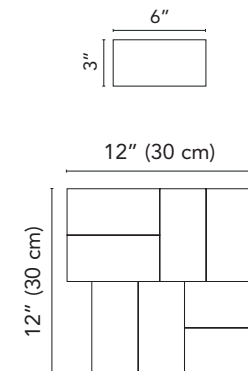

Available on series:

Gotham

Muretto Brick

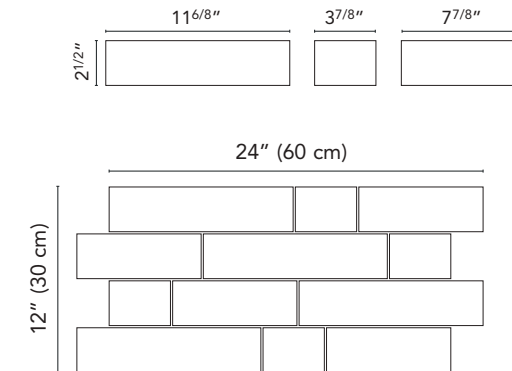

Available on series:

Chamonix

Muretto

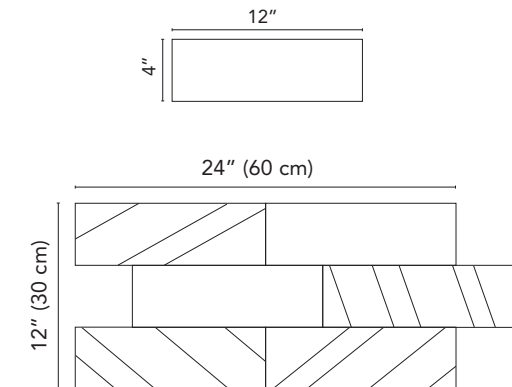

Available on series:

West 57th

Terms and conditions of sale

1. These Terms and Conditions of Sale shall apply to all orders and contracts entered into by Del Conca USA, Inc. (the "Seller" or "Del Conca") and the Purchaser for the sale of products manufactured or distributed by Del Conca USA (the "Products") unless Seller otherwise specifically agrees in writing. By placing any order for Products, the Purchaser agrees to these Terms and Conditions of Sale. Any other terms or conditions which may at any time be indicated by the Purchaser, in the Purchaser's order form or otherwise (whether oral, typed, written or printed) shall be null and void and of no effect, even if not expressly objected to by the Seller.

2. All prices are stated in U.S. Dollars per square foot or per piece unless otherwise noted.

3. Prices are for first choice material only.

4. Full Truckload (FTL) prices are applied only to orders for shipment of at least 43,000 pounds (including pallet weight) from the Loudon, TN factory and comprised exclusively of materials stored at that specific facility.

5. All pricing is calculated FOB Factory (Loudon, TN), excluding transportation and shipping charges, taxes, fees and custom duties.

6. The Purchaser shall make all payments pursuant to the invoices issued by the Seller, notwithstanding any claim for any alleged defect, fault or irregularity in the Products. Unless otherwise specifically agreed by the Seller in writing, payment by the Purchaser is due upon receipt of Seller's invoice. Invoice for FTL shall be payable within 30 days from the issuance of the invoice. In the event of any delay in payment, the Seller shall have the right to suspend deliveries and may, at its option (i) require immediate payment of all or any part of any and all sums owed by the Purchaser, irrespective of any credit terms previously agreed to, and (ii) terminate the Contract (as well as any and all other contracts with the Purchaser) in whole or in part, and hold the Purchaser liable for damages. In addition, in the event the Seller does not receive full payment by the due date, the Purchaser shall pay to the Seller interest on the unpaid amount, from the due date to the date payment is actually received by the Seller, at the monthly rate of interest of one and one half percent (1 ½%), but not to exceed the highest amount allowed by law. Seller's right to such interest shall be in addition to, and not in lieu of, all other rights and remedies arising by reason of such nonpayment. Any payment received by the Seller may be applied to any outstanding balance owed by the Purchaser to the Seller, as the Seller, in its sole discretion, may determine, any instructions of the Purchaser to the contrary notwithstanding.

7. Del Conca USA reserves the right to apply a surcharge on orders comprising non-full pallets.

8. All orders are subject to availability. No order of the Purchaser will be binding upon Del Conca USA unless accepted by Del Conca USA on Del Conca USA's form of Order Confirmation, signed by an officer or employee of Del Conca USA duly authorized to sign on behalf of Del Conca USA, and then only as and to the extent set forth in such Order Confirmation. Del Conca USA reserves the right to reject any order in whole or in part. Any term, condition or provision set forth in Seller's Order Confirmation which is not objected to by the Purchaser in writing within ten days after the date thereof will conclusively be deemed to have been accepted by the Purchaser. Every order of the Purchaser will be binding on the Purchaser unless and until it is rejected in writing by the Seller, and may not be cancelled, withdrawn or modified by the Purchaser; however, in the event of a partial acceptance by the Seller, the Purchaser will no longer be bound with respect to the parts of the order not accepted by the Seller.

9. Purchaser will take delivery of the Products at the Seller's premises ("ex factory"). Unless otherwise specifically agreed by Seller in writing: (i) all risk of loss or damage to the Products shall pass to the Purchaser upon delivery of the Products by the Seller to a carrier; (ii) the Seller shall not be required to procure insurance to cover the Products during transportation in shipment; (iii) any shipping arrangements made by the Seller with carriers or forwarding agents at the Purchaser's request shall be made solely on the Purchaser's behalf and at the Purchaser's sole cost and risk; (iv) any agent appointed for such shipment shall be solely the Purchaser's agent for all purposes; (v) the Purchaser shall be responsible for all the unloading and receipt of the Products at its destination; and (vi) any claim for loss or damage shall be made by the Purchaser solely against the carrier.

10. Any delivery dates specified by the Seller will be deemed to be estimates only, unless specific commitments are made in writing by the Seller. In no event is the time of delivery of the Products of the essence. The Seller reserves the right to cancel, in whole or in part, or to suspend or delay, in whole or in part, any orders due to (i) shortages of, or failures of Seller's suppliers to deliver, or delays of Seller's suppliers in delivering materials, (ii) work stoppages or other labor troubles, (iii) acts of God or (iv) any event in the nature of force majeure or beyond Seller's control. Delivery dates will be extended by the amount of any additional time required by the Seller to make delivery as a result of any such condition or event. The Seller also reserves the right to discontinue particular Products or lines of Products, or to substitute other Products or lines, in response to production and market requirements and demands. The Purchaser waives any and all claims and rights which the Purchaser might otherwise have arising out of or in connection with or relating to any delay in delivery of the Products for any reason whatsoever or any failure of the Seller to deliver by reason of the exercise by the Seller of any of its rights pursuant to these Terms and Conditions of Sale, including, without limitation, any and all claims for or rights to direct, indirect, incidental, consequential or other damages or compensation, and any and all rights to terminate or cancel the order, in whole or in part.

11. Product representations made in photographs, catalogs, advertisement, sampling and online formats as well as in any other publications are indicative of the product only. Variations in color finish and size can occur and the Seller does not warrant the uniformity of color, tone or shade of the Products or the conformity of the Products to the color, tone or shade of any sample. It is Purchaser's responsibility to verify the suitability of the material before installation.

12. Any Product return shall be previously authorized by Del Conca USA and returned products must be accompanied by an approved Return Authorization form and is subject to a 25% handling charge. Freight for the return is the responsibility of the Purchaser.

13. Limited Warranty / Product Claims: Del Conca USA warrants that its first choice, domestically produced ceramic tile is manufactured according to ANSI A137.1 and meets or exceeds these requirements. If a first choice tile purchased by the Purchaser pursuant to these Terms and Conditions of Sale is proven to contain a manufacturing defect, Del Conca USA will supply, free of charge, material of compatible color and shade, as determined by Del Conca USA. **Labor charges are expressly excluded from this warranty.** The Purchaser waives any and all other claims and rights which the Purchaser might otherwise have arising out of or in connection with or relating to any breach of warranty or arising out of or in connection with or relating to any defect, fault or irregularity in the Products, including, without limitation, any and all claims for or rights to direct, indirect, incidental, consequential or other compensation or damages, and any and all rights to terminate or cancel the order, in whole or in part.

14. Del Conca USA makes no warranty as to the suitability of its tile for a particular installation. Del Conca USA does not warrant that its glazed or unglazed tile will not scratch, chip, or show signs of wear.

15. Del Conca USA must be notified by the Purchaser of any claims or defects as soon as reasonably possible, but in any case not later than six months after the Products have been delivered by Del Conca USA. Any claim of the Purchaser of any and every kind must be in writing and sent by certified mail, return receipt requested. Failure to make any claim in such manner or within such six month period shall constitute an irrevocable acceptance of the Products.

16. Claims concerning shade, appearance, caliber, finish or obvious defects in first choice production must be communicated before the tile is installed. No claims will be accepted for tile already installed or for defects in other than first choice material.

17. Del Conca USA specifically excludes liability for consequential or incidental damages except where exclusion of consequential damage is not permitted by state law.

18. This limited warranty shall constitute the full extent of Del Conca USA's liability and is in place of all other warranties or representations, express or implied, including, without limitation, any warranty of merchantability or fitness for a particular purpose.

19. Until the Seller collects in full all amounts required to be paid by the Purchaser for the Products, as well as any and all other amounts owed by the Purchaser to the Seller, the Seller retains title to the Products, and shall have a first and senior purchase money security interest in, an lien on, the Products and all proceeds thereof, under the Uniform Commercial Code as in effect in the United States, to secure the payment of all such amounts. By placing an order with the Seller, the Purchaser authorizes the Seller to file any and all financing statements with respect to such security interest which Seller may deem necessary or desirable. The Purchaser shall, at the request of the Seller, execute any and all financing statements and other documents which the Seller may request to perfect or evidence such title and such security interest.

20. In the event the Seller retains a collection agency to collect any amount owed by the Purchaser, or institutes proceedings to collect such amount or to enforce any right against the Purchaser, including enforcement of any security interest granted to the Seller, the Purchaser shall reimburse the Seller for all collection agency fees and costs, or all costs incurred in such legal proceedings, including reasonable attorneys' fees.

21. The Parties agree that the laws of the State of Tennessee (without giving effect to principles of conflicts of law), to the exclusion of the laws of any other state, shall be applicable to all orders or contracts entered into pursuant to this Terms and Conditions of Sale, their construction, interpretation, effect, performance or non-performance or the consequences thereof. For all disputes or controversies which may arise between the Parties out of or in connection with all orders or contracts entered into pursuant to this Terms and Conditions of Sale, their construction, interpretation, effect, performance or non-performance or the consequences thereof, the Parties hereby consent to the jurisdiction of the courts in the State of Tennessee, and agrees that such courts, to the exclusion of all other courts, shall have exclusive jurisdiction with respect to any and all such disputes and controversies.



Tile Council of North America (TCNA)

TCNA is the trade association representing manufacturers of ceramic tile, tile installation materials, tile equipment, raw materials, and other tile-related products of North America.

For further information, please visit www.delconcausa.com

The company reserves the right to make any change to products and features shown in this catalogue.
All colors are purely representative.

Any kind of copy of this catalogue, even partial reproduction, is prohibited.

© 2023 Del Conca USA, Inc. All rights reserved.

JANUARY / 2023