



# Index

6	History
8	Where we are
10	About Del Conca USA
12	Product Effect
14	Technology
16	Our Team
18	Social Responsibility
20	Sustainability
22	User's Guide
26	Wood Effect
70	Stone Effect
162	Marble Effect
206	Concrete Effect
220	Brick Effect
236	Decorative Effect
246	Technical Characteristics
247	Layouts
248	Mosaics and Muretto sizes
250	Terms and conditions of sale

# Alphabetical Index

- 64 Barton Creek
- 230 Cantina
- 130 Chamonix
- 86 Endless
- 208 Essential
- 238 Fragrance
- 156 Gotham
- 48 Hardin Valley
- 72 Horizons
- 222 Kensington
- 58 Lumber
- 164 Nature
- 122 Navona
- 150 Neopolis
- 94 New England
- 114 Quartzite
- 106 Verona
- 54 Voyage
- 140 West 57th
- 28 Woodchic
- 36 Woodland
- 42 Woodscape

# Index by Effect



## Wood Effect

- 28 Woodchic
- 36 Woodland
- 42 Woodscape
- 48 Hardin Valley
- 54 Voyage
- 58 Lumber
- 64 Barton Creek



## Stone Effect

- 72 Horizons
- 86 Endless
- 94 New England
- 106 Verona
- 114 Quartzite
- 122 Navona
- 130 Chamonix
- 140 West 57th
- 150 Neopolis
- 156 Gotham

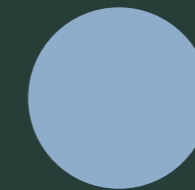

## Marble Effect

- 164 Nature



## Concrete Effect

- 208 Essential

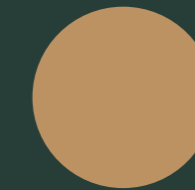

## Brick Effect

- 222 Kensington
- 230 Cantina

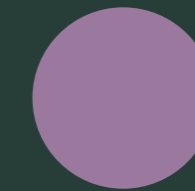

## Decorative Effect

- 238 Fragrance

# Index by Size

## 24x48 in

72 Horizons  
94 New England  
164 Nature  
114 Quartzite  
122 Navona  
208 Essential  
130 Chamonix

## 12x48 in

114 Quartzite  
122 Navona

## 8x48 in

28 Woodchic  
36 Woodland  
48 Hardin Valley  
42 Woodscape

## 8x32 in

28 Woodchic  
64 Barton Creek  
54 Voyage

## 24x24 in

72 Horizons  
94 New England  
164 Nature  
196 Essential  
130 Chamonix

## 12x24 in

72 Horizons  
86 Endless  
94 New England  
106 Verona  
164 Nature  
208 Essential  
122 Navona  
114 Quartzite  
130 Chamonix  
156 Gotham  
150 Neopolis  
140 West 57th

## 6x24 in

58 Lumber  
54 Voyage

## 3x16 in

238 Fragrance  
222 Kensington

## 4x12 in

72 Horizons  
94 New England  
164 Nature  
208 Essential  
122 Navona  
114 Quartzite  
230 Cantina  
150 Neopolis

## 8x8 in

238 Fragrance



# History

1962

CERAMICA FAETANO  
FAETANO (SAN MARINO)



Faetano has produced hand made ceramics for decades, and today its designs carry this heritage embedded in their looks and colors.

1979

CERAMICA DEL CONCA  
SAN CLEMENTE (ITALY)



Ceramica Del Conca sets the foundation of the Del Conca Group. The company boasts a conspicuous sensibility for technological innovation, design, quality, research and the environment: testaments to a savvy ceramic culture.

2000/2017

CERAMICA DEL CONCA  
SAN CLEMENTE (ITALY)  
SAVIGNANO (ITALY)



Ceramica del Conca undergoes a period of remarkable industrial expansion, with new production plants and upgrades for the production of high-value and extra thick tiles and porcelain slabs.

2014

DEL CONCA USA  
LOUDON, TN



Del Conca USA is established in Loudon, TN to combine local production and Italian design, providing creativity, research and technological innovation to better serve North American customers.

# Where we are

Del Conca USA is the USA subsidiary of the Del Conca Group. With four factories located in Italy, San Marino and the USA, the Group has a product portfolio containing floor and wall, indoor and outdoor, pavers and porcelain slabs.

Del Conca USA's products are designed in Italy with an eye for North American taste and made in the USA for maximum convenience. The best collections by Del Conca and Faetano are stocked in Loudon, TN, offering additional products from the Del Conca Group.

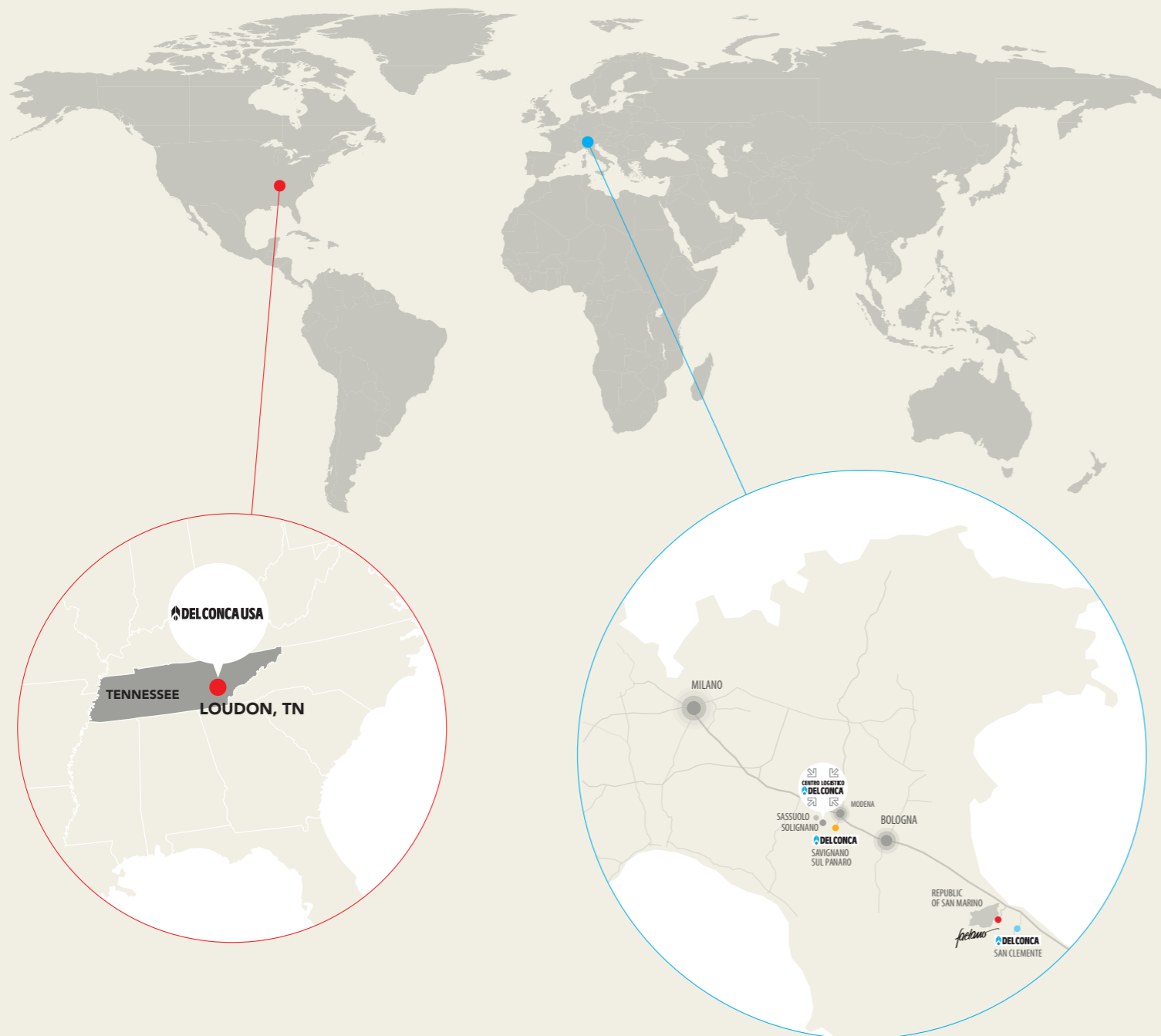

Del Conca USA, Inc.  
155 Del Conca Way - Loudon, TN 37774 - USA - Tel 865.657.3550 - Fax 865.657.3554  
www.delconcausa.com - sales@delconcausa.com



Del Conca USA headquarters



Del Conca USA showroom



# About Del Conca USA

The planning and design of each collection is conceived and carried out in Italy, in the Group's own research facility. An across-the-board creative process, the fruit of intensive teamwork involving designers, laboratory and quality technicians in order to ensure uniquely distinctive products; all made in the USA at the high-tech facility in Loudon, TN, the latest proud achievement of the Del Conca Group. The resulting products, incorporating dynamic taste and the latest trends, are generously endowed with cultural values, beauty and authenticity in order to enhance any architectural, residential or commercial space, both indoor and outdoor.





# Product Effect



Floor: Nature NA02 Fior di Bosco Rect.



Wall: New England HEN10 White Rect. | Floor: New England HEN10 White Rect.



Wall: Woodland Essential Design Rect. | Floor: Woodland HWL03 Natural



Wall: Fragrance FR04 Verde Acqua - FR10 Bianco | Floor: Fragrance FR10 Bianco



Wall: Essential HET05 Gray Rect. - Nature NA07 Calacatta Gold Rect. - Woodland HWL03 Natural Rect. | Floor: Essential HET05 Gray Rect.  
Counter: Essential HET05 Gray Card Mosaic



Floor: Cantina CA10 Bianco

Various textural effects showcase the projectual vision, offering immediate responses for today's changing context.



# Technology

Attention to detail, sensitivity to the environment and innovation are necessary to remain faithful to the vocation of producing ceramic tiles. The awareness of a historical and artistic heritage are drawn on for inspiration. An open and active vision of the evolution of the contemporary world, associated with creativity and originality, are the driving forces behind the development of superior quality surfaces that represent high quality Italian design culture.

An innovative production system is used to create porcelain stoneware with high-definition graphics, which is resistant to wear and chemical agents, easy to clean, and is suitable for spaces exposed to strong external stress.



The Del Conca USA factory is a hub of innovation, with state-of-the-art facilities to create the highest quality porcelain tile.

A production system that includes the collaborative effort of all departments is used to create porcelain stoneware with high definition graphics and material benefits.





## Our Team

Enthusiasm, energy and commitment are the underlying characteristics shared by the team of dynamic people that are the beating heart of Ceramica del Conca. The creation of a close-knit working group, which believes in the company's values and desire for continuous renewal, is an important resource; this great resource must be nurtured with great care and attention.

The ethical qualities, sense of responsibility and professional skills of each member of the team must be enhanced through refresher and training courses. In this way, through the experience and know-how acquired together with trusted partners and experienced collaborators, the cultural, technological and aesthetic content of the products and services is transformed into something unique, capable of generating and implementing ideas that are always different and innovative.

# Social Responsibility

The Del Conca Group has always been active in the social sphere also thanks to the Cino Mularoni Foundation, which aims to organize cultural and scientific events, encouraging studies and research and contributing to the training of young scholars and to supporting various publishing activities.

The Del Conca Group employs human and economic resources to promote a wide number of philanthropic activities, obtaining concrete results in the humanitarian field with solidarity projects all over the world.

Since the first project carried out in Indonesia in 2008, the focus has been on the importance of health and education as a basis for social and economic development of all the poorest countries in the world; since then the company has fully committed to this mission and has moved in that direction through the construction of schools, family houses, water networks, health centers and hospital wards.

Support was also provided to the populations strongly affected by the earthquakes in Italy in 2012 and 2016.



# Sustainability

Respect for the environment and natural resources, combined with attention to energy consumption, has always been a key goal which the company pursues. The aim is to offer customers a product that not only has high quality technical and aesthetic features but that is also manufactured according to sustainability criteria. The environmental policy is implemented by raising the awareness of employees and suppliers on ecology and energy saving issues.

The company's environmental philosophy is attentive to the environment and to people's well-being. It is based on the complete internal re-use of the industrial water produced during the company and third-party's processing cycles, the reduction of CO2 emissions into the atmosphere in line with the requirements of the Kyoto Protocol, the recovery of all non-fired production waste during production and proper waste management.





# User's Guide

- 1 Name of the collection
- 2 Available sizes
- 3 Collection code
- 4 Colors summary
- 5 Effect
- 6 Technical characteristics
- 7 Graphics number
- 8 Packaging specifications
- 9 Matching Outdoor product (if available)



1

2

3

## New England

24"x48" 24"x24" 12"x24" 4"x12" Rectified Collection

24"x48" - 40x100 cm

24"x24" - 60x60 cm

12"x24" - 30x60 cm

4"x12" - 10x30 cm

Colored Body Porcelain Stoneware

New England  
HEN10 White

New England  
HEN01 Ivory

New England  
HEN05 Cold Gray

New England  
HEN08 Anthracite

ANSI A 137.1 compliant

WALL / FLOOR

MODERATE

0.34 in / 8.5 mm

ASTM C 1028 RESISTANT

ASTM C 573 -0.5%

ASTM C 659 CLASS A  
ASTM C 1179 CLASS A

ANSI A328.3-2021 (DCCP) V2A2

HEAVY USE

Graphics number

Size	New England HEN10 White	New England HEN01 Ivory	New England HEN05 Cold Gray	New England HEN08 Anthracite
24"x48"	15	10	10	10
24"x24"	20	20	20	20
12"x24"	40	40	40	40

Packaging

Size	Pieces	Box		Stack	
		Sq Ft	Lbs	Sq Ft	Lbs
24"x48"	2	15.50	41.00	34	158.00
24"x24"	8	22.75	61.50	24	158.00
12"x24"	8	15.50	41.40	32	152.40
4"x12"	36	11.65	46.45	40	164.00
12"x12" <i>mosaic</i>	16	9.70	-	-	-
12"x12" <i>herringbone mosaic</i>	10	8.60	-	-	-
12"x12" <i>mix</i>	10	9.70	-	-	-
4"x24" <i>subway</i>	10	-	-	-	-

HEN

Stone Effect

95

# User's Guide

- 1 Name of the collection
- 2 Available sizes
- 3 Item code
- 4 Item description
- 5 Size in inches and cm
- 6 Collection code
- 7 Effect

**1** Name of the collection

**2** Available sizes

**3** Item code

**4** Item description

**5** Size in inches and cm

**6** Collection code

**7** Effect

**102** \*More details on page 248-249

**103** \*More details on page 248-249

# Wood Effect

Woodchic	28
Woodland	36
Woodscape	42
Hardin Valley	48
Voyage	54
Lumber	58
Barton Creek	64





# Woodchic

8"x48" 8"x32"



8"x48" . 20x120 cm  
Rectified



8"x32" . 20x80 cm  
Pressed

Glazed Porcelain Stoneware

ANSI A 137.1 compliant



WALL / FLOOR



MODERATE



0.34 in  
8.5 mm



ASTM C 1026  
RESISTANT



ASTM C 373  
~0.1%



ASTM C 650: CLASS A  
ASTM C 1378: CLASS A



ANSI A326.3: 2021.  
(DCOF): ≥0,42



MEDIUM USE

8"x48" Rectified - 8"x32" Pressed



Woodchic  
WC10 White



Woodchic  
WC05 Gray



Woodchic  
WC03 Natural





Woodchic  
WC09 Chestnut

## Graphics number

Sizes	Woodchic WC10 White	Woodchic WC05 Gray	Woodchic WC03 Natural	Woodchic WC09 Chestnut
8"x48"	42	42	42	42
8"x32"	42	42	42	42

## Packaging

Sizes						
	Pieces	Sq.Ft.	Lbs.	Boxes	Sq.Ft.	Lbs.
8"x48"	5	12.92	49.12	48	620.16	2400.00
8"x32"	7	12.10	47.84	54	653.40	2583.30



# Woodchic

8"x48" 8"x32"

WC



Wood Effect

Wood Effect



# Woodchic

8"x48" 8"x32"

WC

Wood Effect



Wood Effect



# Woodchic

8"x48" 8"x32"

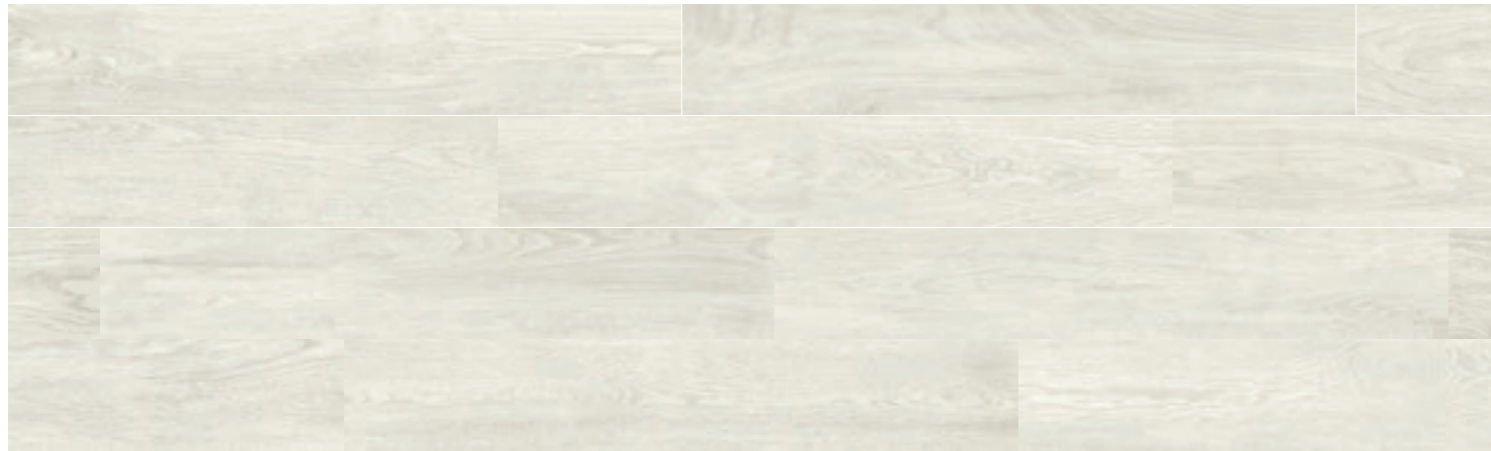

Woodchic WC10 White Rect. 8"x48"

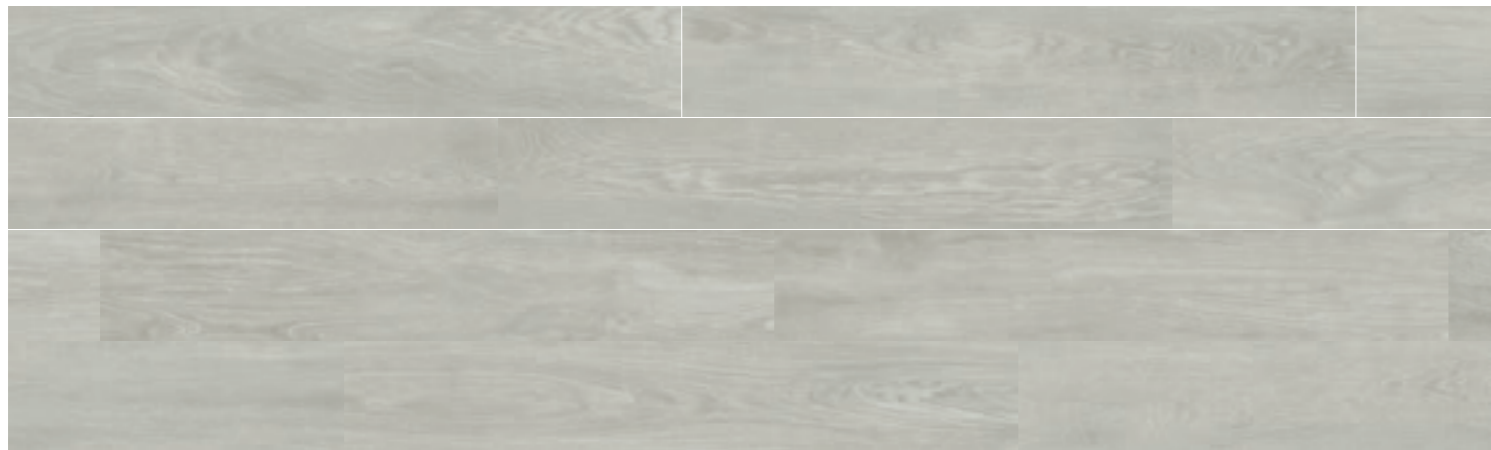

Woodchic WC05 Gray Rect. 8"x48"

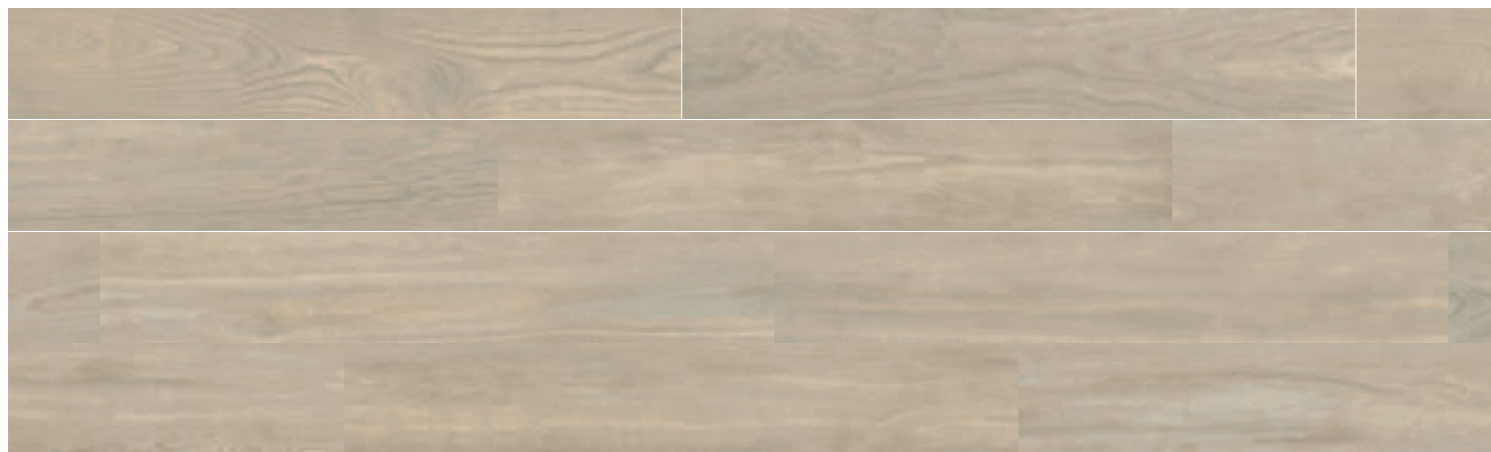

Woodchic WC03 Natural Rect. 8"x48"

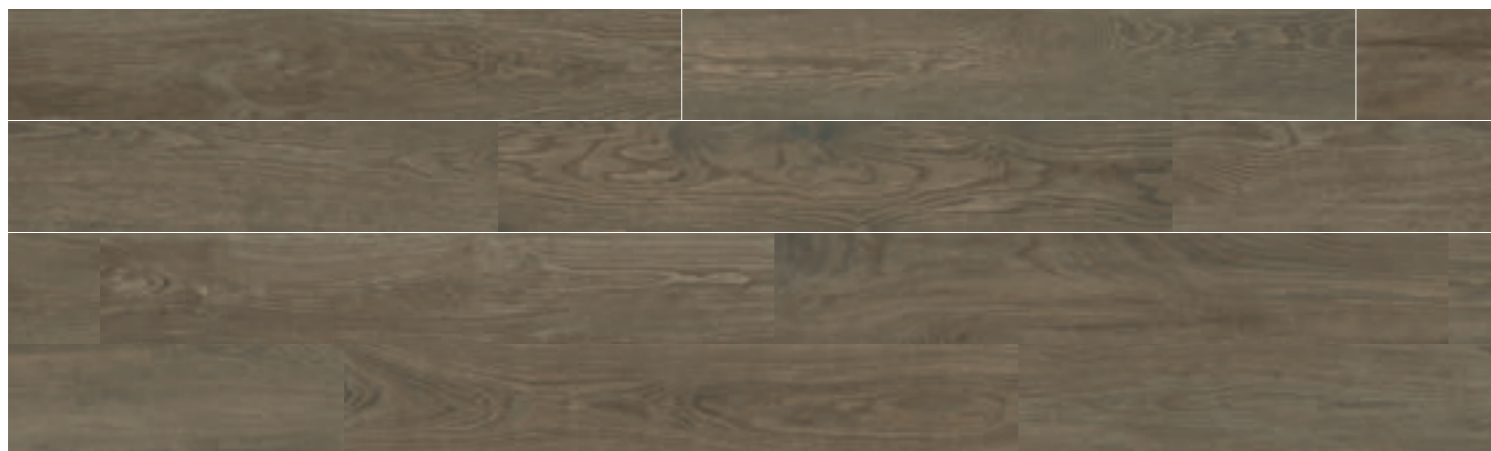

Woodchic WC09 Chestnut Rect. 8"x48"



**21WC10R**  
Woodchic WC10 White Rect.  
8"x48" . 20x120 cm



**21WC05R**  
Woodchic WC05 Gray Rect.  
8"x48" . 20x120 cm



**21WC03R**  
Woodchic WC03 Natural Rect.  
8"x48" . 20x120 cm



**21WC09R**  
Woodchic WC09 Chestnut Rect.  
8"x48" . 20x120 cm



**27WC10**  
Woodchic WC10 White  
8"x32" . 20x80 cm



**27WC05**  
Woodchic WC05 Gray  
8"x32" . 20x80 cm



**27WC03**  
Woodchic WC03 Natural  
8"x32" . 20x80 cm



**27WC09**  
Woodchic WC09 Chestnut  
8"x32" . 20x80 cm

Wood Effect

Wood Effect





# Woodland

8"x48"



8"x48" . 20x120 cm

Colored Body Porcelain Stoneware

ANSI A 137.1 compliant



WALL / FLOOR



MODERATE



0.34 in  
8.5 mm



ASTM C 1026  
RESISTANT



ASTM C 373  
~0.1%



ASTM C 650: CLASS A  
ASTM C 1378: CLASS A



ANSI A326.3: 2021.  
(DCOF): ≥0,42



MEDIUM USE

Rectified Collection



Woodland  
HWL05 Gray



Woodland  
HWL03 Natural

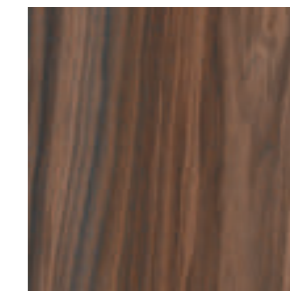



Woodland  
HWL09 Walnut

### Graphics number

Sizes	Woodland HWL03 Natural	Woodland HWL05 Gray	Woodland HWL09 Walnut
8"x48"	33	33	33

### Packaging

Sizes	Pieces					
		Sq.Ft.	Lbs.	Boxes	Sq.Ft.	Lbs.
8"x48"	5	12.92	49.12	48	620.16	2400.00
12"x24" essential design	8	15.50	61.40	32	496.00	1932.48



# Woodland

8"x48"

HWL

Wood Effect



Wood Effect





Woodland HWL05 Gray Rect. 8"x48"



Woodland HWL03 Natural Rect. 8"x48"

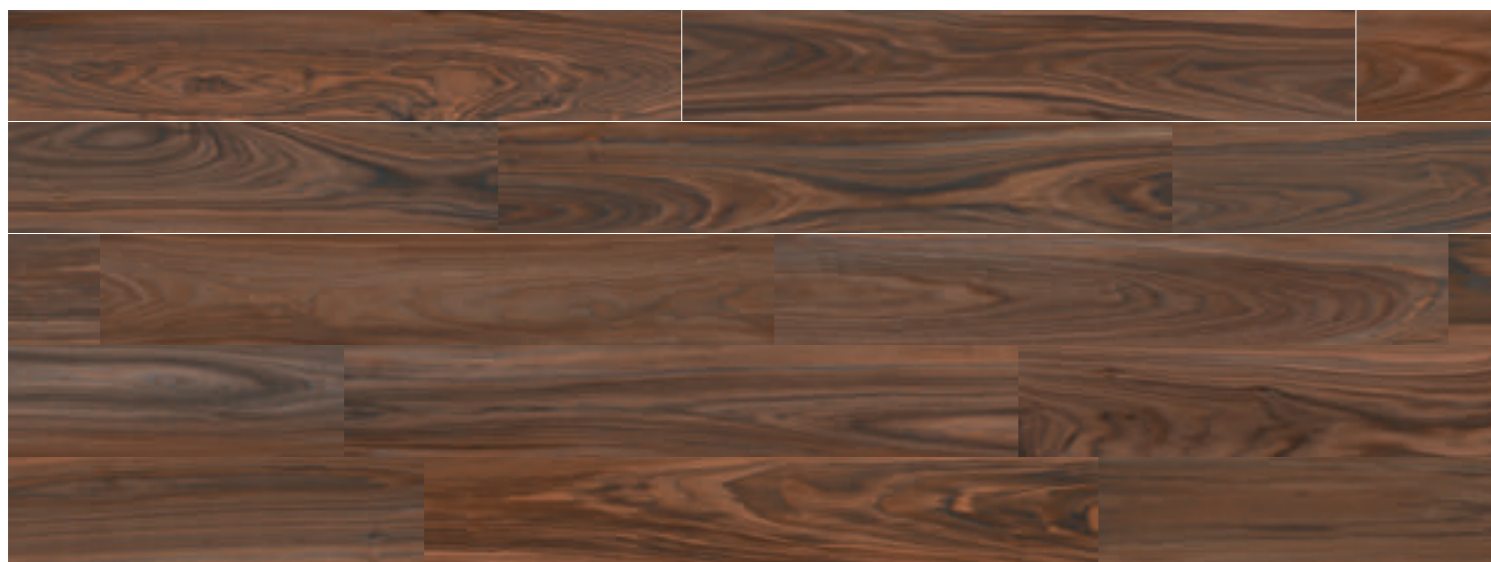

Woodland HWL09 Walnut Rect. 8"x48"

# Woodland

8"x48"



**GLWL05R**  
Woodland HWL05 Gray Rect.  
8"x48" . 20x120 cm



**GLWL03R**  
Woodland HWL03 Natural Rect.  
8"x48" . 20x120 cm



**GLWL09R**  
Woodland HWL09 Walnut Rect.  
8"x48" . 20x120 cm

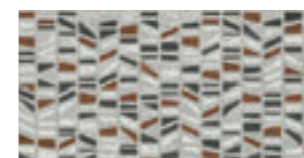

**G8ETDESIGNR**  
Essential Design Rect.  
12"x24" . 30x60 cm

The Design decoration can be used in both wall and floor tiles, and also in combination with the Woodland series.



# Woodscape

8"x48"



8"x48" . 20x120 cm

Glazed Porcelain Stoneware

ANSI A 137.1 compliant



WALL / FLOOR



MODERATE



0.34 in  
8.5 mm



ASTM C 1026  
RESISTANT



ASTM C 373  
~0.1%



ASTM C 650: CLASS A  
ASTM C 1378: CLASS A



ANSI A326.3: 2021.  
(DCOF): ≥0,42



MEDIUM USE

Rectified Collection



Woodscape  
WS10 Bianco

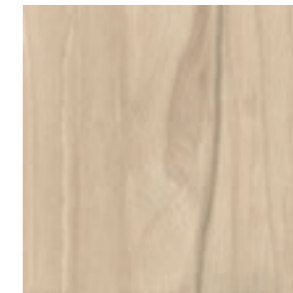

Woodscape  
WS03 Natural

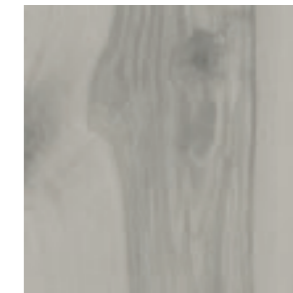



Woodscape  
WS05 Gray

### Graphics number

Sizes	Woodscape WS10 Bianco	Woodscape WS03 Natural	Woodscape WS05 Gray
8"x48"	21	20	21

### Packaging

Sizes	Pieces					
		Sq.Ft.	Lbs.	Boxes	Sq.Ft.	Lbs.
8"x48"	5	12.92	49.12	48	620.16	2400.00
12"x12" mosaic	10	9.70	-	-	-	-



# Woodscape

8"x48"

WS



Wood Effect

Wood Effect





Floor: Woodscape WS05 Gray Rect. 8"x48"

# Woodscape

8"x48"



**21WS10R**  
Woodscape WS10 Bianco Rect.  
8"x48" . 20x120 cm



**21WS03R**  
Woodscape WS03 Natural Rect.  
8"x48" . 20x120 cm



**21WS05R**  
Woodscape WS05 Gray Rect.  
8"x48" . 20x120 cm

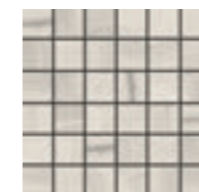

**32WS10MO**  
Woodscape WS10 Bianco Mosaic\*  
(sheet 12"x12" . 30x30 cm)

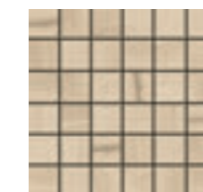

**32WS03MO**  
Woodscape WS03 Natural Mosaic\*  
(sheet 12"x12" . 30x30 cm)



**32WS05MO**  
Woodscape WS05 Gray Mosaic\*  
(sheet 12"x12" . 30x30 cm)

\*More details on page. 248-249





# Hardin Valley

8"x48"

Pressed Collection



8"x48" . 20x120 cm

Colored Body Porcelain Stoneware

ANSI A 137.1 compliant



WALL / FLOOR



MODERATE



0.34 in  
8.5 mm



ASTM C 1026  
RESISTANT



ASTM C 373  
~0.1%



ASTM C 650: CLASS A  
ASTM C 1378: CLASS A



ANSI A326.3: 2021.  
(DCOF): ≥0,42



HEAVY USE



Hardin Valley  
HHV10 Bianco



Hardin Valley  
HHV03 Natural



Hardin Valley  
HHV05 Gray

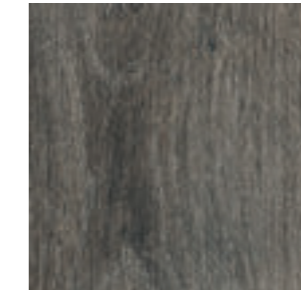

Hardin Valley  
HHV08 Nero

## Graphics number

Sizes	Hardin Valley HHV10 Bianco	Hardin Valley HHV03 Natural	Hardin Valley HHV05 Gray	Hardin Valley HHV08 Nero
8"x48"	20	20	20	20

## Packaging

Sizes						
	Pieces	Sq.Ft.	Lbs.	Boxes	Sq.Ft.	Lbs.
8"x48"	5	12.92	49.12	48	620.16	2400.00



# Hardin Valley

8"x48"

HHV



Wood Effect

Wood Effect





Floor: Hardin Valley HHV10 Bianco 8"x48"

# Hardin Valley

8"x48"



**GLHV10**  
Hardin Valley HHV10 Bianco  
8"x48" . 20x120 cm



**GLHV03**  
Hardin Valley HHV03 Natural  
8"x48" . 20x120 cm



**GLHV05**  
Hardin Valley HHV05 Gray  
8"x48" . 20x120 cm



**GLHV08**  
Hardin Valley HHV08 Nero  
8"x48" . 20x120 cm





# Voyage

8"x32" 6"x24"

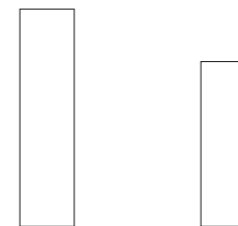

8"x32" . 20x80 cm    6"x24" . 15x60 cm

Glazed Porcelain Stoneware

ANSI A 137.1 compliant



WALL / FLOOR



HIGH



0.34 in  
8.5 mm



ASTM C 1026  
RESISTANT



ASTM C 373  
~0.1%



ASTM C 650: CLASS A  
ASTM C 1378: CLASS A



ANSI A326.3: 2021.  
(DCOF): ≥0,42



MEDIUM USE

Pressed Collection



Voyage  
VO10 Bianco



Voyage  
VO07 Taupe



Voyage  
VO05 Gray





Voyage  
VO13 Dark Brown

Graphics number

Sizes	Voyage VO10 Bianco	Voyage VO07 Taupe	Voyage VO05 Gray	Voyage VO13 Dark Brown
8"x32"	29	29	29	29
6"x24"	58	58	58	58

Packaging

Sizes						
	Pieces	Sq.Ft.	Lbs.	Boxes	Sq.Ft.	Lbs.
8"x32"	7	12.10	47.84	54	653.40	2583.30
6"x24"	16	15.51	60.50	40	620.40	2460.00



# Voyage

8"x32" 6"x24"



Floor: Voyage VO10 Bianco 8"x32"



**27VO10**  
Voyage VO10 Bianco  
8"x32" . 20x80 cm

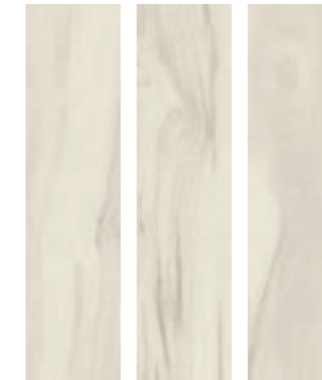

**17VO10**  
Voyage VO10 Bianco  
6"x24" . 15x60 cm



**27VO05**  
Voyage VO05 Gray  
8"x32" . 20x80 cm



**17VO05**  
Voyage VO05 Gray  
6"x24" . 15x60 cm



**27VO07**  
Voyage VO07 Taupe  
8"x32" . 20x80 cm

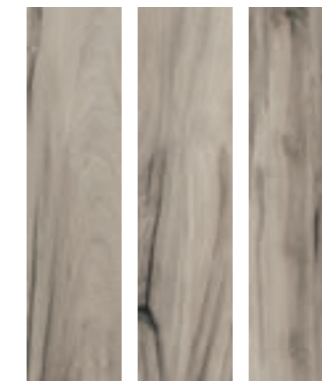

**17VO07**  
Voyage VO07 Taupe  
6"x24" . 15x60 cm



**27VO13**  
Voyage VO13 Dark Brown  
8"x32" . 20x80 cm



**17VO13**  
Voyage VO13 Dark Brown  
6"x24" . 15x60 cm



# Lumber

6"x24"



6"x24" . 15x60 cm

Glazed Porcelain Stoneware

ANSI A 137.1 compliant



WALL / FLOOR



HIGH



0.34 in  
8.5 mm



ASTM C 1026  
RESISTANT



ASTM C 373  
~0.1%



ASTM C 650: CLASS A  
ASTM C 1378: CLASS A



ANSI A326.3: 2021.  
(DCOF): ≥0,42



MEDIUM USE

Pressed Collection



Lumber  
LU10 Bianco



Lumber  
LU05 Gray





Lumber  
LU03 Honey

Graphics number

Sizes	Lumber LU10 Bianco	Lumber LU05 Gray	Lumber LU03 Honey
6"x24"	16	56	20

Packaging

Sizes						
	Pieces	Sq.Ft.	Lbs.	Boxes	Sq.Ft.	Lbs.
6"x24"	13	12.60	55.14	44	554.40	2426.52



# Lumber

6"x24"

Wood Effect



Wood Effect





Wall: Lumber LU05 Gray 6"x24" | Floor: Lumber LU05 Gray 6"x24"

# Lumber

6"x24"



**17LU10**  
Lumber LU10 Bianco  
6"x24" . 15x60 cm



**17LU05**  
Lumber LU05 Gray  
6"x24" . 15x60 cm



**17LU03**  
Lumber LU03 Honey  
6"x24" . 15x60 cm





# Barton Creek

8"x32"

Pressed Collection



8"x32" . 20x80 cm

Glazed Porcelain Stoneware



Barton Creek  
BC05 Gray

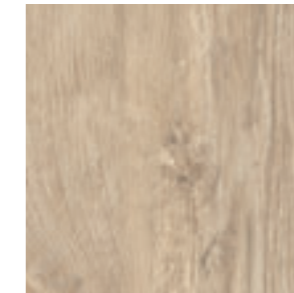

Barton Creek  
BC01 Beige



Barton Creek  
BC09 Noce

ANSI A 137.1 compliant



WALL / FLOOR



HIGH



0.34 in  
8.5 mm



ASTM C 1026  
RESISTANT



ASTM C 373  
~0.1%



ASTM C 650: CLASS A  
ASTM C 1378: CLASS A



ANSI A326.3: 2021.  
(DCOF): ≥0,42





MEDIUM USE

## Graphics number

Sizes	Barton Creek BC05 Gray	Barton Creek BC01 Beige	Barton Creek BC09 Noce
8"x32"	15	28	16

## Packaging

Sizes						
	Pieces	Sq.Ft.	Lbs.	Boxes	Sq.Ft.	Lbs.
8"x32"	7	12.10	47.84	54	653.40	2583.30



# Barton Creek

8"x32"

BC



Wood Effect

Wood Effect



Wood Effect

# Barton Creek

8"x32"



**27BC05**  
 Barton Creek BC05 Gray  
 8"x32" . 20x80 cm



**27BC01**  
 Barton Creek BC01 Beige  
 8"x32" . 20x80 cm



**27BC09**  
 Barton Creek BC09 Noce  
 8"x32" . 20x80 cm

Wood Effect



# Stone Effect

Horizons	72
Endless	86
New England	94
Verona	106
Quartzite	114
Navona	122
Chamonix	130
West 57th	140
Neopolis	150
Gotham	156

# Horizons

24"x48" 24"x24" 12"x24" 4"x12" Rectified Collection

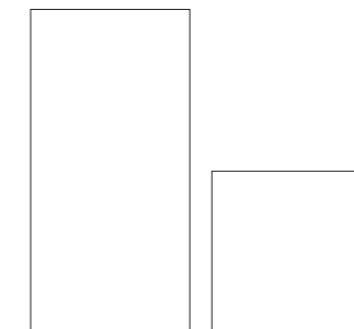

24"x48" . 60x120 cm 24"x24" . 60x60 cm



12"x24" . 30x60 cm 4"x12" . 10x30 cm

Colored Body Porcelain Stoneware

ANSI A 137.1 compliant

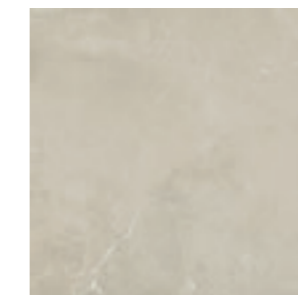
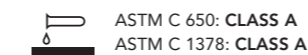
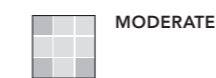

Horizons  
HOR01 Ivory



Horizons  
HOR10 White



Horizons  
HOR05 Gray





Horizons  
HOR08 Graphite

### Graphics number

Sizes	Horizons HOR01 Ivory	Horizons HOR10 White	Horizons HOR05 Gray	Horizons HOR08 Graphite
24"x48"	14	14	14	14
24"x24"	28	28	28	28
12"x24"	56	56	56	56

### Packaging

Sizes	Pieces						
		Sq.Ft.	Lbs.	Boxes	Sq.Ft.	Lbs.	
24"x48"	2	15.50	61.00	36	558.00	2236.00	
24"x24"	6	23.25	91.50	24	558.00	2236.00	
12"x24"	8	15.50	61.40	32	496.00	1932.48	
12"x12" mosaic	10	9.70	-	-	-	-	
10"x12" hexagon	10	8.40	-	-	-	-	
4"x24" bullnose	10	-	-	-	-	-	



# Horizons

24"x48" 24"x24" 12"x24" 4"x12"

HOR



Stone Effect

Stone Effect



# Horizons

24"x48" 24"x24" 12"x24" 4"x12"

HOR

Stone Effect



76 Wall: Horizons HOR08 Graphite Hexagon 10"x12" - Horizons HOR05 Gray Rect. 24"x48" | Floor: Horizons HOR05 Gray Rect. 24"x24"



Stone Effect

77 Wall: Horizons HOR08 Graphite Hexagon 10"x12" - Horizons HOR05 Gray Rect. 24"x48" | Floor: Horizons HOR05 Gray Rect. 24"x24"



# Horizons

24"x48" 24"x24" 12"x24" 4"x12"

HOR

Stone Effect



Stone Effect



# Horizons

24"x48" 24"x24" 12"x24" 4"x12"

HOR



Stone Effect

Stone Effect



# Horizons

24"x48" 24"x24" 12"x24" 4"x12"

Stone Effect

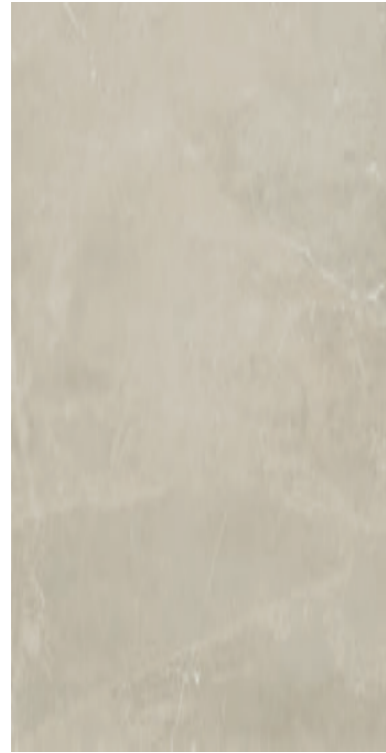

**GCOR01R**  
Horizons HOR01 Ivory Rect.  
24"x48" . 60x120 cm



**G8OR01R**  
Horizons HOR01 Ivory Rect.  
12"x24" . 30x60 cm



**G9OR01R**  
Horizons HOR01 Ivory Rect.  
24"x24" . 60x60 cm

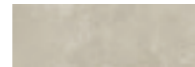

**30OR01**  
Horizons HOR01 Ivory Rect.  
4"x12" . 10x30 cm



**32OR01MO**  
Horizons HOR01 Ivory Mosaic\*  
1<sup>3</sup>/<sub>8</sub>"x1<sup>3</sup>/<sub>8</sub>" . 3,5x3,5 cm  
(sheet 12"x12" . 30x30 cm)



**32OR01HEX**  
Horizons HOR01 Ivory Hexagon\*  
4"x4" . 10x10 cm  
(sheet 10"x12" 26x30 cm)



**13OR01**  
Horizons HOR01 Ivory Bullnose  
4"x24" . 10x60 cm

\*More details on page. 248-249

Stone Effect

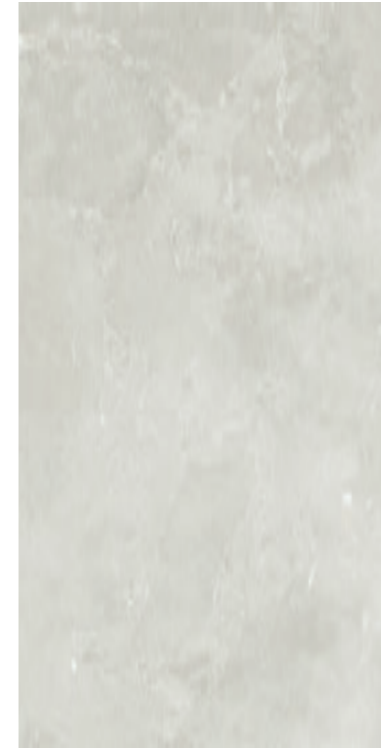

**GCOR10R**  
Horizons HOR10 White Rect.  
24"x48" . 60x120 cm



**G8OR10R**  
Horizons HOR10 White Rect.  
12"x24" . 30x60 cm



**G9OR10R**  
Horizons HOR10 White Rect.  
24"x24" . 60x60 cm

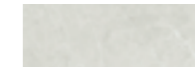

**30OR10**  
Horizons HOR10 White Rect.  
4"x12" . 10x30 cm



**32OR10MO**  
Horizons HOR10 White Mosaic\*  
1<sup>3</sup>/<sub>8</sub>"x1<sup>3</sup>/<sub>8</sub>" . 3,5x3,5 cm  
(sheet 12"x12" . 30x30 cm)



**32OR10HEX**  
Horizons HOR10 White Hexagon\*  
4"x4" . 10x10 cm  
(sheet 10"x12" 26x30 cm)



**13OR10**  
Horizons HOR10 White Bullnose  
4"x24" . 10x60 cm

\*More details on page. 248-249

# Horizons

24"x48" 24"x24" 12"x24" 4"x12"

Stone Effect

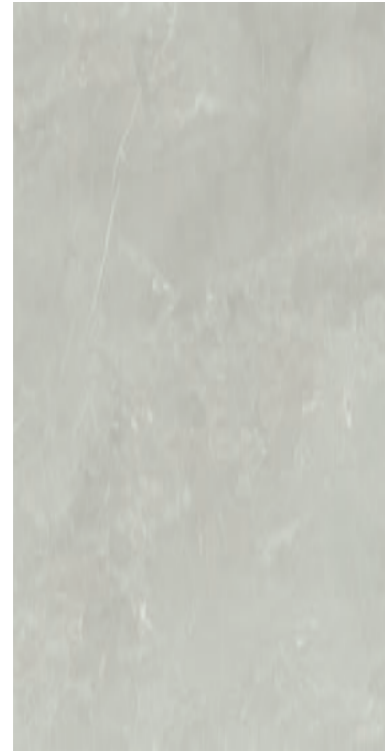

**GCOR05R**  
Horizons HOR05 Gray Rect.  
24"x48" . 60x120 cm



**G8OR05R**  
Horizons HOR05 Gray Rect.  
12"x24" . 30x60 cm

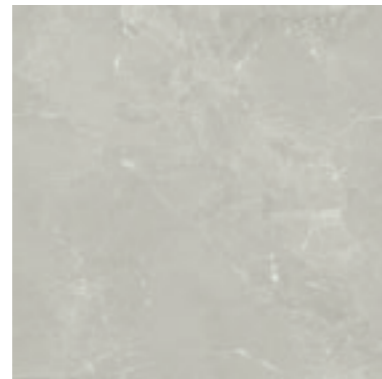

**G9OR05R**  
Horizons HOR05 Gray Rect.  
24"x24" . 60x60 cm



**30OR05**  
Horizons HOR05 Gray Rect.  
4"x12" . 10x30 cm



**32OR05MO**  
Horizons HOR05 Gray Mosaic\*  
1<sup>3</sup>/<sub>8</sub>"x1<sup>3</sup>/<sub>8</sub>" . 3,5x3,5 cm  
(sheet 12"x12" . 30x30 cm)



**32OR05HEX**  
Horizons HOR05 Gray Hexagon\*  
4"x4" . 10x10 cm  
(sheet 10"x12" 26x30 cm)



**13OR05**  
Horizons HOR05 Gray Bullnose  
4"x24" . 10x60 cm

\*More details on page. 248-249

Stone Effect

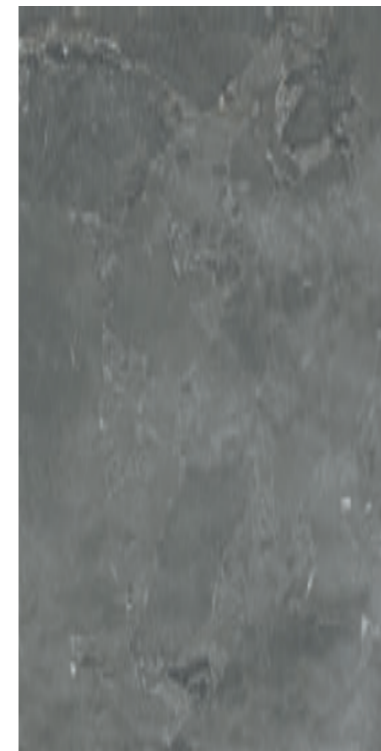

**GCOR08R**  
Horizons HOR08 Graphite Rect.  
24"x48" . 60x120 cm



**G8OR08R**  
Horizons HOR08 Graphite Rect.  
12"x24" . 30x60 cm

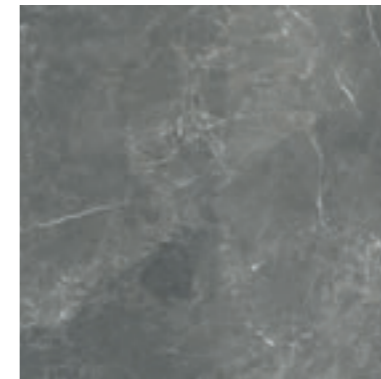

**G9OR08R**  
Horizons HOR08 Graphite Rect.  
24"x24" . 60x60 cm



**30OR08**  
Horizons HOR08 Graphite Rect.  
4"x12" . 10x30 cm

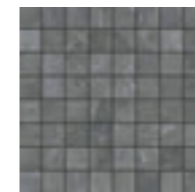

**32OR08MO**  
Horizons HOR08 Graphite Mosaic\*  
1<sup>3</sup>/<sub>8</sub>"x1<sup>3</sup>/<sub>8</sub>" . 3,5x3,5 cm  
(sheet 12"x12" . 30x30 cm)

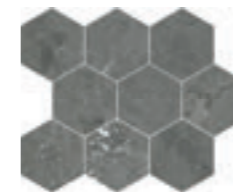

**32OR08HEX**  
Horizons HOR08 Graphite Hexagon\*  
4"x4" . 10x10 cm  
(sheet 10"x12" 26x30 cm)



**13OR08**  
Horizons HOR08 Graphite Bullnose  
4"x24" . 10x60 cm

\*More details on page. 248-249



# Endless

12"x24"



12"x24" . 30x60 cm

Glazed Porcelain Stoneware

ANSI A 137.1 compliant



WALL / FLOOR



LOW



0.34 in  
8.5 mm



ASTM C 1026  
RESISTANT



ASTM C 373  
~0.1%



ASTM C 650: CLASS A  
ASTM C 1378: CLASS A



ANSI A326.3: 2021.  
(DCOF): ≥0,42



MEDIUM USE

Pressed Collection

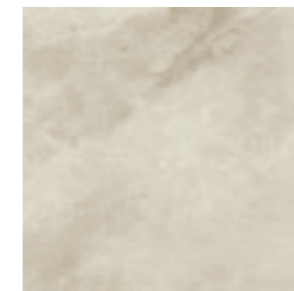

Endless  
ES01 Beige

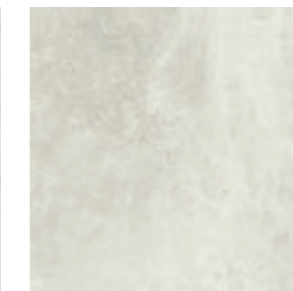

Endless  
ES10 White

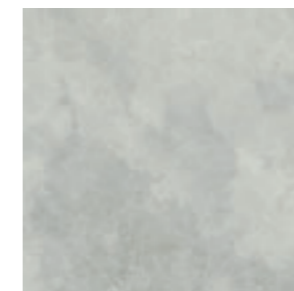

Endless  
ES05 Warm Gray





Endless  
ES07 Stone

### Graphics number

Sizes	Endless ES10 White	Endless ES01 Beige	Endless ES05 Warm Gray	Endless ES07 Stone
12"x24"	56	56	56	56

### Packaging

Sizes	Pieces					
		Sq.Ft.	Lbs.	Boxes	Sq.Ft.	Lbs.
12"x24"	8	15.50	61.40	32	497.28	1965.00
12"x12" mosaic	10	9.70	-	-	-	-
3"x12" bullnose	20	-	-	-	-	-

# Endless

12"x24"

ES



Stone Effect

Stone Effect



# Endless

12"x24"

ES



Stone Effect

Stone Effect





Stone Effect

Stone Effect

# Endless

12"x24"



**63ES01**  
Endless ES01 Beige  
12"x24" . 30x60 cm



**63ES10**  
Endless ES10 White  
12"x24" . 30x60 cm



**63ES05**  
Endless ES05 Warm Gray  
12"x24" . 30x60 cm



**63ES07**  
Endless ES07 Stone  
12"x24" . 30x60 cm

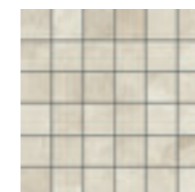

**32ES01MO**  
Endless ES01 Beige Mosaic\*  
2"x2" . 5x5 cm  
(sheet 12"x12" . 30x30 cm)



**32ES10MO**  
Endless ES10 White Mosaic\*  
2"x2" . 5x5 cm  
(sheet 12"x12" . 30x30 cm)



**32ES05MO**  
Endless ES05 Warm Gray Mosaic\*  
2"x2" . 5x5 cm  
(sheet 12"x12" . 30x30 cm)

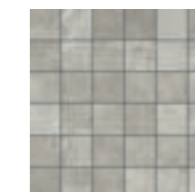

**32ES07MO**  
Endless ES07 Stone Mosaic\*  
2"x2" . 5x5 cm  
(sheet 12"x12" . 30x30 cm)



**13ES01**  
Endless ES01 Beige Bullnose  
3"x12" . 8x30 cm



**13ES10**  
Endless ES10 White Bullnose  
3"x12" . 8x30 cm



**13ES05**  
Endless ES05 Warm Gray Bullnose  
3"x12" . 8x30 cm



**13ES07**  
Endless ES07 Stone Bullnose  
3"x12" . 8x30 cm



# New England

24"x48" 24"x24" 12"x24" 4"x12" Rectified Collection

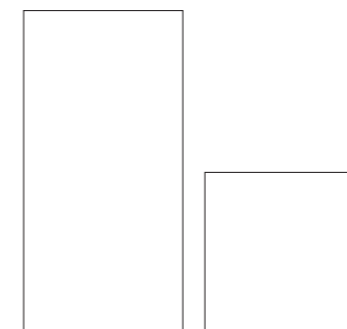

24"x48" . 60x120 cm 24"x24" . 60x60 cm



12"x24" . 30x60 cm 4"x12" . 10x30 cm

Colored Body Porcelain Stoneware

ANSI A 137.1 compliant



WALL / FLOOR



MODERATE



0.34 in  
8.5 mm



ASTM C 1026  
RESISTANT



ASTM C 373  
~0.1%



ASTM C 650: CLASS A  
ASTM C 1378: CLASS A



ANSI A326.3: 2021.  
(DCOF): ≥0,42



HEAVY USE



New England  
HEN10 White

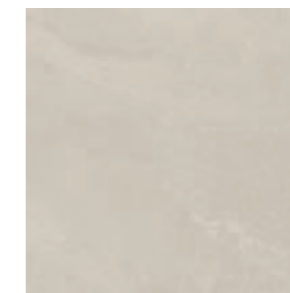

New England  
HEN01 Ivory

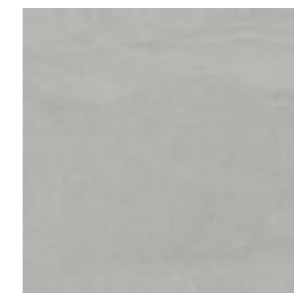

New England  
HEN05 Cold Gray



New England  
HEN08 Anthracite

## Graphics number

Sizes	New England HEN10 White	New England HEN01 Ivory	New England HEN05 Cold Gray	New England HEN08 Anthracite
24"x48"	10	10	10	10
24"x24"	20	20	20	20
12"x24"	40	40	40	40

## Packaging

Sizes	Pieces					
		Sq.Ft.	Lbs.	Boxes	Sq.Ft.	Lbs.
24"x48"	2	15.50	61.00	36	558.00	2236.00
24"x24"	6	23.25	91.50	24	558.00	2236.00
12"x24"	8	15.50	61.40	32	496.00	1932.48
4"x12"	36	11.65	46,45	40	466.00	1858.00
12"x12" mosaic	10	9.70	-	-	-	-
12"x14" herringbone mosaic	10	8.60	-	-	-	-
12"x12" brick	10	9.70	-	-	-	-
4"x24" bullnose	10	-	-	-	-	-

## New England 2

due2 Porcelain Pavers available  
in White, Ivory, Cold Gray



# New England

24"x48" 24"x24" 12"x24" 4"x12"

Stone Effect



Stone Effect





# New England

24"x48" 24"x24" 12"x24" 4"x12"

Stone Effect



98 Wall: New England HEN01 Ivory Rect. 4"x12" | Floor: New England HEN01 Ivory Rect. 24"x48" | Counter: New England HEN01 Ivory Rect. 4"x12"

Stone Effect



Wall: New England HEN01 Ivory Rect. 4"x12" 99



# New England

24"x48" 24"x24" 12"x24" 4"x12"

Stone Effect



100 Wall: New England HEN01 Ivory Rect. 24"x48" - New England HEN01 Ivory Brick 12"x12" (sheet) | Floor: New England HEN01 Ivory Rect. 24"x48"

Stone Effect



101 Wall: New England HEN10 White Rect. 24"x24" | Floor: New England HEN10 White Rect. 24"x24"



# New England

24"x48" 24"x24" 12"x24" 4"x12"

Stone Effect

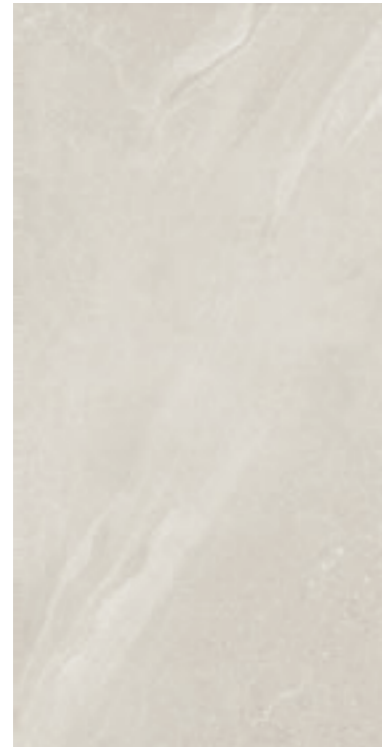

**GCEN10R**  
New England  
HEN10 White Rect.  
24"x48" . 60x120 cm



**30EN10**  
New England  
HEN10 White Rect.  
4"x12" . 10x30 cm

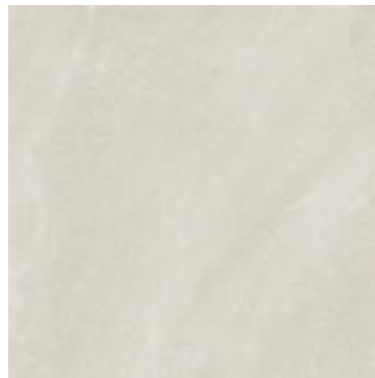

**G9EN10R**  
New England  
HEN10 White Rect.  
24"x24" . 60x60 cm



**G8EN10R**  
New England  
HEN10 White Rect.  
12"x24" . 30x60 cm

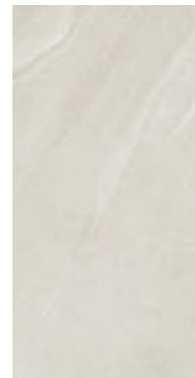

**G8EN10GRIR**  
New England  
HEN10 White **Grip** Rect.  
12"x24" . 30x60 cm

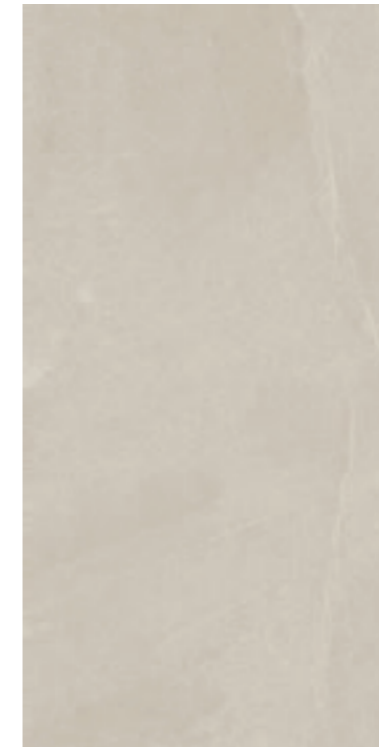

**GCEN01R**  
New England  
HEN01 Ivory Rect.  
24"x48" . 60x120 cm

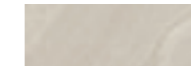

**30EN01**  
New England  
HEN01 Ivory Rect.  
4"x12" . 10x30 cm

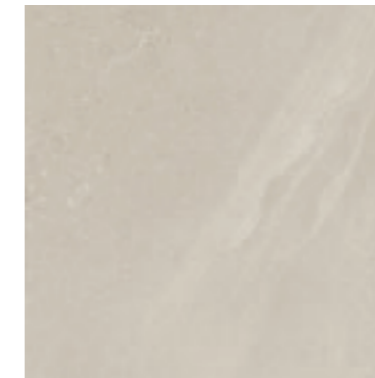

**G9EN01R**  
New England  
HEN01 Ivory Rect.  
24"x24" . 60x60 cm



**G8EN01R**  
New England  
HEN01 Ivory Rect.  
12"x24" . 30x60 cm

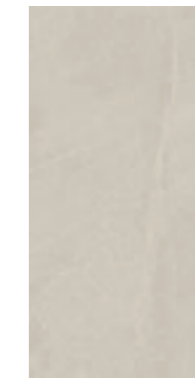

**G8EN01GRIR**  
New England  
HEN01 Ivory **Grip** Rect.  
12"x24" . 30x60 cm



**G3EN10MO**  
New England  
HEN10 White Mosaic\*  
1 3/8"x 1 3/8" . 3,5x3,5 cm  
(sheet 12"x12" . 30x30 cm)



**G3EN10HB**  
New England  
HEN10 White Herringbone Mosaic\*  
1 7/8"x 3 7/8" . 4,7x9,7 cm  
(sheet 12"x14" . 31x35 cm)



**G3EN10BR**  
New England  
HEN10 White Brick\*  
1 7/8"x 3 7/8" . 4,7x9,7 cm  
(sheet 12"x12" 30x30 cm)



**G3EN01MO**  
New England  
HEN01 Ivory Mosaic\*  
1 3/8"x 1 3/8" . 3,5x3,5 cm  
(sheet 12"x12" . 30x30 cm)



**G3EN01HB**  
New England  
HEN01 Ivory Herringbone Mosaic\*  
1 7/8"x 3 7/8" . 4,7x9,7 cm  
(sheet 12"x14" . 31x35 cm)



**G3EN01BR**  
New England  
HEN01 Ivory Brick\*  
1 7/8"x 3 7/8" . 4,7x9,7 cm  
(sheet 12"x12" 30x30 cm)



**G0EN10**  
New England  
HEN10 White Bullnose  
4"x24" . 10x60 cm



**G0EN01**  
New England  
HEN01 Ivory Bullnose  
4"x24" . 10x60 cm

Stone Effect



# New England

24"x48" 24"x24" 12"x24" 4"x12"

Stone Effect



**GCEN05R**  
New England  
HEN05 Cold Gray Rect.  
24"x48" . 60x120 cm



**30EN05**  
New England  
HEN05 Cold Gray Rect.  
4"x12" . 10x30 cm



**G9EN05R**  
New England  
HEN05 Cold Gray Rect.  
24"x24" . 60x60 cm



**G8EN05R**  
New England  
HEN05 Cold Gray Rect.  
12"x24" . 30x60 cm

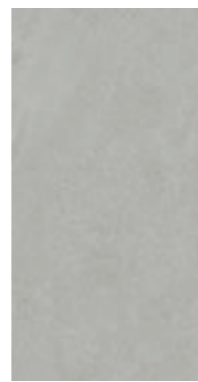

**G8EN05GRIP**  
New England  
HEN05 Cold Gray **Grip** Rect.  
12"x24" . 30x60 cm



**GCEN08R**  
New England  
HEN08 Anthracite Rect.  
24"x48" . 60x120 cm



**30EN08**  
New England  
HEN08 Anthracite Rect.  
4"x12" . 10x30 cm

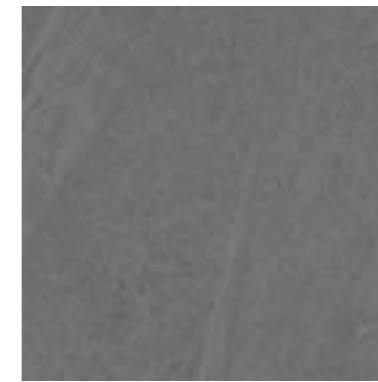

**G9EN08R**  
New England  
HEN08 Anthracite Rect.  
24"x24" . 60x60 cm



**G8EN08R**  
New England  
HEN08 Anthracite Rect.  
12"x24" . 30x60 cm



**G8EN08GRIP**  
New England  
HEN08 Anthracite **Grip** Rect.  
12"x24" . 30x60 cm



**G3EN05MO**  
New England  
HEN05 Cold Gray Mosaic\*  
1 3/8" x 1 3/8" . 3,5x3,5 cm  
(sheet 12"x12" . 30x30 cm)



**G3EN05HB**  
New England  
HEN05 Cold Gray Herringbone Mosaic\*  
1 7/8" x 3 7/8" . 4,7x9,7 cm  
(sheet 12"x14" . 31x35 cm)



**G3EN05BR**  
New England  
HEN05 Cold Gray Brick\*  
1 7/8" x 3 7/8" . 4,7x9,7 cm  
(sheet 12"x12" 30x30 cm)

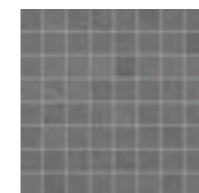

**G3EN08MO**  
New England  
HEN08 Anthracite Mosaic\*  
1 3/8" x 1 3/8" . 3,5x3,5 cm  
(sheet 12"x12" . 30x30 cm)



**G3EN08HB**  
New England  
HEN08 Anthracite Herringbone Mosaic\*  
1 7/8" x 3 7/8" . 4,7x9,7 cm  
(sheet 12"x14" . 31x35 cm)

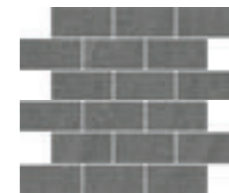

**G3EN08BR**  
New England  
HEN08 Anthracite Brick\*  
1 7/8" x 3 7/8" . 4,7x9,7 cm  
(sheet 12"x12" 30x30 cm)



**GOEN05**  
New England  
HEN05 Cold Gray Bullnose  
4"x24" . 10x60 cm



**GOEN08**  
New England  
HEN08 Anthracite Bullnose  
4"x24" . 10x60 cm

Stone Effect



# Verona

12"x24"



12"x24" . 30x60 cm

Glazed Porcelain Stoneware

ANSI A 137.1 compliant



WALL / FLOOR



LOW



0.34 in  
8.5 mm



ASTM C 1026  
RESISTANT



ASTM C 373  
~0.1%



ASTM C 650: CLASS A  
ASTM C 1378: CLASS A



ANSI A326.3: 2021.  
(DCOF): ≥0,42



MEDIUM USE

Pressed Collection

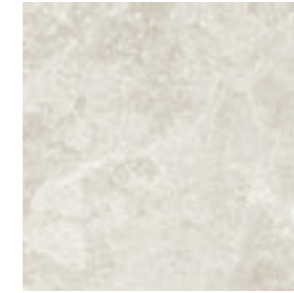

Verona  
VR10 Bianco



Verona  
VR01 Cream





Verona  
VR05 Gray

Graphics number

Sizes	Verona VR10 Bianco	Verona VR01 Cream	Verona VR05 Gray
12"x24"	32	32	32

Packaging

Sizes	Pieces					
		Sq.Ft.	Lbs.	Boxes	Sq.Ft.	Lbs.
12"x24"	8	15.50	61.40	32	497.28	1965.00
12"x12" mosaic	10	9.70	-	-	-	-
3"x12" bullnose	20	-	-	-	-	-



# Verona

12"x24"

VR

Stone Effect



108 Wall: Verona VR05 Gray 12"x24" - Verona VR05 Gray Mosaic 12"x12" (sheet) | Floor: Verona VR05 Gray 12"x24" - Verona VR05 Gray Mosaic 12"x12" (sheet)



Stone Effect

Wall: Verona VR05 Gray 12"x24" | Counter Top: Verona VR05 Gray Mosaic 12"x12" (sheet) 109



# Verona

12"x24"

VR

Stone Effect



Stone Effect





Wall: Verona VR01 Cream 12"x24" | Floor: Verona VR01 Cream 12"x24"

# Verona

12"x24"



**63VR10**  
Verona VR10 Bianco  
12"x24" . 30x60 cm

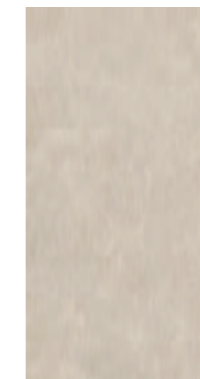

**63VR01**  
Verona VR01 Cream  
12"x24" . 30x60 cm



**63VR05**  
Verona VR05 Gray  
12"x24" . 30x60 cm



**32VR10MO**  
Verona VR10 Bianco Mosaic\*  
(sheet 12"x12" . 30x30 cm)



**32VR01MO**  
Verona VR01 Cream Mosaic\*  
(sheet 12"x12" . 30x30 cm)



**32VR05MO**  
Verona VR05 Gray Mosaic\*  
(sheet 12"x12" . 30x30 cm)



**13VR10**  
Verona VR10 Bianco Bullnose  
3"x12" . 8x30 cm



**13VR01**  
Verona VR01 Cream Bullnose  
3"x12" . 8x30 cm



**13VR05**  
Verona VR05 Gray Bullnose  
3"x12" . 8x30 cm

\*More details on page. 248-249





# Quartzite

24"x48" 12"x48" 12"x24" 4"x12" Rectified Collection

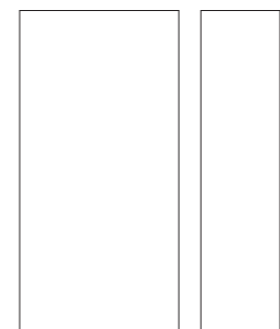

24"x48" . 60x120 cm 12"x48" . 30x120 cm



12"x24" . 30x60 cm 4"x12" . 10x30 cm

Colored Body Porcelain Stoneware

ANSI A 137.1 compliant



WALL / FLOOR



MODERATE



0.34 in  
8.5 mm



ASTM C 1026  
RESISTANT



ASTM C 373  
~0.1%



ASTM C 650: CLASS A  
ASTM C 1378: CLASS A



ANSI A326.3: 2021.  
(DCOF): ≥0,42  
Grip: (DCOF): ≥0,42



HEAVY USE



Quartzite  
HQT10 Bianco

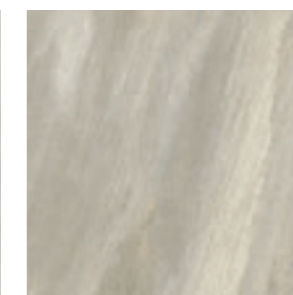

Quartzite  
HQT01 Sand



Quartzite  
HQT05 Gray

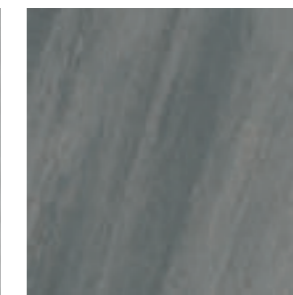

Quartzite  
HQT08 Dark Gray

### Graphics number

Sizes	Quartzite HQT10 Bianco	Quartzite HQT01 Sand	Quartzite HQT05 Gray	Quartzite HQT08 Dark Gray
24"x48"	8	8	8	8
12"x48"	16	16	16	16
12"x24"	32	32	32	32

### Packaging

Sizes	Pieces	Box		Pallet		
		Sq.Ft.	Lbs.	Boxes	Sq.Ft.	Lbs.
24"x48"	2	15.50	61.00	36	558.00	2236.00
12"x48"	3	11.62	45.75	54	627.75	2340.00
12"x24"	8	15.50	61.40	32	496.00	1932.48
4"x12"	36	11.65	46,45	40	466.00	1858.00
12"x12" mosaic	10	9.70	-	-	-	-
12"x12" muretto wall	10	9.70	-	-	-	-
4"x24" bullnose	10	-	-	-	-	-

## Quartzite 2

due2 Porcelain Pavers available



# Quartzite

24"x48" 12"x48" 12"x24" 4"x12"

HQT



Stone Effect

Stone Effect



# Quartzite

24"x48" 12"x48" 12"x24" 4"x12"

HQT



Stone Effect

Stone Effect



# Quartzite

24"x48" 12"x48" 12"x24" 4"x12"

Stone Effect

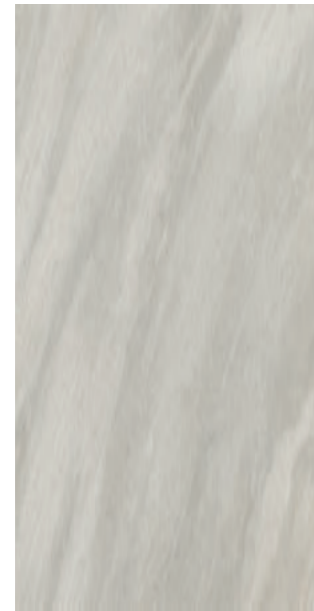

**GCQT10R**  
Quartzite HQT10 Bianco Rect.  
24"x48" . 60x120 cm



**GMQT10R**  
Quartzite HQT10 Bianco Rect.  
12"x48" . 30x120 cm

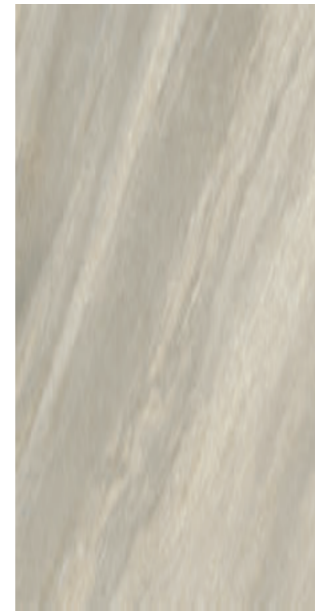

**GCQT01R**  
Quartzite HQT01 Sand Rect.  
24"x48" . 60x120 cm



**GMQT01R**  
Quartzite HQT01 Sand Rect.  
12"x48" . 30x120 cm



**GCQT05R**  
Quartzite HQT05 Gray Rect.  
24"x48" . 60x120 cm



**GMQT05R**  
Quartzite HQT05 Gray Rect.  
12"x48" . 30x120 cm

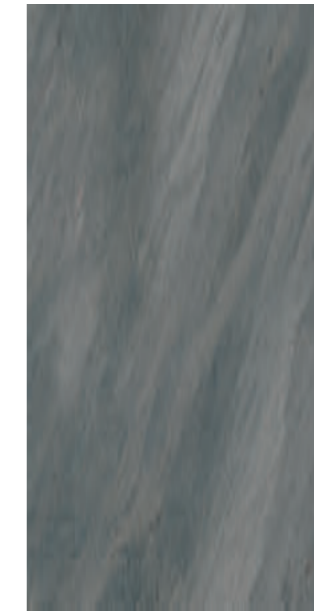

**GCQT08R**  
Quartzite HQT08 Dark Gray Rect.  
24"x48" . 60x120 cm



**GMQT08R**  
Quartzite HQT08 Dark Gray Rect.  
12"x48" . 30x120 cm



**G8QT10R**  
Quartzite HQT10 Bianco Rect.  
12"x24" . 30x60 cm



**30QT10**  
Quartzite HQT10 Bianco Rect.  
4"x12" . 10x30 cm



**G8QT01R**  
Quartzite HQT01 Sand Rect.  
12"x24" . 30x60 cm

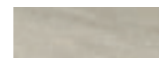

**30QT01**  
Quartzite HQT01 Sand Rect.  
4"x12" . 10x30 cm



**G8QT05R**  
Quartzite HQT05 Gray Rect.  
12"x24" . 30x60 cm



**30QT05**  
Quartzite HQT05 Gray Rect.  
4"x12" . 10x30 cm

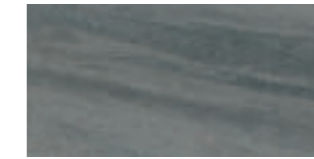

**G8QT08R**  
Quartzite HQT08 Dark Gray Rect.  
12"x24" . 30x60 cm



**30QT08**  
Quartzite HQT08 Dark Gray Rect.  
4"x12" . 10x30 cm

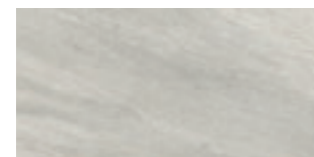

**G8QT10GRIR**  
Quartzite  
HQT10 Bianco **Grip** Rect.  
12"x24" . 30x60 cm



**G3QT10MO**  
Quartzite  
HQT10 Bianco Mosaic\*  
(sheet 12"x12" . 30x30 cm)

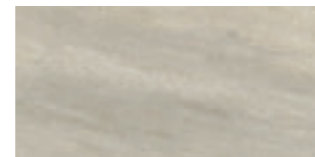

**G8QT01GRIR**  
Quartzite  
HQT01 Sand **Grip** Rect.  
12"x24" . 30x60 cm



**G3QT01MO**  
Quartzite  
HQT01 Sand Mosaic\*  
(sheet 12"x12" . 30x30 cm)



**G8QT05GRIR**  
Quartzite  
HQT05 Gray **Grip** Rect.  
12"x24" . 30x60 cm



**G3QT05MO**  
Quartzite  
HQT05 Gray Mosaic\*  
(sheet 12"x12" . 30x30 cm)

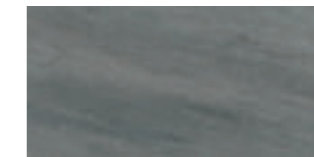

**G8QT08GRIR**  
Quartzite  
HQT08 Dark Gray **Grip** Rect.  
12"x24" . 30x60 cm

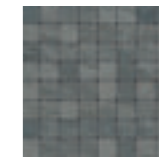

**G3QT08MO**  
Quartzite  
HQT08 Dark Gray Mosaic\*  
(sheet 12"x12" . 30x30 cm)



**G0QT10**  
Quartzite  
HQT10 Bianco Bullnose  
4"x24" . 10x60 cm



**G3QT10MU**  
Quartzite  
HQT10 Bianco Muretto Wall\*  
(sheet 12"x12" . 30x30 cm)



**G0QT01**  
Quartzite  
HQT01 Sand Bullnose  
4"x24" . 10x60 cm



**G3QT01MU**  
Quartzite  
HQT01 Sand Muretto Wall\*  
(sheet 12"x12" . 30x30 cm)



**G0QT05**  
Quartzite  
HQT05 Gray Bullnose  
4"x24" . 10x60 cm



**G3QT05MU**  
Quartzite  
HQT05 Gray Muretto Wall\*  
(sheet 12"x12" . 30x30 cm)



**G0QT08**  
Quartzite  
HQT08 Dark Gray Bullnose  
4"x24" . 10x60 cm



**G3QT08MU**  
Quartzite  
HQT08 Dark Gray Muretto Wall\*  
(sheet 12"x12" . 30x30 cm)

Stone Effect





# Navona

24"x48" 12"x48" 12"x24" 4"x12" Rectified Collection

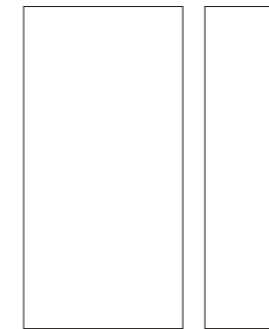

24"x48" . 60x120 cm 12"x48" . 30x120 cm



12"x24" . 30x60 cm 4"x12" . 10x30 cm

Glazed Porcelain Stoneware

ANSI A 137.1 compliant



WALL / FLOOR



MODERATE



0.34 in  
8.5 mm



ASTM C 1026  
RESISTANT



ASTM C 373  
~0.1%



ASTM C 650: CLASS A  
ASTM C 1378: CLASS A



ANSI A326.3: 2021.  
(DCOF): ≥0.42



MEDIUM USE



Navona  
NV10 Bianco

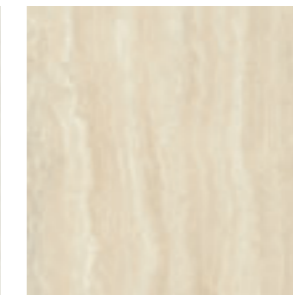

Navona  
NV01 Sabbia





Navona  
NV05 Grigio

## Graphics number

Sizes	Navona NV10 Bianco	Navona NV01 Sabbia	Navona NV05 Grigio
24"x48"	10	10	10
12"x48"	20	20	20
12"x24"	40	40	40

## Packaging

Sizes	Pieces					
		Sq.Ft.	Lbs.	Boxes	Sq.Ft.	Lbs.
24"x48"	2	15.50	61.00	36	558.00	2236.00
12"x48"	3	11.62	45.75	54	627.75	2340.00
12"x24"	8	15.50	61.40	32	496.00	1932.48
4"x12"	36	11.65	46,45	40	466.00	1858.00
12"x12" mosaic	10	9.70	-	-	-	-
12"x12" muretto wall	10	9.70	-	-	-	-
4"x24" bullnose	10	-	-	-	-	-



# Navona

24"x48" 12"x48" 12"x24" 4"x12"

NV



Stone Effect

Stone Effect



# Navona

24"x48" 12"x48" 12"x24" 4"x12"

NV



Stone Effect

Stone Effect



# Navona

24"x48" 12"x48" 12"x24" 4"x12"



**80NV10R**  
Navona NV10 Bianco Rect.  
24"x48" . 60x120 cm



**31NV10R**  
Navona NV10 Bianco Rect.  
12"x48" . 30x120 cm



**80NV01R**  
Navona NV01 Sabbia Rect.  
24"x48" . 60x120 cm



**31NV01R**  
Navona NV01 Sabbia Rect.  
12"x48" . 30x120 cm



**80NV05R**  
Navona NV05 Grigio Rect.  
24"x48" . 60x120 cm



**31NV05R**  
Navona NV05 Grigio Rect.  
12"x48" . 30x120 cm



**63NV10R**  
Navona NV10 Bianco Rect.  
12"x24" . 30x60 cm



**30NV10**  
Navona NV10 Bianco Rect.  
4"x12" . 10x30 cm



**63NV01R**  
Navona NV01 Sabbia Rect.  
12"x24" . 30x60 cm



**30NV01**  
Navona NV01 Sabbia Rect.  
4"x12" . 10x30 cm



**63NV05R**  
Navona NV05 Grigio Rect.  
12"x24" . 30x60 cm



**30NV05**  
Navona NV05 Grigio Rect.  
4"x12" . 10x30 cm



**32NV10MO**  
Navona NV10 Bianco Mosaic\*  
(sheet 12"x12" . 30x30 cm)



**32NV10MU**  
Navona NV10 Bianco Muretto Wall\*  
(sheet 12"x12" . 30x30 cm)



**32NV01MO**  
Navona NV01 Sabbia Mosaic\*  
(sheet 12"x12" . 30x30 cm)



**32NV01MU**  
Navona NV01 Sabbia Muretto Wall\*  
(sheet 12"x12" . 30x30 cm)



**32NV05MO**  
Navona NV05 Grigio Mosaic\*  
(sheet 12"x12" . 30x30 cm)



**32NV05MU**  
Navona NV05 Grigio Muretto Wall\*  
(sheet 12"x12" . 30x30 cm)



**13NV10**  
Navona NV10 Bianco Bullnose  
4"x24" . 10x60 cm



**13NV01**  
Navona NV01 Sabbia Bullnose  
4"x24" . 10x60 cm



**13NV05**  
Navona NV05 Grigio Bullnose  
4"x24" . 10x60 cm

Stone Effect

Stone Effect

NV



# Chamonix

24"x48" 24"x24" 12"x24"

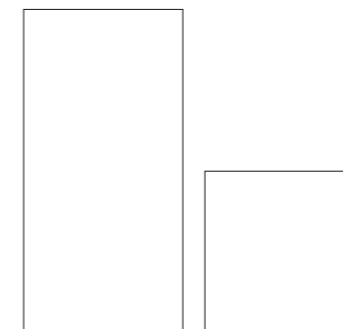

24"x48" . 60x120 cm 24"x24" . 60x60 cm



12"x24" . 30x60 cm

Colored Body Porcelain Stoneware

ANSI A 137.1 compliant



WALL / FLOOR



MODERATE



0.34 in  
8.5 mm



ASTM C 1026  
RESISTANT



ASTM C 373  
~0.1%



ASTM C 650: CLASS A  
ASTM C 1378: CLASS A



ANSI A326.3: 2021.  
(DCOF): ≥0,42



HEAVY USE

Rectified Collection

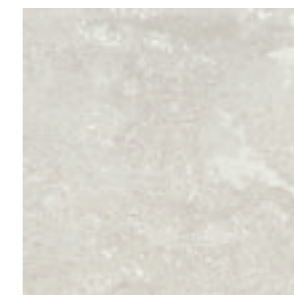

Chamonix  
HCX10 Bianco

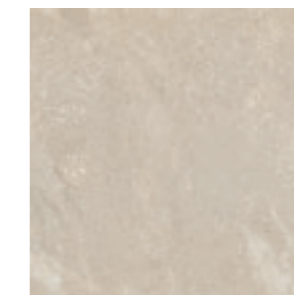

Chamonix  
HCX01 Beige

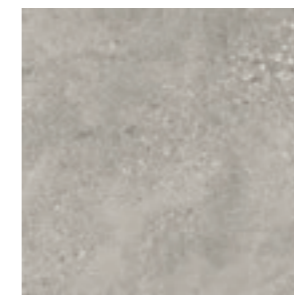

Chamonix  
HCX05 Gray

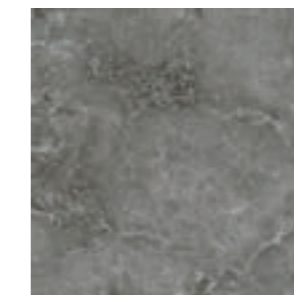

Chamonix  
HCX08 Dark Gray

Graphics number

Sizes	Chamonix HCX10 Bianco	Chamonix HCX01 Beige	Chamonix HCX05 Gray	Chamonix HCX08 Dark Gray
24"x48"	10	10	10	10
24"x24"	20	20	20	20
12"x24"	40	40	40	40

Packaging

Sizes	Pieces					
		Sq.Ft.	Lbs.	Boxes	Sq.Ft.	Lbs.
24"x48"	2	15.50	61.00	36	558.00	2236.00
24"x24"	6	23.25	91.50	24	558.00	2236.00
12"x24"	8	15.50	61.40	32	496.00	1932.48
12"x12" mosaic	10	9.70	-	-	-	-
10"x12" hexagon	10	8.40	-	-	-	-
12"x24" muretto brick	4	7.75	-	-	-	-
4"x24" bullnose	10	-	-	-	-	-

Chamonix **2**

due2 Porcelain Pavers available



Wall: Chamonix HCX01 Beige Hexagon 10"x12" (sheet)



# Chamonix

24"x48" 24"x24" 12"x24"



Stone Effect

Stone Effect



# Chamonix

24"x48" 24"x24" 12"x24"

HCX

Stone Effect



134 Floor: Chamonix HCX05 Gray Rect. 12"x24"



Stone Effect

Wall: Chamonix HCX01 Beige Rect. 12"x24" 135



# Chamonix

24"x48" 24"x24" 12"x24"

Stone Effect



**GCCX10R**  
Chamonix HCX10 Bianco Rect.  
24"x48" . 60x120 cm



**G8CX10R**  
Chamonix HCX10 Bianco Rect.  
12"x24" . 30x60 cm



**G9CX10R**  
Chamonix HCX10 Bianco Rect.  
24"x24" . 60x60 cm

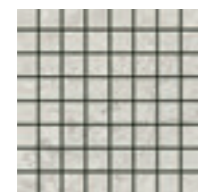

**G3CX10MO**  
Chamonix HCX10 Bianco Mosaic\*  
(sheet 12"x12" . 30x30 cm)



**G3CX10HEX1**  
Chamonix HCX10 Bianco Hexagon\*  
(sheet 10"x12" 26x30 cm)



**G8CX10MU**  
Chamonix HCX10 Bianco Muretto Brick\*  
12"x24" . 30x60 cm



**G0CX10**  
Chamonix HCX10 Bianco Bullnose  
4"x24" . 10x60 cm

\*More details on page. 248-249

Stone Effect



**GCCX01R**  
Chamonix HCX01 Beige Rect.  
24"x48" . 60x120 cm

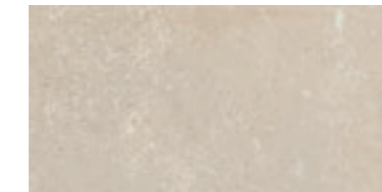

**G8CX01R**  
Chamonix HCX01 Beige Rect.  
12"x24" . 30x60 cm



**G9CX01R**  
Chamonix HCX01 Beige Rect.  
24"x24" . 60x60 cm



**G3CX01MO**  
Chamonix HCX01 Beige Mosaic\*  
(sheet 12"x12" . 30x30 cm)



**G3CX01HEX1**  
Chamonix HCX01 Beige Hexagon\*  
(sheet 10"x12" 26x30 cm)

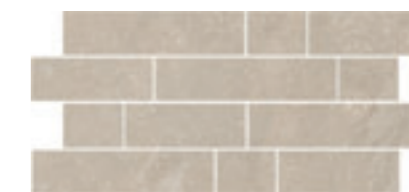

**G8CX01MU**  
Chamonix HCX01 Beige Muretto Brick\*  
12"x24" . 30x60 cm



**G0CX01**  
Chamonix HCX01 Beige Bullnose  
4"x24" . 10x60 cm

\*More details on page. 248-249



# Chamonix

24"x48" 24"x24" 12"x24"

Stone Effect



**GCCX05R**  
Chamonix HCX05 Gray Rect.  
24"x48" . 60x120 cm



**G8CX05R**  
Chamonix HCX05 Gray Rect.  
12"x24" . 30x60 cm



**G9CX05R**  
Chamonix HCX05 Gray Rect.  
24"x24" . 60x60 cm



**G3CX05MO**  
Chamonix HCX05 Gray Mosaic\*  
(sheet 12"x12" . 30x30 cm)



**G3CX05HEX1**  
Chamonix HCX05 Gray Hexagon\*  
(sheet 10"x12" 26x30 cm)

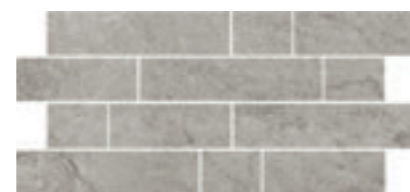

**G8CX05MU**  
Chamonix HCX05 Gray Muretto Brick\*  
12"x24" . 30x60 cm



**G0CX05**  
Chamonix HCX05 Gray Bullnose  
4"x24" . 10x60 cm

Stone Effect

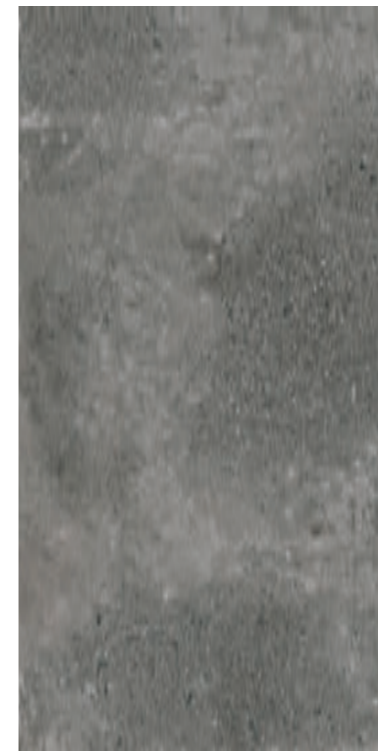

**GCCX08R**  
Chamonix HCX08 Dark Gray Rect.  
24"x48" . 60x120 cm



**G8CX08R**  
Chamonix HCX08 Dark Gray Rect.  
12"x24" . 30x60 cm

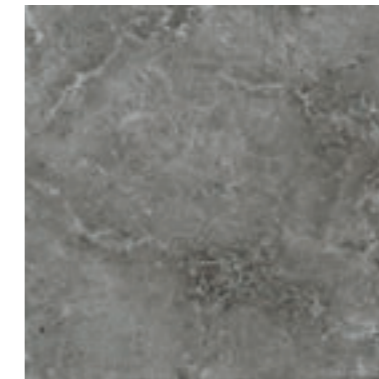

**G9CX08R**  
Chamonix HCX08 Dark Gray Rect.  
24"x24" . 60x60 cm



**G3CX08MO**  
Chamonix HCX08 Dark Gray Mosaic\*  
(sheet 12"x12" . 30x30 cm)

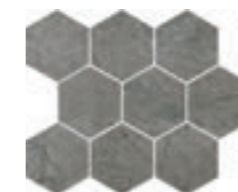

**G3CX08HEX1**  
Chamonix HCX08 Dark Gray Hexagon\*  
(sheet 10"x12" 26x30 cm)



**G8CX08MU**  
Chamonix HCX08 Dark Gray Muretto Brick\*  
12"x24" . 30x60 cm



**G0CX08**  
Chamonix HCX08 Dark Gray Bullnose  
4"x24" . 10x60 cm





# West 57th

12"x24"



12"x24" . 30x60 cm

Colored Body Porcelain Stoneware

ANSI A 137.1 compliant



WALL / FLOOR



MODERATE



0.34 in  
8.5 mm



ASTM C 1026  
RESISTANT



ASTM C 373  
~0.1%



ASTM C 650: CLASS A  
ASTM C 1378: CLASS A



ANSI A326.3: 2021.  
(DCOF): ≥0,42



HEAVY USE

Pressed Collection



West 57th  
HWS10 Bianco

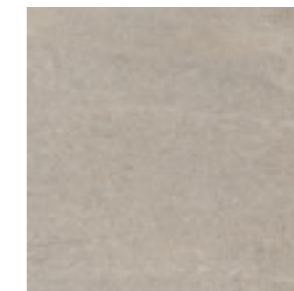

West 57th  
HWS01 Beige



West 57th  
HWS05 Gray

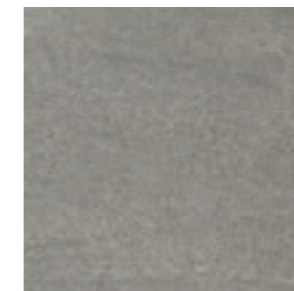

West 57th  
HWS13 Moka

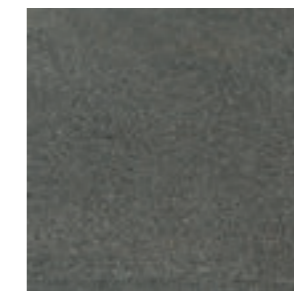

West 57th  
HWS08 Nero

Graphics number

Sizes	West 57th HWS10 Bianco	West 57th HWS01 Beige	West 57th HWS05 Gray	West 57th HWS13 Moka	West 57th HWS08 Nero
12"x24"	38	48	48	48	48

Packaging

Sizes	Pieces	Box		Pallet		
		Sq.Ft.	Lbs.	Boxes	Sq.Ft.	Lbs.
12"x24"	8	15.54	61.40	32	497.28	1965.00
12"x12" mosaic	10	9.70	36.00	-	-	-
12"x24" muretto	4	7.75	29.73	-	-	-
3"x24" bullnose	10	-	-	-	-	-

## West 57th

due2 Porcelain Pavers available  
in Bianco, Gray



# West 57th

12"x24"



Stone Effect

Stone Effect





Floor: West 57th HWS13 Moka 12"x24"

# West 57th

12"x24"

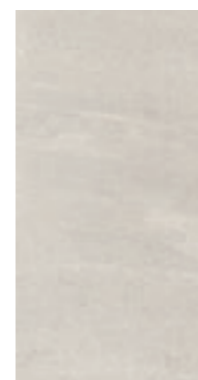

**G8WS10**  
West 57th HWS10 Bianco  
12"x24" . 30x60 cm

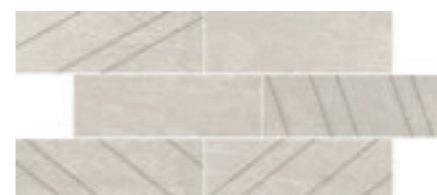

**G8WS10MU**  
West 57th HWS10 Bianco Muretto\*  
12"x24" . 30x60 cm



**G3WS10MO**  
West 57th HWS10 Bianco Mosaic\*  
(sheet 12"x12" . 30x30 cm)



**G0WS10**  
West 57th HWS10 Bianco Bullnose  
3"x24" . 7,5x60 cm



\*More details on page. 248-249



# West 57th

12"x24"

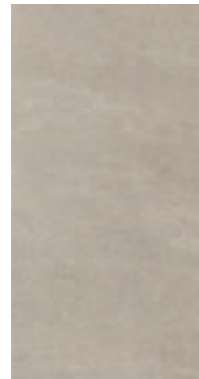

**G8WS01**  
West 57th HWS01 Beige  
12"x24" . 30x60 cm

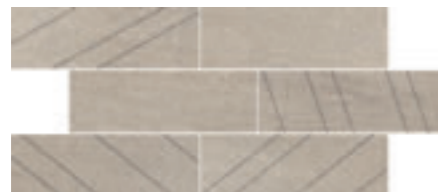

**G8WS01MU**  
West 57th HWS01 Beige Muretto\*  
12"x24" . 30x60 cm



**G3WS01MO**  
West 57th HWS01 Beige Mosaic\*  
(sheet 12"x12" . 30x30 cm)



**G0WS01**  
West 57th HWS01 Beige Bullnose  
3"x24" . 7,5x60 cm

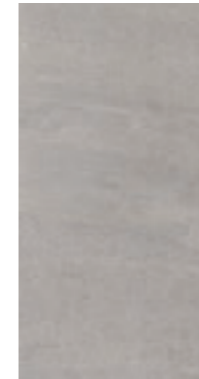
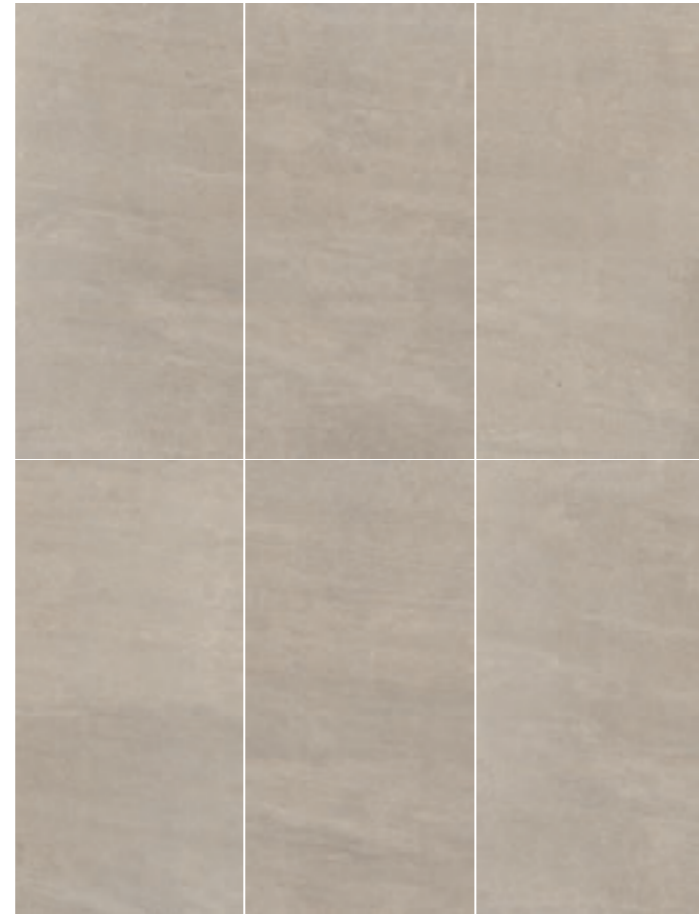

**G8WS05**  
West 57th HWS05 Gray  
12"x24" . 30x60 cm

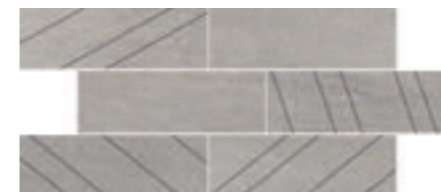

**G8WS05MU**  
West 57th HWS05 Gray Muretto\*  
12"x24" . 30x60 cm



**G3WS05MO**  
West 57th HWS05 Gray Mosaic\*  
(sheet 12"x12" . 30x30 cm)



**G0WS05**  
West 57th HWS05 Gray Bullnose  
3"x24" . 7,5x60 cm



Stone Effect

Stone Effect



# West 57th

12"x24"

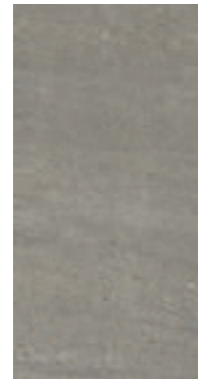

**G8WS13**  
West 57th HWS13 Moka  
12"x24" . 30x60 cm

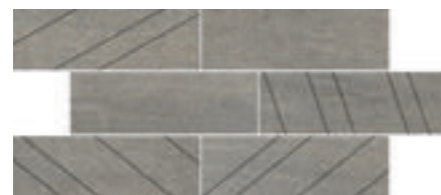

**G8WS13MU**  
West 57th HWS13 Moka Muretto\*  
12"x24" . 30x60 cm



**G3WS13MO**  
West 57th HWS13 Moka Mosaic\*  
(sheet 12"x12" . 30x30 cm)



**G0WS13**  
West 57th HWS13 Moka Bullnose  
3"x24" . 7,5x60 cm

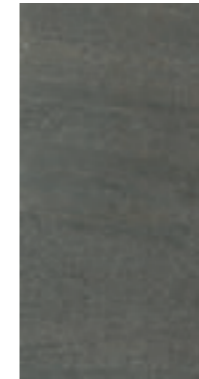
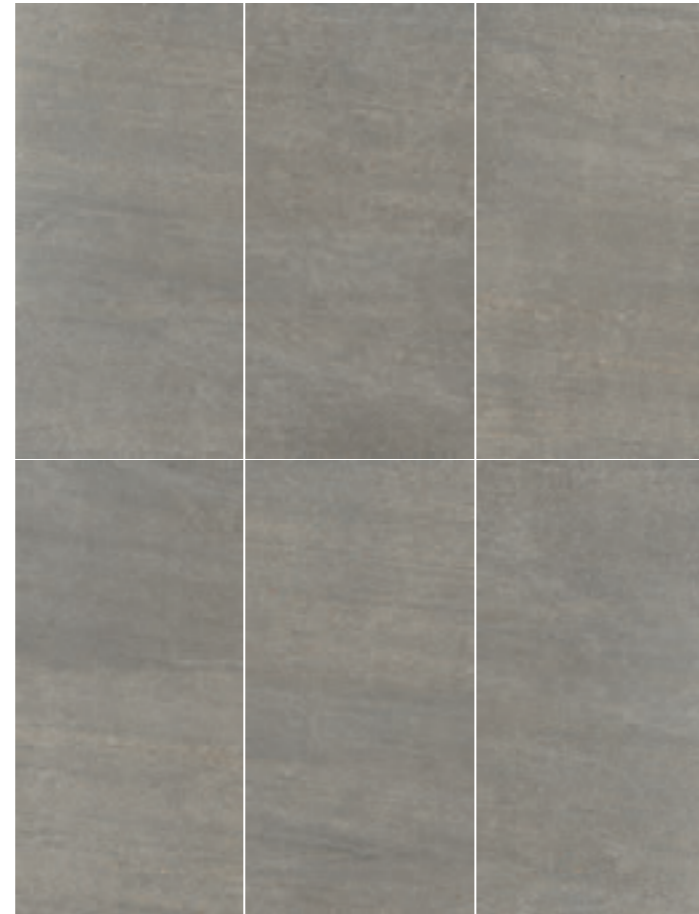

**G8WS08**  
West 57th HWS08 Nero  
12"x24" . 30x60 cm



**G8WS08MU**  
West 57th HWS08 Nero Muretto\*  
12"x24" . 30x60 cm



**G3WS08MO**  
West 57th HWS08 Nero Mosaic\*  
(sheet 12"x12" . 30x30 cm)



**G0WS08**  
West 57th HWS08 Nero Bullnose  
3"x24" . 7,5x60 cm

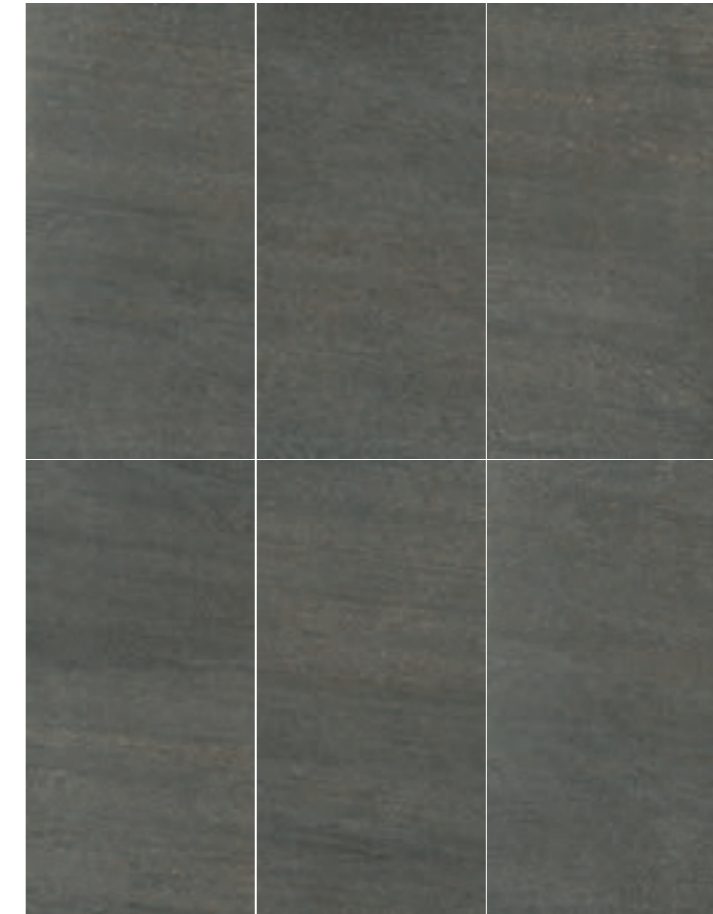

Stone Effect

Stone Effect





# Neopolis

12"x24" 4"x12"



12"x24" . 30x60 cm



4"x12" . 10x30 cm

Glazed Porcelain Stoneware

ANSI A 137.1 compliant



WALL / FLOOR



MODERATE



0.28 in  
7 mm



ASTM C 1026  
RESISTANT



ASTM C 373  
~0.1%



ASTM C 650: CLASS A  
ASTM C 1378: CLASS A



ANSI A326.3: 2021.  
(DCOF): ≥0,42



MEDIUM USE

12"x24" Pressed - 4"x12" Rectified



Neopolis  
NE10 Bianco

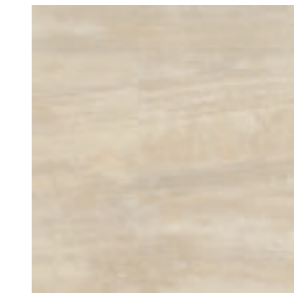

Neopolis  
NE01 Beige

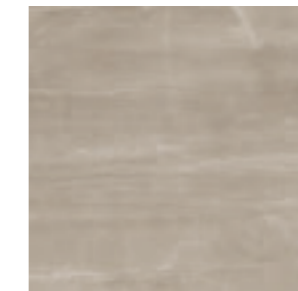

Neopolis  
NE13 Moka





Neopolis  
NE05 Gray

## Graphics number

Sizes	Neopolis NE10 Bianco	Neopolis NE01 Beige	Neopolis NE13 Moka	Neopolis NE05 Gray
12"x24"	36	35	35	30

## Packaging

Sizes	Pieces					
		Sq.Ft.	Lbs.	Boxes	Sq.Ft.	Lbs.
12"x24"	9	17.44	60.39	32	557.98	1932.48
4"x12"	36	11.65	40.55	36	419.00	1459.80
12"x12" mosaic	10	9.70	35.82	-	-	-
12"x14" capri mosaic	6	6.78	21.60	-	-	-
3"x12" bullnose	20	-	-	-	-	-



# Neopolis

12"x24" 4"x12"

NE

Stone Effect



Stone Effect





# Neopolis

12"x24" 4"x12"

Stone Effect



**63NE10**  
Neopolis NE10 Bianco  
12"x24" . 30x60 cm



**30NE10**  
Neopolis NE10 Bianco Rect.  
4"x12" . 10x30 cm



**63NE01**  
Neopolis NE01 Beige  
12"x24" . 30x60 cm



**30NE01**  
Neopolis NE01 Beige Rect.  
4"x12" . 10x30 cm



**63NE13**  
Neopolis NE13 Moka  
12"x24" . 30x60 cm



**30NE13**  
Neopolis NE13 Moka Rect.  
4"x12" . 10x30 cm



**63NE05**  
Neopolis NE05 Gray  
12"x24" . 30x60 cm



**30NE05**  
Neopolis NE05 Gray Rect.  
4"x12" . 10x30 cm



**32NE10MO**  
Neopolis NE10 Bianco Mosaic\*  
(sheet 12"x12" . 30x30 cm)



**32NE10MO1**  
Neopolis  
NE10 Bianco Capri Mosaic\*  
(sheet 12"x14" . 30x36 cm)



**32NE01MO**  
Neopolis NE01 Beige Mosaic\*  
(sheet 12"x12" . 30x30 cm)

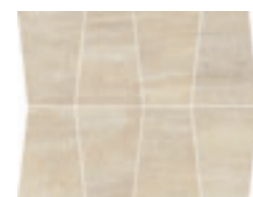

**32NE01MO1**  
Neopolis  
NE01 Beige Capri Mosaic\*  
(sheet 12"x14" . 30x36 cm)

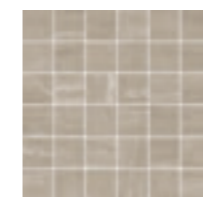

**32NE13MO**  
Neopolis NE13 Moka Mosaic\*  
(sheet 12"x12" . 30x30 cm)



**32NE13MO1**  
Neopolis  
NE13 Moka Capri Mosaic\*  
(sheet 12"x14" . 30x36 cm)

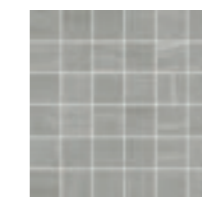

**32NE05MO**  
Neopolis NE05 Gray Mosaic\*  
(sheet 12"x12" . 30x30 cm)



**32NE05MO1**  
Neopolis  
NE05 Gray Capri Mosaic\*  
(sheet 12"x14" . 30x36 cm)



**13NE10**  
Neopolis NE10 Bianco Bullnose  
3"x12" . 8x30 cm



**13NE01**  
Neopolis NE01 Beige Bullnose  
3"x12" . 8x30 cm



**13NE13**  
Neopolis NE13 Moka Bullnose  
3"x12" . 8x30 cm



**13NE05**  
Neopolis NE05 Gray Bullnose  
3"x12" . 8x30 cm

Stone Effect





# Gotham

12"x24"



12"x24" . 30x60 cm

Glazed Porcelain Stoneware

ANSI A 137.1 compliant



WALL / FLOOR



RANDOM



0.34 in  
8.5 mm



ASTM C 1026  
RESISTANT



ASTM C 373  
~0.1%



ASTM C 650: CLASS A  
ASTM C 1378: CLASS A



ANSI A326.3: 2021.  
(DCOF): ≥0,42



MEDIUM USE

## Gotham 2

due2 Porcelain Pavers available  
in Bianco, Gray, Nero

Pressed Collection



Gotham  
GO10 Bianco



Gotham  
GO05 Gray



Gotham  
GO01 Beige



Gotham  
GO08 Nero

Graphics number

Sizes	Gotham GO10 Bianco	Gotham GO05 Gray	Gotham GO01 Beige	Gotham GO08 Nero
12"x24"	39	42	36	48

Packaging

Sizes	Pieces					
		Sq.Ft.	Lbs.	Boxes	Sq.Ft.	Lbs.
12"x24"	8	15.54	61.40	32	497.28	1965.00
12"x12" mosaic	10	9.70	35.82	-	-	-
12"x12" intreccio	10	9.70	35.82	-	-	-
3"x12" bullnose	20	-	-	-	-	-



# Gotham

12"x24"

Stone Effect



Stone Effect



# Gotham

12"x24"

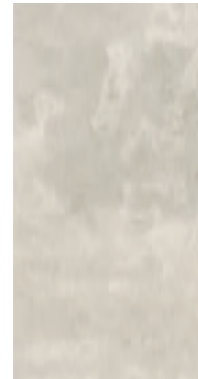

**63GO10**  
Gotham GO10 Bianco  
12"x24" . 30x60 cm

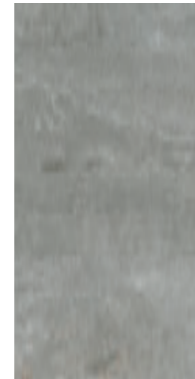

**63GO05**  
Gotham GO05 Gray  
12"x24" . 30x60 cm



**63GO01**  
Gotham GO01 Beige  
12"x24" . 30x60 cm

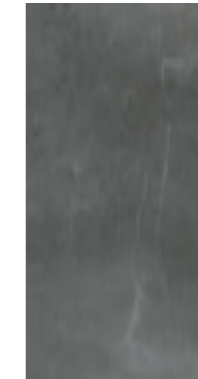

**63GO08**  
Gotham GO08 Nero  
12"x24" . 30x60 cm



**32GO10MO**  
Gotham GO10 Bianco Mosaic\*  
(sheet 12"x12" . 30x30 cm)



**32GO10IN**  
Gotham GO10 Bianco Intreccio\*  
(sheet 12"x12" . 30x30 cm)

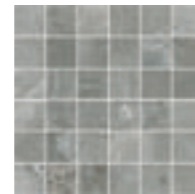

**32GO05MO**  
Gotham GO05 Gray Mosaic\*  
(sheet 12"x12" . 30x30 cm)



**32GO05IN**  
Gotham GO05 Gray Intreccio\*  
(sheet 12"x12" . 30x30 cm)

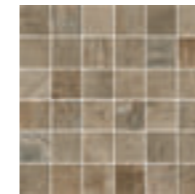

**32GO01MO**  
Gotham GO01 Beige Mosaic\*  
(sheet 12"x12" . 30x30 cm)

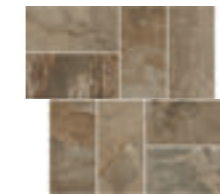

**32GO01IN**  
Gotham GO01 Beige Intreccio\*  
(sheet 12"x12" . 30x30 cm)

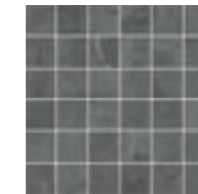

**32GO08MO**  
Gotham GO08 Nero Mosaic\*  
(sheet 12"x12" . 30x30 cm)



**32GO08IN**  
Gotham GO08 Nero Intreccio\*  
(sheet 12"x12" . 30x30 cm)



**13GO10**  
Gotham GO10 Bianco Bullnose  
3"x12" . 8x30 cm



**13GO05**  
Gotham GO05 Gray Bullnose  
3"x12" . 8x30 cm



**13GO01**  
Gotham GO01 Beige Bullnose  
3"x12" . 8x30 cm



**13GO08**  
Gotham GO08 Nero Bullnose  
3"x12" . 8x30 cm

Stone Effect

Stone Effect

GO



# Marble Effect

Nature 164





# Nature

24"x48" 24"x24" 12"x24" 4"x12" Rectified Collection

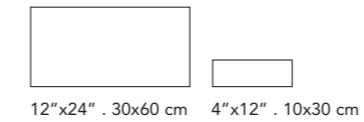
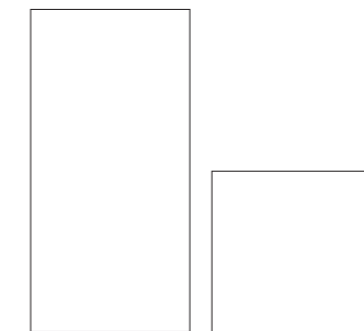

Colored Body Porcelain Stoneware

ANSI A 137.1 compliant

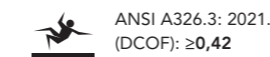
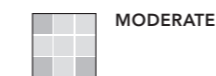

Nature  
NA07 Calacatta Gold



Nature  
NA10 Statuario Bianco

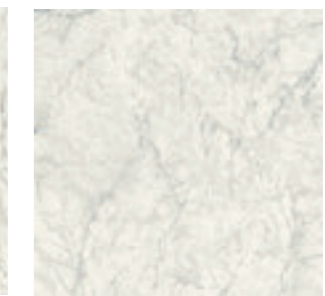

Nature  
NA20 Carrara

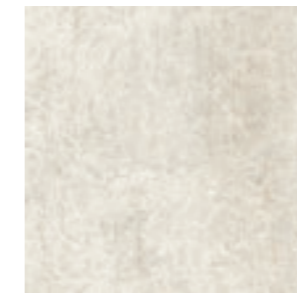

Nature  
NA01 Taj Mahal

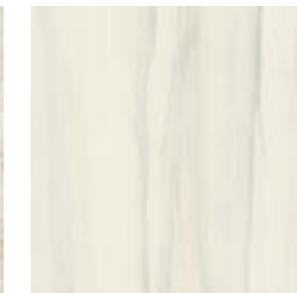

Nature  
NA05 Dolomite

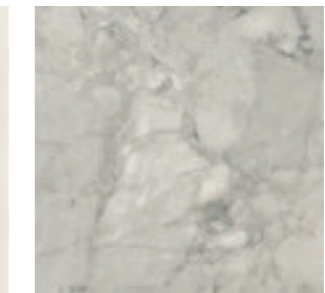

Nature  
NA25 Calacatta Vagli

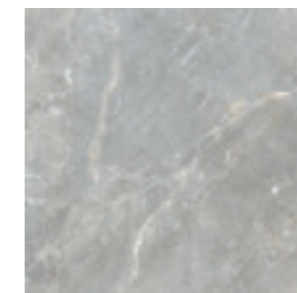

Nature  
NA02 Fior di Bosco

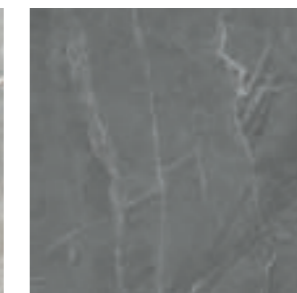

Nature  
NA15 Belvedere

### Graphics number

Sizes	Nature NA07 Calacatta Gold	Nature NA10 Statuario Bianco	Nature NA20 Carrara	Nature NA01 Taj Mahal	Nature NA05 Dolomite	Nature NA25 Calacatta Vagli	Nature NA02 Fior di Bosco	Nature NA15 Belvedere
24"x48"	14	14	8	10	8	10	10	10
24"x24"	28	28	16	20	16	20	20	20
12"x24"	56	56	32	40	32	40	40	40

### Packaging

Sizes	Pieces	Pieces		Boxes	Boxes	
		Sq.Ft.	Lbs.		Sq.Ft.	Lbs.
24"x48"	2	15.50	61.00	36	558.00	2236.00
24"x24"	6	23.25	91.50	24	558.00	2236.00
12"x24"	8	15.50	61.40	32	496.00	1932.48
4"x12"	36	11.65	46,45	40	466.00	1858.00
12"x12"	mosaic	10	9.70	-	-	-
10"x12"	hexagon	10	8.40	-	-	-
4"x24"	bullnose	10	-	-	-	-

## Nature 2

due2 Porcelain Pavers available  
in Carrara, Dolomite



# Nature

24"x48" 24"x24" 12"x24" 4"x12"

NA

Marble Effect



Marble Effect



# Nature

24"x48" 24"x24" 12"x24" 4"x12"

NA

Marble Effect



168 Wall: Nature NA07 Calacatta Gold Hexagon 10"x12"



Marble Effect

Floor: Nature NA07 Calacatta Gold Rect. 24"x48" 169



# Nature

24"x48" 24"x24" 12"x24" 4"x12"

NA



Marble Effect

Marble Effect



# Nature

24"x48" 24"x24" 12"x24" 4"x12"

NA

Marble Effect



172 Wall: Nature NA01 Taj Mahal Rect. 24"x48" | Floor: Nature NA01 Taj Mahal Rect. 24"x48"



Marble Effect

Wall: Nature NA01 Taj Mahal Rect. 24"x48" - Nature NA01 Taj Mahal Hexagon 10"x12" | Floor: Nature NA01 Taj Mahal Rect. 24"x48" 173



# Nature

24"x48" 24"x24" 12"x24" 4"x12"

NA



Marble Effect

Marble Effect



# Nature

24"x48" 24"x24" 12"x24" 4"x12"

Marble Effect



176 Wall: Nature NA05 Dolomite Rect. 4"x12" | Floor: Nature NA05 Dolomite Rect. 24"x24"



Marble Effect

Wall: Nature NA05 Dolomite Rect. 12"x24" | Floor: Nature NA05 Dolomite Rect. 12"x24" 177



# Nature

24"x48" 24"x24" 12"x24" 4"x12"

NA



Marble Effect

Marble Effect

Indoor & Outdoor living spaces ideas



# Nature

24"x48" 24"x24" 12"x24" 4"x12"

NA



Marble Effect

Marble Effect



# Nature

24"x48" 24"x24" 12"x24" 4"x12"

NA

Marble Effect



Marble Effect



# Nature

24"x48" 24"x24" 12"x24" 4"x12"

NA



Marble Effect

Marble Effect



# Nature

24"x48" 24"x24" 12"x24" 4"x12"



Marble Effect

Marble Effect

Indoor & Outdoor living spaces ideas



# Nature

24"x48" 24"x24" 12"x24" 4"x12"

NA



Marble Effect

Marble Effect



# Nature

24"x48" 24"x24" 12"x24" 4"x12"

NA

Marble Effect



Marble Effect



# Nature

24"x48" 24"x24" 12"x24" 4"x12"

NA

Marble Effect



Marble Effect



# Nature

24"x48" 24"x24" 12"x24" 4"x12"

NA

Marble Effect



194 Wall: Nature NA10 Statuario Bianco Rect. 24"x48" | Seat: Nature NA10 Statuario Bianco Mosaic 12"x12" (sheet)



Marble Effect

Floor: Nature NA10 Statuario Bianco Rect. 24"x24" 195



# Nature

24"x48" 24"x24" 12"x24" 4"x12"

NA

Marble Effect



Marble Effect



# Nature

24"x48" 24"x24" 12"x24" 4"x12"

Marble Effect

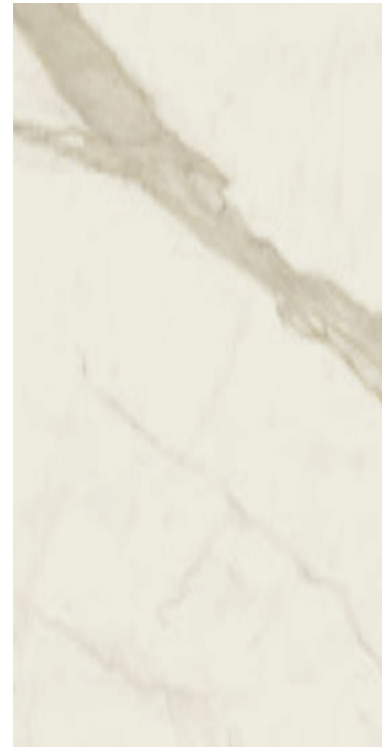

**80NA07R**  
Nature NA07 Calacatta Gold Rect.  
24"x48" . 60x120 cm

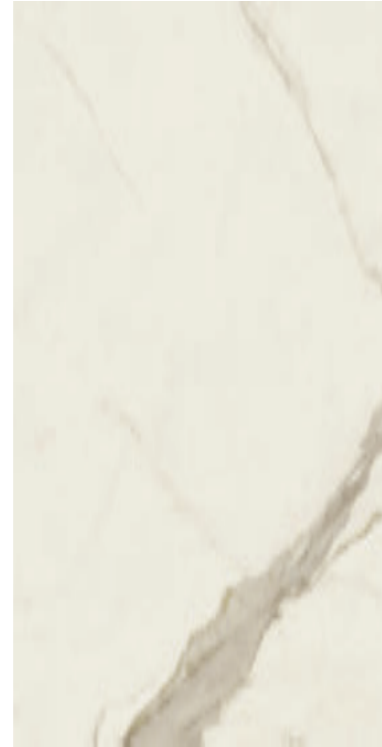

**80NA07S** **MADE IN ITALY**  
Nature NA07 Calacatta Gold **Polished** Rect.  
24"x48" . 60x120 cm



**30NA07**  
Nature NA07 Calacatta Gold Rect.  
4"x12" . 10x30 cm

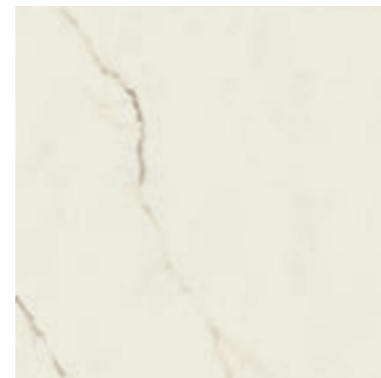

**60NA07R**  
Nature NA07 Calacatta Gold Rect.  
24"x24" . 60x60 cm

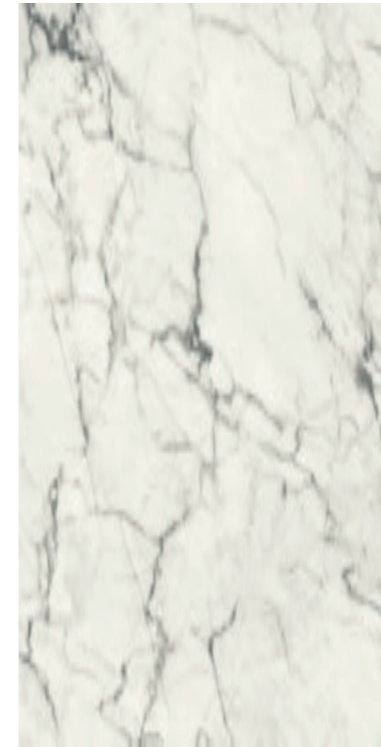

**80NA10R**  
Nature NA10 Statuario Bianco Rect.  
24"x48" . 60x120 cm



**30NA10**  
Nature NA10 Statuario Bianco Rect.  
4"x12" . 10x30 cm

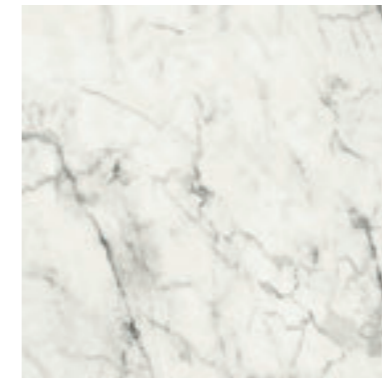

**60NA10R**  
Nature NA10 Statuario Bianco Rect.  
24"x24" . 60x60 cm

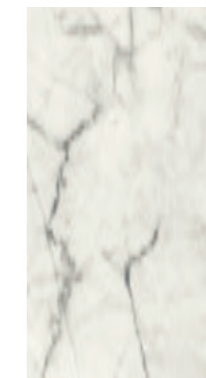

**63NA10R**  
Nature NA10 Statuario Bianco Rect.  
12"x24" . 30x60 cm



**63NA07R**  
Nature NA07 Calacatta Gold Rect.  
12"x24" . 30x60 cm



**32NA07MO**  
Nature NA07 Calacatta Gold Mosaic\*  
(sheet 12"x12" . 30x30 cm)



**32NA07HEX1**  
Nature NA07 Calacatta Gold Hexagon\*  
(sheet 10"x12" . 26x30 cm)



**13NA07**  
Nature NA07 Calacatta Gold Bullnose  
4"x24" . 10x60 cm



**32NA10MO**  
Nature NA10 Statuario Bianco Mosaic\*  
(sheet 12"x12" . 30x30 cm)

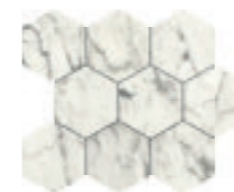

**32NA10HEX1**  
Nature NA10 Statuario Bianco Hexagon\*  
(sheet 10"x12" . 26x30 cm)



**13NA10**  
Nature NA10 Statuario Bianco Bullnose  
4"x24" . 10x60 cm

Marble Effect



# Nature

24"x48" 24"x24" 12"x24" 4"x12"

Marble Effect

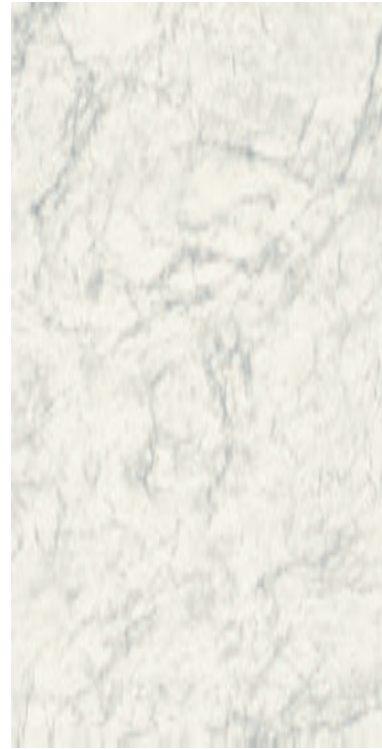

**80NA20R**  
Nature NA20 Carrara Rect.  
24"x48" . 60x120 cm

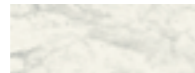

**30NA20**  
Nature NA20 Carrara Rect.  
4"x12" . 10x30 cm

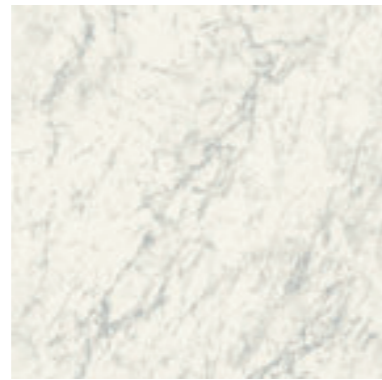

**60NA20R**  
Nature NA20 Carrara Rect.  
24"x24" . 60x60 cm

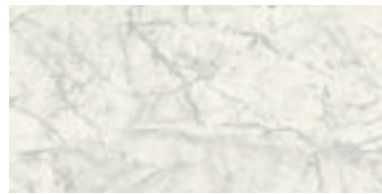

**63NA20R**  
Nature NA20 Carrara Rect.  
12"x24" . 30x60 cm

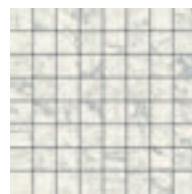

**32NA20MO**  
Nature NA20 Carrara Mosaic\*  
(sheet 12"x12" . 30x30 cm)

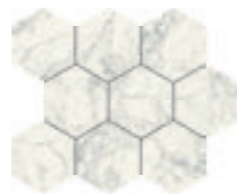

**32NA20HEX1**  
Nature NA20 Carrara Hexagon\*  
(sheet 10"x12" . 26x30 cm)



**13NA20**  
Nature NA20 Carrara Bullnose  
4"x24" . 10x60 cm



**80NA01R**  
Nature NA01 Taj Mahal Rect.  
24"x48" . 60x120 cm



**80NA01S** **MADE IN ITALY**  
Nature NA01 Taj Mahal **Polished** Rect.  
24"x48" . 60x120 cm



**30NA01**  
Nature NA01 Taj Mahal Rect.  
4"x12" . 10x30 cm



**60NA01R**  
Nature NA01 Taj Mahal Rect.  
24"x24" . 60x60 cm



**63NA01R**  
Nature NA01 Taj Mahal Rect.  
12"x24" . 30x60 cm



**32NA01MO**  
Nature NA01 Taj Mahal Mosaic\*  
(sheet 12"x12" . 30x30 cm)



**32NA01HEX1**  
Nature NA01 Taj Mahal Hexagon\*  
(sheet 10"x12" . 26x30 cm)



**13NA01**  
Nature NA01 Taj Mahal Bullnose  
4"x24" . 10x60 cm

Marble Effect



# Nature

24"x48" 24"x24" 12"x24" 4"x12"

Marble Effect



**80NA05R**  
Nature NA05 Dolomite Rect.  
24"x48" . 60x120 cm



**80NA05S** **MADE IN ITALY**  
Nature NA05 Dolomite Polished Rect.  
24"x48" . 60x120 cm

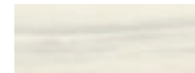

**30NA05**  
Nature NA05 Dolomite Rect.  
4"x12" . 10x30 cm



**60NA05R**  
Nature NA05 Dolomite Rect.  
24"x24" . 60x60 cm

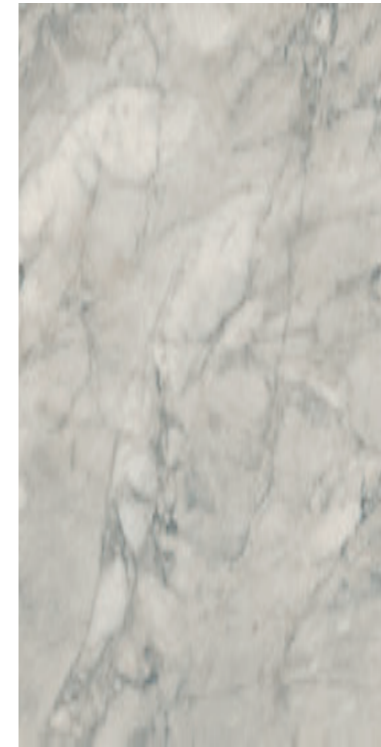

**80NA25R**  
Nature NA25 Calacatta Vagli Rect.  
24"x48" . 60x120 cm

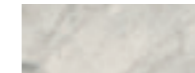

**30NA25**  
Nature NA25 Calacatta Vagli Rect.  
4"x12" . 10x30 cm

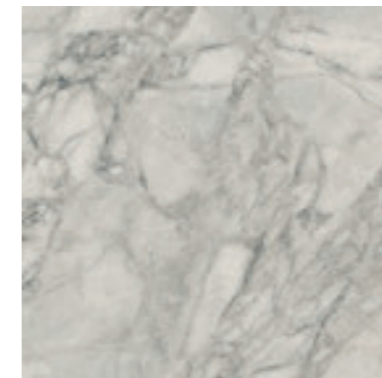

**60NA25R**  
Nature NA25 Calacatta Vagli Rect.  
24"x24" . 60x60 cm



**63NA05R**  
Nature NA05 Dolomite Rect.  
12"x24" . 30x60 cm

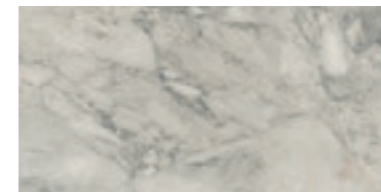

**63NA25R**  
Nature NA25 Calacatta Vagli Rect.  
12"x24" . 30x60 cm



**32NA05MO**  
Nature NA05 Dolomite Mosaic\*  
(sheet 12"x12" . 30x30 cm)



**32NA05HEX1**  
Nature NA05 Dolomite Hexagon\*  
(sheet 10"x12" . 26x30 cm)



**13NA05**  
Nature NA05 Dolomite Bullnose\*  
4"x24" . 10x60 cm



**32NA25MO**  
Nature NA25 Calacatta Vagli Mosaic\*  
(sheet 12"x12" . 30x30 cm)



**32NA25HEX1**  
Nature NA25 Calacatta Vagli Hexagon\*  
(sheet 10"x12" . 26x30 cm)



**13NA25**  
Nature NA25 Calacatta Vagli Bullnose\*  
4"x24" . 10x60 cm

Marble Effect

NA



# Nature

24"x48" 24"x24" 12"x24" 4"x12"

Marble Effect

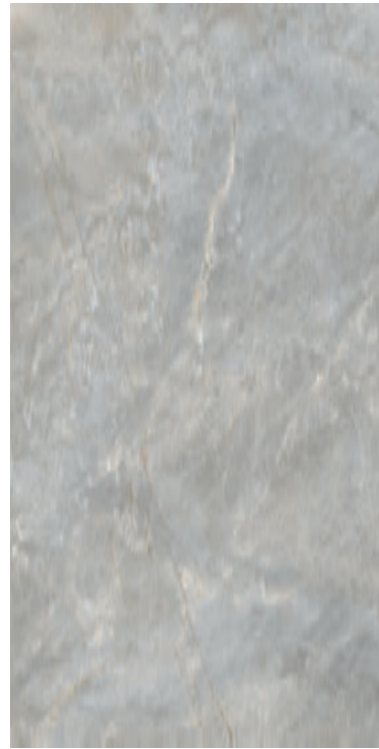

**80NA02R**  
Nature NA02 Fior di Bosco Rect.  
24"x48" . 60x120 cm



**30NA02**  
Nature NA02 Fior di Bosco Rect.  
4"x12" . 10x30 cm



**60NA02R**  
Nature NA02 Fior di Bosco Rect.  
24"x24" . 60x60 cm



**63NA02R**  
Nature NA02 Fior di Bosco Rect.  
12"x24" . 30x60 cm



**32NA02MO**  
Nature NA02 Fior di Bosco Mosaic\*  
(sheet 12"x12" . 30x30 cm)



**32NA02HEX1**  
Nature NA02 Fior di Bosco Hexagon\*  
(sheet 10"x12" . 26x30 cm)



**13NA02**  
Nature NA02 Fior di Bosco Bullnose  
4"x24" . 10x60 cm

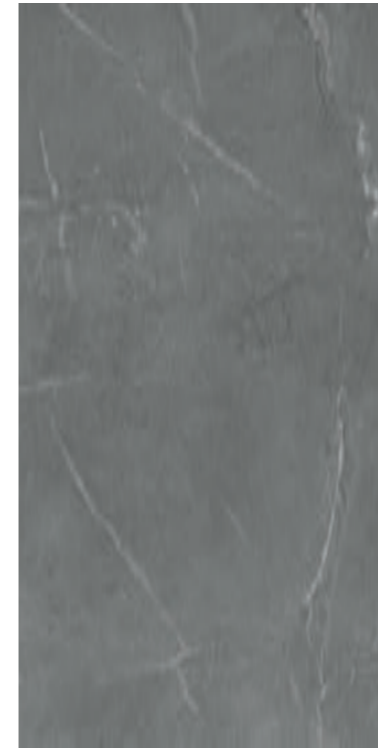

**80NA15R**  
Nature NA15 Belvedere Rect.  
24"x48" . 60x120 cm

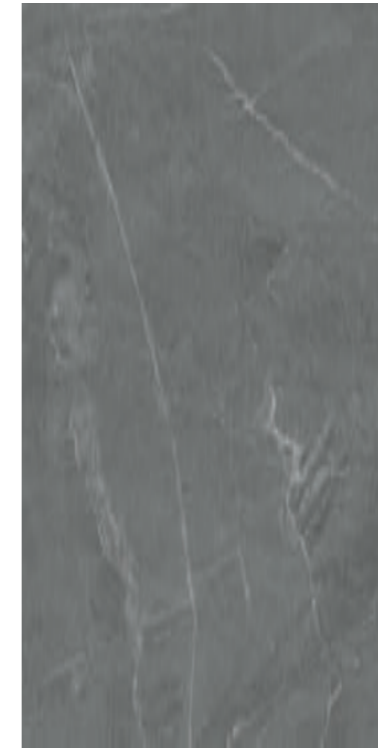

**80NA15S** **MADE IN ITALY**  
Nature NA15 Belvedere **Polished** Rect.  
24"x48" . 60x120 cm



**30NA15**  
Nature NA15 Belvedere Rect.  
4"x12" . 10x30 cm

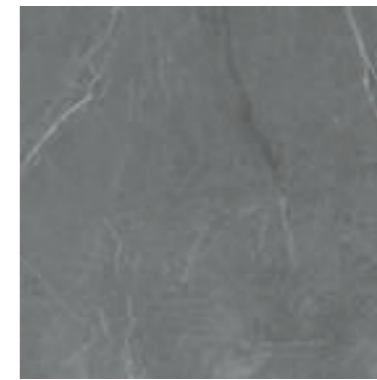

**60NA15R**  
Nature NA15 Belvedere Rect.  
24"x24" . 60x60 cm



**63NA15R**  
Nature NA15 Belvedere Rect.  
12"x24" . 30x60 cm

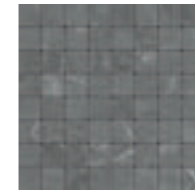

**32NA15MO**  
Nature NA15 Belvedere Mosaic\*  
(sheet 12"x12" . 30x30 cm)

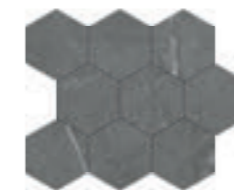

**32NA15HEX1**  
Nature NA15 Belvedere Hexagon\*  
(sheet 10"x12" . 26x30 cm)



**13NA15**  
Nature NA15 Belvedere Bullnose  
4"x24" . 10x60 cm

Marble Effect



# Concrete Effect





Concrete Effect

# Essential

24"x48" 24"x24" 12"x24" 4"x12" Rectified Collection

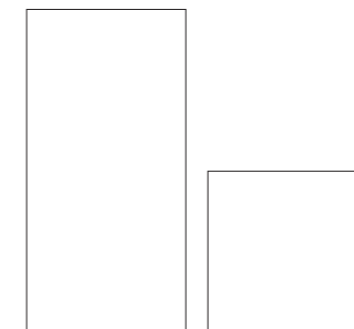

24"x48" . 60x120 cm 24"x24" . 60x60 cm



12"x24" . 30x60 cm 4"x12" . 10x30 cm

Colored Body Porcelain Stoneware

ANSI A 137.1 compliant

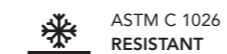

Essential  
HET01 Beige



Essential  
HET10 White



Essential  
HET05 Gray



Essential  
HET08 Graphite

## Graphics number

Sizes	Essential HET01 Beige	Essential HET10 White	Essential HET05 Gray	Essential HET08 Graphite
24"x48"	10	10	10	10
24"x24"	20	20	20	20
12"x24"	40	40	40	40

## Packaging

Sizes	Pieces					
		Sq.Ft.	Lbs.	Boxes	Sq.Ft.	Lbs.
24"x48"	2	15.50	61.00	36	558.00	2236.00
24"x24"	6	23.25	91.50	24	558.00	2236.00
12"x24"	8	15.50	61.40	32	496.00	1932.48
4"x12"	36	11.65	46.45	40	466.00	1858.00
12"x24" essential design	8	15.50	61.40	32	496.00	1932.48
12"x12" mosaic	10	9.70	-	-	-	-
12"x12" card mosaic	10	9.70	-	-	-	-
4"x24" bullnose	10	-	-	-	-	-

## Essential 2

due2 Porcelain Pavers available

Concrete Effect



# Essential

24"x48" 24"x24" 12"x24" 4"x12"

HET



Concrete Effect

Concrete Effect



# Essential

24"x48" 24"x24" 12"x24" 4"x12"

HET



Concrete Effect

Concrete Effect



# Essential

24"x48" 24"x24" 12"x24" 4"x12"

HET

Concrete Effect



214 Wall: Essential HET08 Graphite Rect. 12"x24" - Essential Design Rect. 12"x24" - Woodland HWL03 Nature Rect. 8"x48"



Concrete Effect

Floor: Essential HET01 Beige Rect. 24"x48" 215



# Essential

24"x48" 24"x24" 12"x24" 4"x12"

Concrete Effect

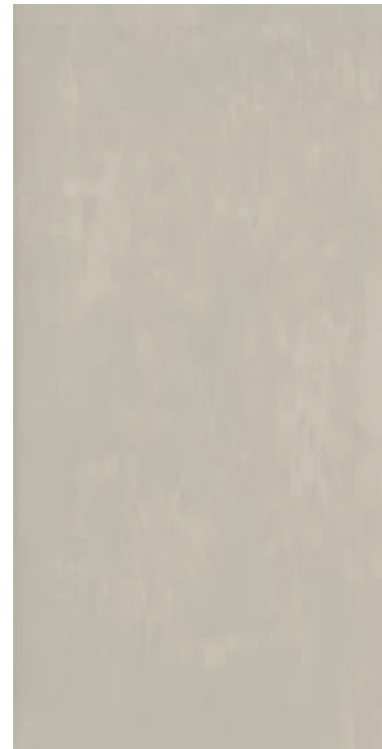

**GCET01R**  
Essential HET01 Beige Rect.  
24"x48" . 60x120 cm



**G8ET01R**  
Essential HET01 Beige Rect.  
12"x24" . 30x60 cm

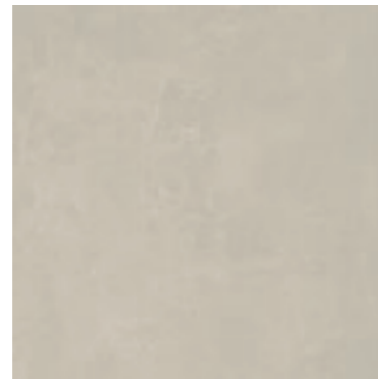

**G9ET01R**  
Essential HET01 Beige Rect.  
24"x24" . 60x60 cm



**30ET01**  
Essential HET01 Beige Rect.  
4"x12" . 10x30 cm

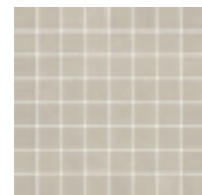

**G3ET01MO**  
Essential HET01 Beige Mosaic\*  
1 3/8"x1 3/8" . 3,5x3,5 cm  
(sheet 12"x12" . 30x30 cm)



**G3ET01MOC**  
Essential HET01 Beige Card Mosaic\*  
1 3/16"x4" . 3x10 cm  
(sheet 12"x12" . 30x30 cm)



**G0ET01**  
Essential HET01 Beige Bullnose  
4"x24" . 10x60 cm



**GCET10R**  
Essential HET10 White Rect.  
24"x48" . 60x120 cm



**G8ET10R**  
Essential HET10 White Rect.  
12"x24" . 30x60 cm

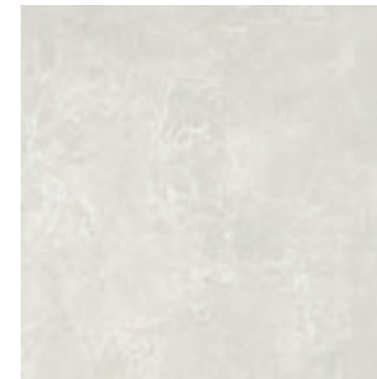

**G9ET10R**  
Essential HET10 White Rect.  
24"x24" . 60x60 cm



**30ET10**  
Essential HET10 White Rect.  
4"x12" . 10x30 cm

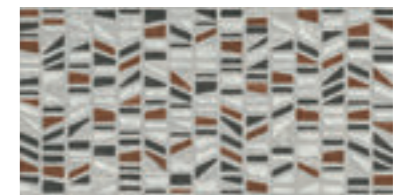

**G8ETDESIGNR**  
Essential Design Rect.  
12"x24" . 30x60 cm

The Design decoration can be used in both wall and floor tiles, and also in combination with the Woodland series.



**G0ET10**  
Essential HET10 White Bullnose  
4"x24" . 10x60 cm

Concrete Effect



# Essential

24"x48" 24"x24" 12"x24" 4"x12"

Concrete Effect



**GCET05R**  
Essential HET05 Gray Rect.  
24"x48" . 60x120 cm



**G8ET05R**  
Essential HET05 Gray Rect.  
12"x24" . 30x60 cm

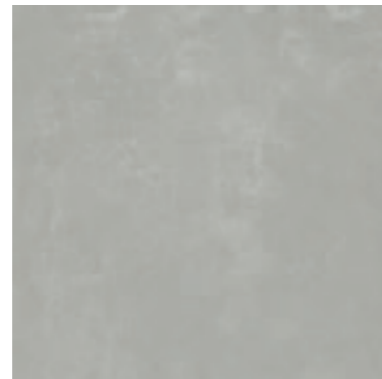

**G9ET05R**  
Essential HET05 Gray Rect.  
24"x24" . 60x60 cm



**30ET05**  
Essential HET05 Gray Rect.  
4"x12" . 10x30 cm

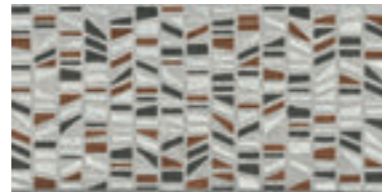

**G8ETDESIGNR**  
Essential Design Rect.  
12"x24" . 30x60 cm

The Design decoration can be used in both wall and floor tiles, and also in combination with the Woodland series.

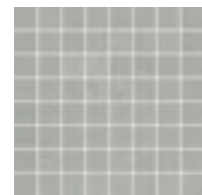

**G3ET05MO**  
Essential HET05 Gray Mosaic\*  
(sheet 12"x12" . 30x30 cm)



**G3ET05MOC**  
Essential HET05 Gray Card Mosaic\*  
(sheet 12"x12" . 30x30 cm)



**G0ET05**  
Essential HET05 Gray Bullnose  
4"x24" . 10x60 cm



**GCET08R**  
Essential HET08 Graphite Rect.  
24"x48" . 60x120 cm



**G8ET08R**  
Essential HET08 Graphite Rect.  
12"x24" . 30x60 cm

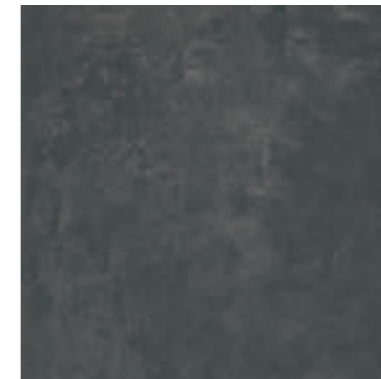

**G9ET08R**  
Essential HET08 Graphite Rect.  
24"x24" . 60x60 cm



**30ET08**  
Essential HET08 Graphite Rect.  
4"x12" . 10x30 cm

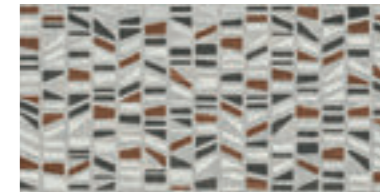

**G8ETDESIGNR**  
Essential Design Rect.  
12"x24" . 30x60 cm

The Design decoration can be used in both wall and floor tiles, and also in combination with the Woodland series.



**G3ET08MO**  
Essential HET08 Graphite Mosaic\*  
(sheet 12"x12" . 30x30 cm)

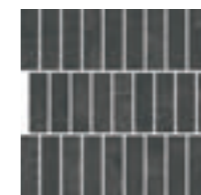

**G3ET08MOC**  
Essential HET08 Graphite Card Mosaic\*  
(sheet 12"x12" . 30x30 cm)



**G0ET08**  
Essential HET08 Graphite Bullnose  
4"x24" . 10x60 cm

HET

Concrete Effect



# Brick Effect

Kensington	222
Cantina	230





# Kensington

3"x16"



3"x16" . 7,5x40 cm

Glazed Porcelain Stoneware

ANSI A 137.1 compliant

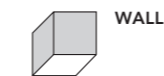

WALL



MODERATE



0.34 in  
8.5 mm



ASTM C 1026  
RESISTANT



ASTM C 373  
~0.1%



ASTM C 650: CLASS A  
ASTM C 1378: CLASS A

Made in San Marino

Pressed Collection



Kensington  
KT10 Bianco



Kensington  
KT01 Beige

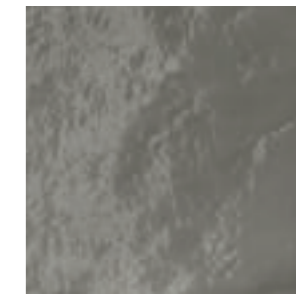

Kensington  
KT08 Nero

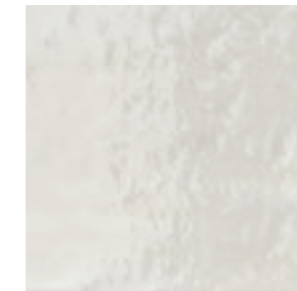

Kensington  
KT20 Ice



Kensington  
KT02 Blue

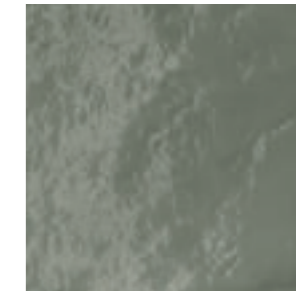

Kensington  
KT03 Green

Graphics number

Sizes	Kensington KT10 Bianco	Kensington KT01 Beige	Kensington KT08 Nero	Kensington KT20 Ice	Kensington KT02 Blue	Kensington KT03 Green
3"x16"	48	48	48	48	48	48

Packaging

Sizes	Pieces	Sq.Ft.	Lbs.	Boxes	Sq.Ft.	Lbs.
3"x16"	44	14.21	54.19	36	511.50	1995.20



# Kensington

3"x16"

KT

Brick Effect



Brick Effect



# Kensington

3"x16"

KT



Brick Effect

Brick Effect





Wall: Kensington KT10 Bianco 3"x16"

# Kensington

3"x16"



**74KT10**  
Kensington KT10 Bianco  
3"x16" . 7,5x40 cm



**74KT20**  
Kensington KT20 Ice  
3"x16" . 7,5x40 cm

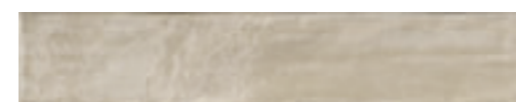

**74KT01**  
Kensington KT01 Beige  
3"x16" . 7,5x40 cm



**74KT02**  
Kensington KT02 Blue  
3"x16" . 7,5x40 cm

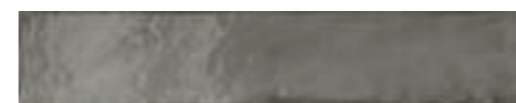

**74KT08**  
Kensington KT08 Nero  
3"x16" . 7,5x40 cm

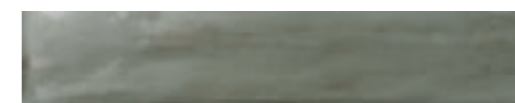

**74KT03**  
Kensington KT03 Green  
3"x16" . 7,5x40 cm





# Cantina

4"x12"

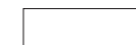

4"x12" . 10x30 cm

Glazed Porcelain Stoneware

Pressed Collection



Cantina  
CA10 Bianco



Cantina  
CA06 Rosso



Cantina  
CA08 Nero

ANSI A 137.1 compliant



WALL / FLOOR



RANDOM



0.34 in  
8.5 mm



ASTM C 1026  
RESISTANT



ASTM C 373  
~0.1%



ASTM C 650: CLASS A  
ASTM C 1378: CLASS A



ANSI A326.3: 2021.  
(DCOF): ≥0,42





HEAVY USE

Made in San Marino

Graphics number

Sizes	Cantina CA10 Bianco	Cantina CA06 Rosso	Cantina CA08 Nero
4"x12"	53	72	64

Packaging

Sizes						
	Pieces	Sq.Ft.	Lbs.	Boxes	Sq.Ft.	Lbs.
4"x12"	32	10.34	37.10	60	620.00	2226.00



# Cantina

4"x12"

CA

Brick Effect



Brick Effect





Wall: Cantina CA08 Nero 4"x12"

# Cantina

4"x12"



**30CA10J**  
Cantina CA10 Bianco  
4"x12" . 10x30 cm



**30CA06J**  
Cantina CA06 Rosso  
4"x12" . 10x30 cm

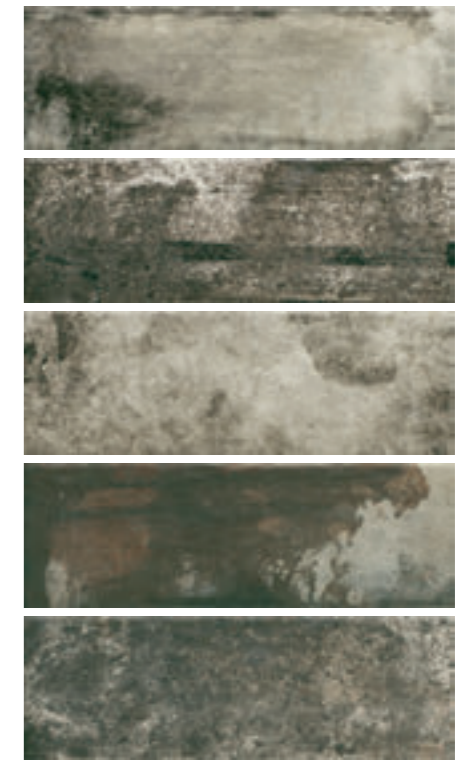

**30CA08J**  
Cantina CA08 Nero  
4"x12" . 10x30 cm



# Decorative Effect

Fragrance 238





Wall: Fragrance FR 4 / Verde Acqua Brick 3"x16"  
 Fragrance FR 10 / Bianco Macro 8"x8"  
 Floor: Fragrance FR 10 / Bianco Macro 8"x8"

# Fragrance

8"x8" 3"x16"



8"x8" . 20x20 cm



3"x16" . 7,5x40 cm

Glazed Porcelain Stoneware

ANSI A 137.1 compliant



8"x8": WALL / FLOOR



3"x16": WALL



MODERATE



0.34 in  
8.5 mm



ASTM C 1026  
RESISTANT



ASTM C 373  
~0.1%



ASTM C 650: CLASS A  
ASTM C 1378: CLASS A



ANSI A326.3: 2021.  
(DCOF): ≥0,42



MEDIUM USE (8"x8")

Made in San Marino

Pressed Collection

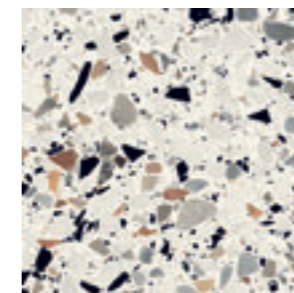

Fragrance  
FR10 Bianco

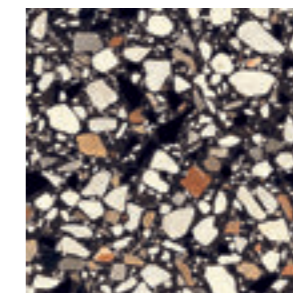

Fragrance  
FR08 Nero

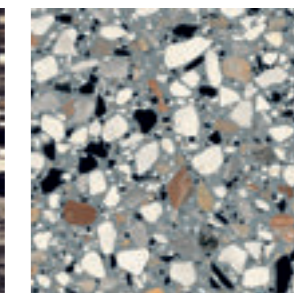

Fragrance  
FR02 Azzurro

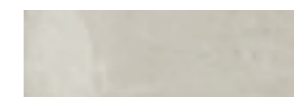

Fragrance  
FR10 Bianco

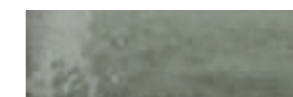

Fragrance  
FR04 Verde Acqua

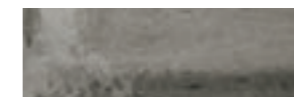

Fragrance  
FR05 Grigio



Fragrance  
FR02 Azzurro



Fragrance  
FR08 Nero



Fragrance  
FR12 Blu Notte

Graphics number

Sizes	Fragrance FR10 Bianco	Fragrance FR02 Azzurro	Fragrance FR08 Nero	Fragrance FR04 Verde Acqua	Fragrance FR05 Grigio	Fragrance FR12 Blu Notte
8"x8"	25	25	25			
3"x16"	12	13	12	12	12	12

Packaging

Sizes						
	Pieces	Sq.Ft.	Lbs.	Boxes	Sq.Ft.	Lbs.
8"x8"	29	12.49	48.78	45	561.87	2240.00
3"x16"	44	14.21	54.19	36	511.50	1995.20



# Fragrance

8"x8" 3"x16"

FR

Decorative Effect



Decorative Effect



# Fragrance

8"x8" 3"x16"

FR

Decorative Effect



242 Wall: Fragrance FR12 Blu Notte Brick 3"x16"



Decorative Effect

243 Wall: Fragrance FR02 Azzurro Macro 8"x8"





Wall: Fragrance FR05 Grigio Brick 3"x16"

# Fragrance

8"x8" 3"x16"

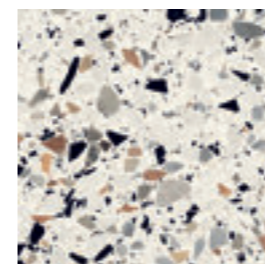

**20FR10MA**  
Fragrance FR10 Bianco Macro  
8"x8" . 20x20 cm

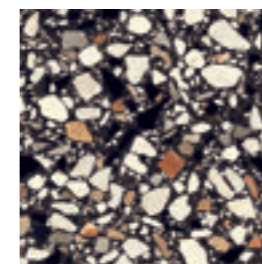

**20FR08MA**  
Fragrance FR08 Nero Macro  
8"x8" . 20x20 cm

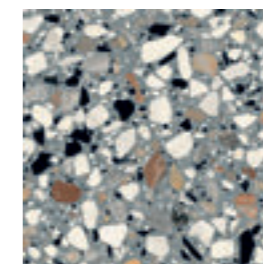

**20FR02MA**  
Fragrance FR02 Azzurro Macro  
8"x8" . 20x20 cm



**74FR10**  
Fragrance FR10 Bianco Brick  
3"x16" . 7,5x40 cm



**74FR04**  
Fragrance FR04 Verde Acqua Brick  
3"x16" . 7,5x40 cm

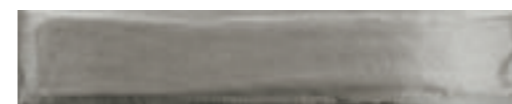

**74FR05**  
Fragrance FR05 Grigio Brick  
3"x16" . 7,5x40 cm

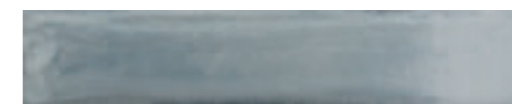

**74FR02**  
Fragrance FR02 Azzurro Brick  
3"x16" . 7,5x40 cm



**74FR08**  
Fragrance FR08 Nero Brick  
3"x16" . 7,5x40 cm



**74FR12**  
Fragrance FR12 Blu Notte Brick  
3"x16" . 7,5x40 cm



# Technical characteristics

# Key to symbols

# Layouts

## TECHNICAL CHARACTERISTICS AND STANDARDS OF REFERENCE

Our first choice porcelain tiles are compliant with ISO 13006 & ANSI A137.1 standard. Therefore they must not be perfect (which is impossible for any industrial product) but fall within the tolerances defined by the standard. The valuation of the appearance of the tiles shall be performed, as defined by the standard, placing tiles on a viewing board and examining it (perpendicularly) from a distance of at least 1 meter (3.3 feet). Defects of tiles can be of two types: noticeable (already visible before setting, such as color differences, surface defects, fractures, etc) or hidden (not visible before setting). Claims about noticeable defects may be made only before tiles are installed, allowing the manufacturer to replace any defective material. However, if the buyer or tile installer decides to proceed with installation, the responsibility of the manufacturer is invalidated. No claims will be accepted regarding installed product. Responsibility for hidden defects remains with the producer if these are notified within the legal time limits.

Catalogs indicate nominal size, not actual size.



## RECOMMENDATIONS FOR USE

No laboratory test, however efficient it may be, is sufficient to determine the durability of a product. Apart from the obvious factor of the number of foot contacts, durability can also be influenced by the technical characteristics of the product, location of the installation and the possible presence of abrasive agents. We therefore recommend not only that products should be chosen with resistance characteristics that are sufficient for the intended use, as shown in the following chart, but also that floors should be protected against sand, grit and other abrasives with the use, for example, of mats.

See [www.delconcausa.com/download/edpceramictile.pdf](http://www.delconcausa.com/download/edpceramictile.pdf) to download the EPD report covering Del Conca USA products.

## ANSI A 137.1





### Colored Body Porcelain Stoneware Glazed Porcelain Stoneware

	Established limits	Performances	Norms
 <b>Water absorption</b>	≤ 0,5%	~ 0,1%	ASTM C 373
 <b>Breaking strength (1)</b>	≥ 250 lbf.	<b>Conforms</b>	ASTM C 648
 <b>Resistance to freeze-thaw cycling</b>	Resistant	<b>Frost proof</b>	ASTM C 1026
 <b>Resistance to thermal shock</b>	Resistant	<b>Resistant</b>	ASTM C 484
 <b>Slip resistance (DCOF)</b>	≥ 0,42	<b>Only for Natural Surface Conforms</b>	ANSI A326.3: 2021 (DCOF)
 <b>Chemical resistance</b>	As reported	<b>Class: A</b>	ASTM C 650
 <b>Stain resistance</b>	As reported	<b>Class: A</b>	ASTM C 1378



Reference values valid for almost all our collections. Browse through our website for further specifications.

(1) It states the resistance of a sample piece, leaning on three spots, to a concentrated load placed in the middle.

## SHADE VARIATIONS

-  **LOW**  
Uniform colour with only minimal differences between tiles in the same production run.
-  **MODERATE**  
Clearly distinguishable differences in texture and pattern within the same production run.
-  **HIGH**  
Significant variation in texture, pattern and colour from tile to tile within the same production run. The colour range should be viewed before selecting the material.
-  **RANDOM**  
Random differences from tile to tile. One tile may have totally different texture and colour from another. The colour range should be viewed before selecting the material.

## RECOMMENDED USE

-  Recommended for floors for medium-light use, as in private homes, with the exception of kitchens and rooms with direct outdoor access.
-  Recommended for all rooms in the house and for business premises with medium use.
-  Recommended for all rooms indoors and outdoors and for business premises in general.

## 1. Fragrance (3"x16" . 7,5x40 cm)

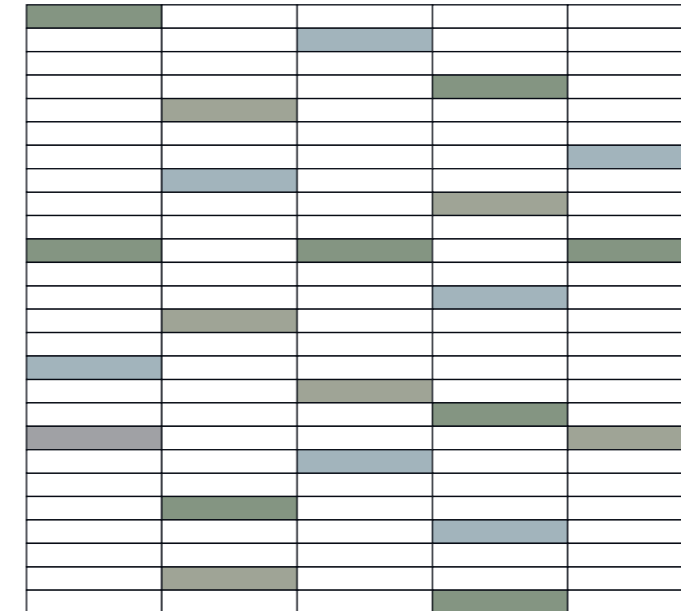

PRODUCTS	PERCENTAGES	PIECES
FR10 Bianco Brick	83.08%	108
FR04 Verde Acqua Brick	6.15%	8
FR05 Grigio Brick	5.38%	7
FR02 Azzurro Brick	5.38%	7

## 3

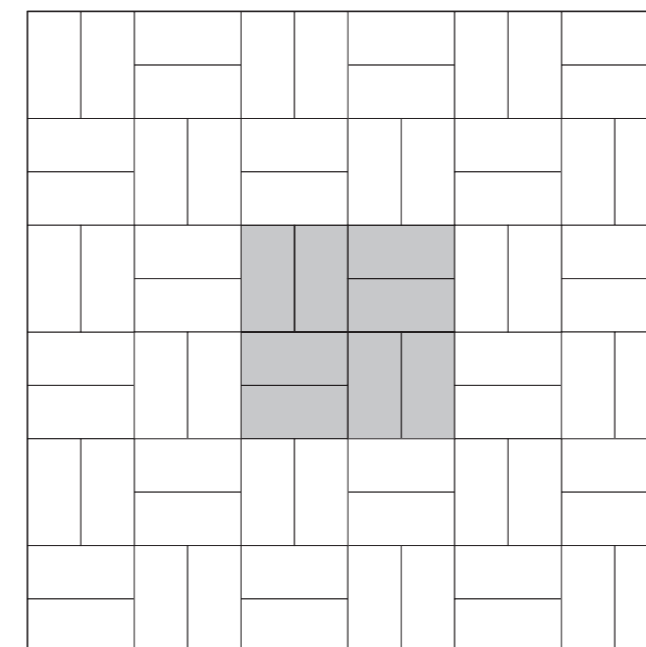

FORMATS	%	PIECES/SQ.FT
24"x48"	100%	0.129

## 2. Fragrance (3"x16" . 7,5x40 cm)



PRODUCTS	PERCENTAGES	PIECES
FR10 Bianco Brick	44.29%	62
FR04 Verde Acqua Brick	50%	70
FR12 Blu Notte Brick	5.71%	8

## 4

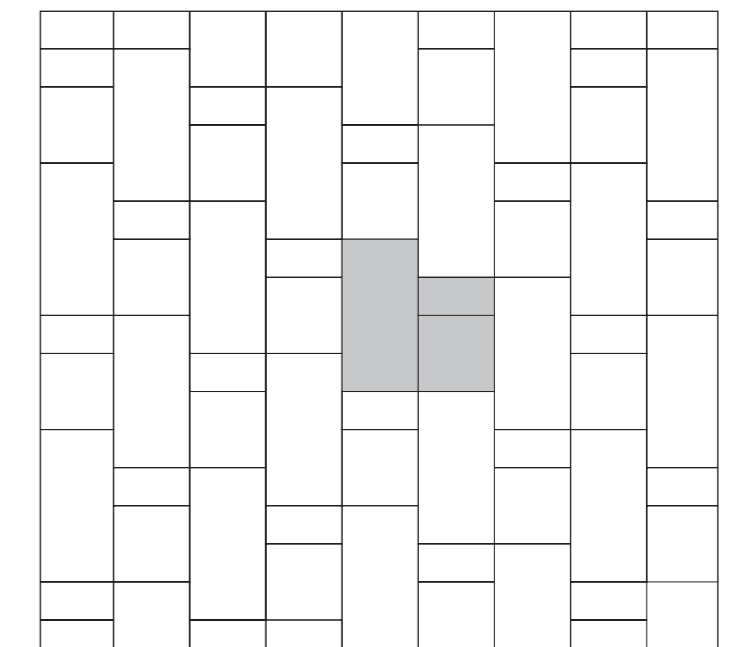

FORMATS	%	PIECES/SQ.FT
24"x48"	57.14%	0.0700
24"x24"	28.57%	0.0700
12"x24"	14.29%	0.0700

Match shades before installation



# Mosaics and Muretto sizes

**Mosaic**

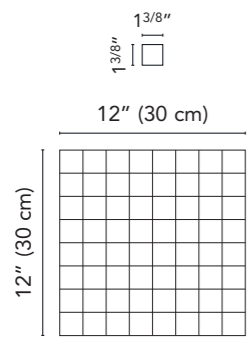

Available on series:

- Horizons
- New England
- Quartzite
- Navona
- Chamonix
- Nature
- Essential

**Mosaic**

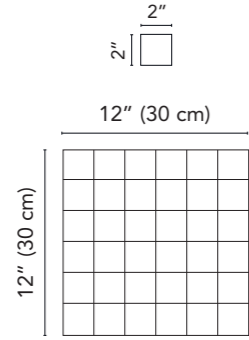

Available on series:

- Endless
- Verona
- Woodscape
- Neopolis
- Gotham
- Clast

**Mosaic**

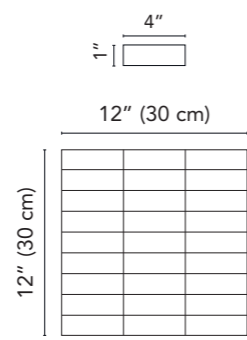

Available on series:

- West 57th

**Card Mosaic**

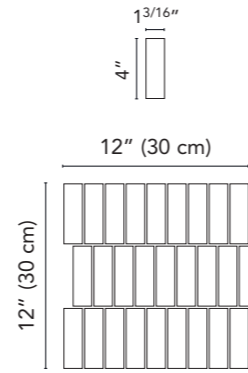

Available on series:

- Essential

**Brick**

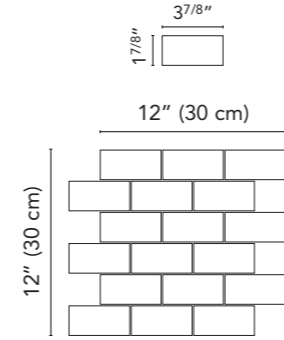

Available on series:

- New England

**Herringbone Mosaic**

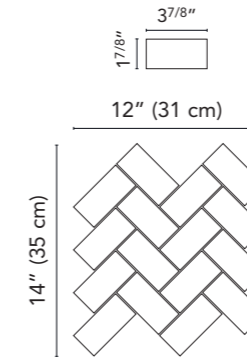

Available on series:

- New England

**Muretto Wall**

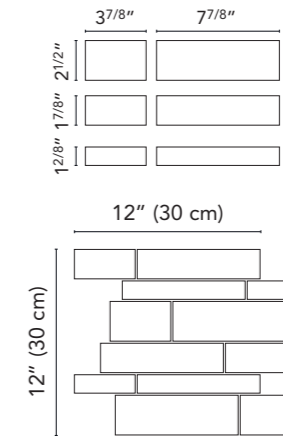

Available on series:

- Quartzite
- Navona

**Capri Mosaic**

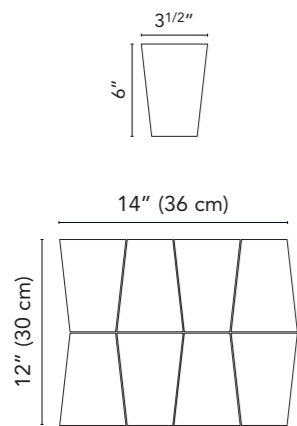

Available on series:

- Neopolis

**Hexagon**

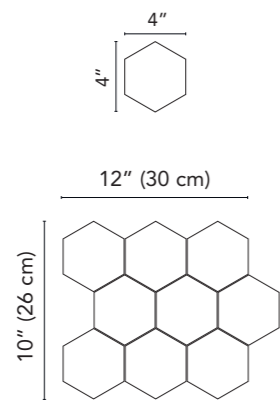

Available on series:

- Horizons
- Chamonix
- Nature

**Intreccio**

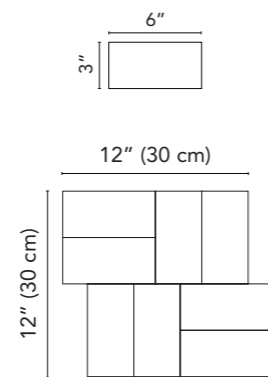

Available on series:

- Gotham

**Muretto Brick**

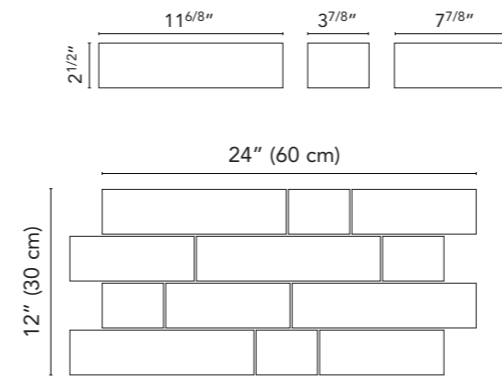

Available on series:

- Chamonix

**Muretto**

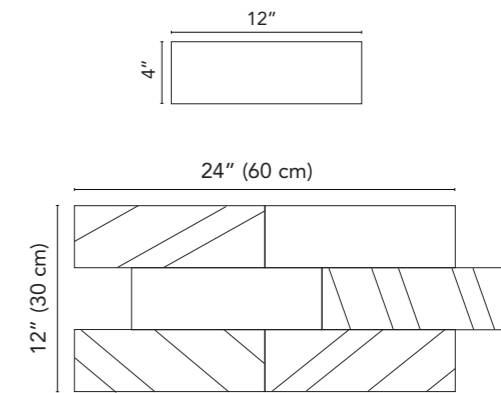

Available on series:

- West 57th



# Terms and conditions of sale

1. These Terms and Conditions of Sale shall apply to all orders and contracts entered into by Del Conca USA, Inc. (the "Seller" or "Del Conca") and the Purchaser for the sale of products manufactured or distributed by Del Conca USA (the "Products") unless Seller otherwise specifically agrees in writing. By placing any order for Products, the Purchaser agrees to these Terms and Conditions of Sale. Any other terms or conditions which may at any time be indicated by the Purchaser, in the Purchaser's order form or otherwise (whether oral, typed, written or printed) shall be null and void and of no effect, even if not expressly objected to by the Seller.

2. All prices are stated in U.S. Dollars per square foot or per piece unless otherwise noted.

3. Prices are for first choice material only.

4. Full Truckload (FTL) prices are applied only to orders for shipment of at least 43,000 pounds (including pallet weight) from the Loudon, TN factory and comprised exclusively of materials stored at that specific facility.

5. All pricing is calculated FOB Factory (Loudon, TN), excluding transportation and shipping charges, taxes, fees and custom duties.

6. The Purchaser shall make all payments pursuant to the invoices issued by the Seller, notwithstanding any claim for any alleged defect, fault or irregularity in the Products. Unless otherwise specifically agreed by the Seller in writing, payment by the Purchaser is due upon receipt of Seller's invoice. Invoice for FTL shall be payable within 30 days from the issuance of the invoice. In the event of any delay in payment, the Seller shall have the right to suspend deliveries and may, at its option (i) require immediate payment of all or any part of any and all sums owed by the Purchaser, irrespective of any credit terms previously agreed to, and (ii) terminate the Contract (as well as any and all other contracts with the Purchaser) in whole or in part, and hold the Purchaser liable for damages. In addition, in the event the Seller does not receive full payment by the due date, the Purchaser shall pay to the Seller interest on the unpaid amount, from the due date to the date payment is actually received by the Seller, at the monthly rate of interest of one and one half percent (1 ½%), but not to exceed the highest amount allowed by law. Seller's right to such interest shall be in addition to, and not in lieu of, all other rights and remedies arising by reason of such nonpayment. Any payment received by the Seller may be applied to any outstanding balance owed by the Purchaser to the Seller, as the Seller, in its sole discretion, may determine, any instructions of the Purchaser to the contrary notwithstanding.

7. Del Conca USA reserves the right to apply a surcharge on orders comprising non-full pallets.

8. All orders are subject to availability. No order of the Purchaser will be binding upon Del Conca USA unless accepted by Del Conca USA on Del Conca USA's form of Order Confirmation, signed by an officer or employee of Del Conca USA duly authorized to sign on behalf of Del Conca USA, and then only as and to the extent set forth in such Order Confirmation. Del Conca USA reserves the right to reject any order in whole or in part. Any term, condition or provision set forth in Seller's Order Confirmation which is not objected to by the Purchaser in writing within ten days after the date thereof will conclusively be deemed to have been accepted by the Purchaser. Every order of the Purchaser will be binding on the Purchaser unless and until it is rejected in writing by the Seller, and may not be cancelled, withdrawn or modified by the Purchaser; however, in the event of a partial acceptance by the Seller, the Purchaser will no longer be bound with respect to the parts of the order not accepted by the Seller.

9. Purchaser will take delivery of the Products at the Seller's premises ("ex factory"). Unless otherwise specifically agreed by Seller in writing: (i) all risk of loss or damage to the Products shall pass to the Purchaser upon delivery of the Products by the Seller to a carrier; (ii) the Seller shall not be required to procure insurance to cover the Products during transportation in shipment; (iii) any shipping arrangements made by the Seller with carriers or forwarding agents at the Purchaser's request shall be made solely on the Purchaser's behalf and at the Purchaser's sole cost and risk; (iv) any agent appointed for such shipment shall be solely the Purchaser's agent for all purposes; (v) the Purchaser shall be responsible for all the unloading and receipt of the Products at its destination; and (vi) any claim for loss or damage shall be made by the Purchaser solely against the carrier.

10. Any delivery dates specified by the Seller will be deemed to be estimates only, unless specific commitments are made in writing by the Seller. In no event is the time of delivery of the Products of the essence. The Seller reserves the right to cancel, in whole or in part, or to suspend or delay, in whole or in part, any orders due to (i) shortages of, or failures of Seller's suppliers to deliver, or delays of Seller's suppliers in delivering materials, (ii) work stoppages or other labor troubles, (iii) acts of God or (iv) any event in the nature of force majeure or beyond Seller's control. Delivery dates will be extended by the amount of any additional time required by the Seller to make delivery as a result of any such condition or event. The Seller also reserves the right to discontinue particular Products or lines of Products, or to substitute other Products or lines, in response to production and market requirements and demands. The Purchaser waives any and all claims and rights which the Purchaser might otherwise have arising out of or in connection with or relating to any delay in delivery of the Products for any reason whatsoever or any failure of the Seller to deliver by reason of the exercise by the Seller of any of its rights pursuant to these Terms and Conditions of Sale, including, without limitation, any and all claims for or rights to direct, indirect, incidental, consequential or other damages or compensation, and any and all rights to terminate or cancel the order, in whole or in part.

11. Product representations made in photographs, catalogs, advertisement, sampling and online formats as well as in any other publications are indicative of the product only. Variations in color finish and size can occur and the Seller does not warrant the uniformity of color, tone or shade of the Products or the conformity of the Products to the color, tone or shade of any sample. It is Purchaser's responsibility to verify the suitability of the material before installation.

12. Any Product return shall be previously authorized by Del Conca USA and returned products must be accompanied by an approved Return Authorization form and is subject to a 25% handling charge. Freight for the return is the responsibility of the Purchaser.

13. Limited Warranty / Product Claims: Del Conca USA warrants that its first choice, domestically produced ceramic tile is manufactured according to ANSI A137.1 and meets or exceeds these requirements. If a first choice tile purchased by the Purchaser pursuant to these Terms and Conditions of Sale is proven to contain a manufacturing defect, Del Conca USA will supply, free of charge, material of compatible color and shade, as determined by Del Conca USA. **Labor charges are expressly excluded from this warranty.** The Purchaser waives any and all other claims and rights which the Purchaser might otherwise have arising out of or in connection with or relating to any breach of warranty or arising out of or in connection with or relating to any defect, fault or irregularity in the Products, including, without limitation, any and all claims for or rights to direct, indirect, incidental, consequential or other compensation or damages, and any and all rights to terminate or cancel the order, in whole or in part.

14. Del Conca USA makes no warranty as to the suitability of its tile for a particular installation. Del Conca USA does not warrant that its glazed or unglazed tile will not scratch, chip, or show signs of wear.

15. Del Conca USA must be notified by the Purchaser of any claims or defects as soon as reasonably possible, but in any case not later than six months after the Products have been delivered by Del Conca USA. Any claim of the Purchaser of any and every kind must be in writing and sent by certified mail, return receipt requested. Failure to make any claim in such manner or within such six month period shall constitute an irrevocable acceptance of the Products.

16. Claims concerning shade, appearance, caliber, finish or obvious defects in first choice production must be communicated before the tile is installed. No claims will be accepted for tile already installed or for defects in other than first choice material.

17. Del Conca USA specifically excludes liability for consequential or incidental damages except where exclusion of consequential damage is not permitted by state law.

18. This limited warranty shall constitute the full extent of Del Conca USA's liability and is in place of all other warranties or representations, express or implied, including, without limitation, any warranty of merchantability or fitness for a particular purpose.

19. Until the Seller collects in full all amounts required to be paid by the Purchaser for the Products, as well as any and all other amounts owed by the Purchaser to the Seller, the Seller retains title to the Products, and shall have a first and senior purchase money security interest in, an lien on, the Products and all proceeds thereof, under the Uniform Commercial Code as in effect in the United States, to secure the payment of all such amounts. By placing an order with the Seller, the Purchaser authorizes the Seller to file any and all financing statements with respect to such security interest which Seller may deem necessary or desirable. The Purchaser shall, at the request of the Seller, execute any and all financing statements and other documents which the Seller may request to perfect or evidence such title and such security interest.

20. In the event the Seller retains a collection agency to collect any amount owed by the Purchaser, or institutes proceedings to collect such amount or to enforce any right against the Purchaser, including enforcement of any security interest granted to the Seller, the Purchaser shall reimburse the Seller for all collection agency fees and costs, or all costs incurred in such legal proceedings, including reasonable attorneys' fees.

21. The Parties agree that the laws of the State of Tennessee (without giving effect to principles of conflicts of law), to the exclusion of the laws of any other state, shall be applicable to all orders or contracts entered into pursuant to this Terms and Conditions of Sale, their construction, interpretation, effect, performance or non-performance or the consequences thereof. For all disputes or controversies which may arise between the Parties out of or in connection with all orders or contracts entered into pursuant to this Terms and Conditions of Sale, their construction, interpretation, effect, performance or non-performance or the consequences thereof, the Parties hereby consent to the jurisdiction of the courts in the State of Tennessee, and agrees that such courts, to the exclusion of all other courts, shall have exclusive jurisdiction with respect to any and all such disputes and controversies.





## Tile Council of North America (TCNA)

---

TCNA is the trade association representing manufacturers of ceramic tile, tile installation materials, tile equipment, raw materials, and other tile-related products of North America.

For further information, please visit [www.delconcausa.com](http://www.delconcausa.com)

The company reserves the right to make any change to products and features shown in this catalogue. All colors are purely representative.

Any kind of copy of this catalogue, even partial reproduction, is prohibited.

© 2024 Del Conca USA, Inc. All rights reserved.

JANUARY / 2024





Del Conca USA, Inc. - 155 Del Conca Way  
Loudon, TN 37774 - USA  
Tel 865.657.3550 - Fax 865.657.3554  
[www.delconcausa.com](http://www.delconcausa.com) - [sales@delconcausa.com](mailto:sales@delconcausa.com)