



LAMILUX GLASS SKYLIGHTS

DAYLIGHT FOR A SENSE OF WELL-BEING

FIND THE OPTIMUM GLASS SKYLIGHT FOR YOUR CONSTRUCTION PROJECT

"You can find the best flat skylight for your project with us – this is our claim. Our daylight systems combine high energetic qualities, modern and attractive designs, durability and functionality even in extreme weather conditions, simple installation and optimal renovation solutions. Only when everyone on the construction site and in the building is satisfied with our Glass Skylights are we satisfied!"

Michael Blechschmidt Head of Sales Daylight Systems



The LAMILUX CI Philosophy

Customer value is the reason we exist – and the focus of our activities. This requires harmony, identity and a balance between customer value and company strategy.

The principles that guide our company's actions and customer relations are set out in LAMILUX's company philosophy:

Customized Intelligence – serving customers is our first priority: This requires outstanding performance and leadership in all areas relevant to customers, particularly in the role of:

- A leader in quality – optimum benefit for customers
- A leader in innovation – at the cutting edge of technology
- A leader in service – fast, uncomplicated and friendly
- A leader in expertise – optimum sales and technical advisory services
- A leader in problem solving – individual, tailored solutions

LAMILUX

GLASS SKYLIGHT FE

Sophisticated design in a number of variants: the redevelopment of the LAMILUX Glass Skylight FE represents a new milestone in product development at LAMILUX. Architects, builders and building users benefit from an innovative frame profile and sophisticated design features with a wealth of additional benefits. The Skylight received the 2019 German Design Award, the Red Dot Design Award and the Plus X-Award.

The design of the new LAMILUX Glass Skylight FE can also be adapted to any construction project's overall architectural concept. Design freedom is offered, for example, a wide variety of glazing and sizes up to 2.5 x 2.5 metres, the concealed drive in the profile frame and the freely selectable exterior and interior colours of the skylight. It also impresses with its all-round optimum thermal insulation in a compact, thermal bridge-free overall system with certification in the Passivhaus class pH.C.

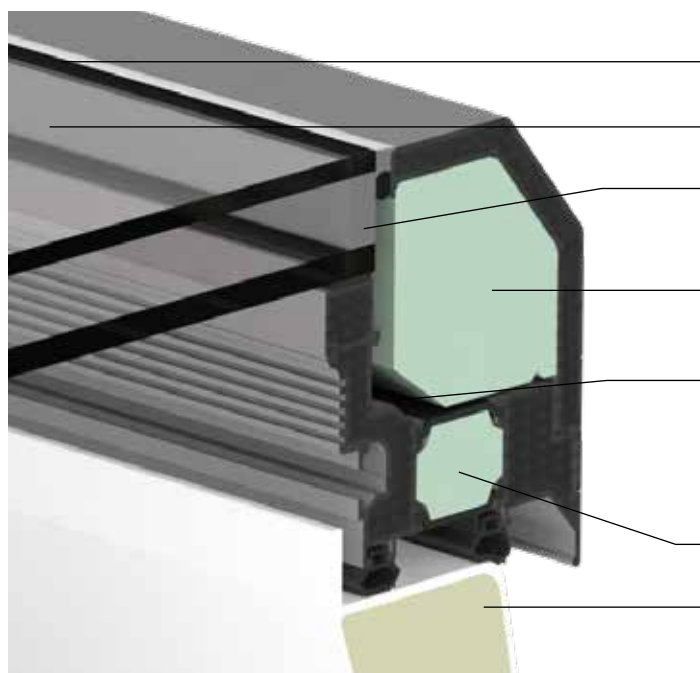

Structural Glazing design

Flat drainage surface

"Warm edge" (spacers between the panes, made of materials with low thermal conductivity) **as a standard feature**

Integration of all drives and components in the profile frame

TAD – Thermo active design: A patented component below the glazing support for surface enlargement absorbs more heat energy from the room air and thus contributes to the optimised isothermal curve

Thermally optimised insulation core

Heat-insulated upstand made of glass-fibre reinforced composite: Manufactured without joints (optional) and with a continuous insulation core made of PU foam, 60 mm thick

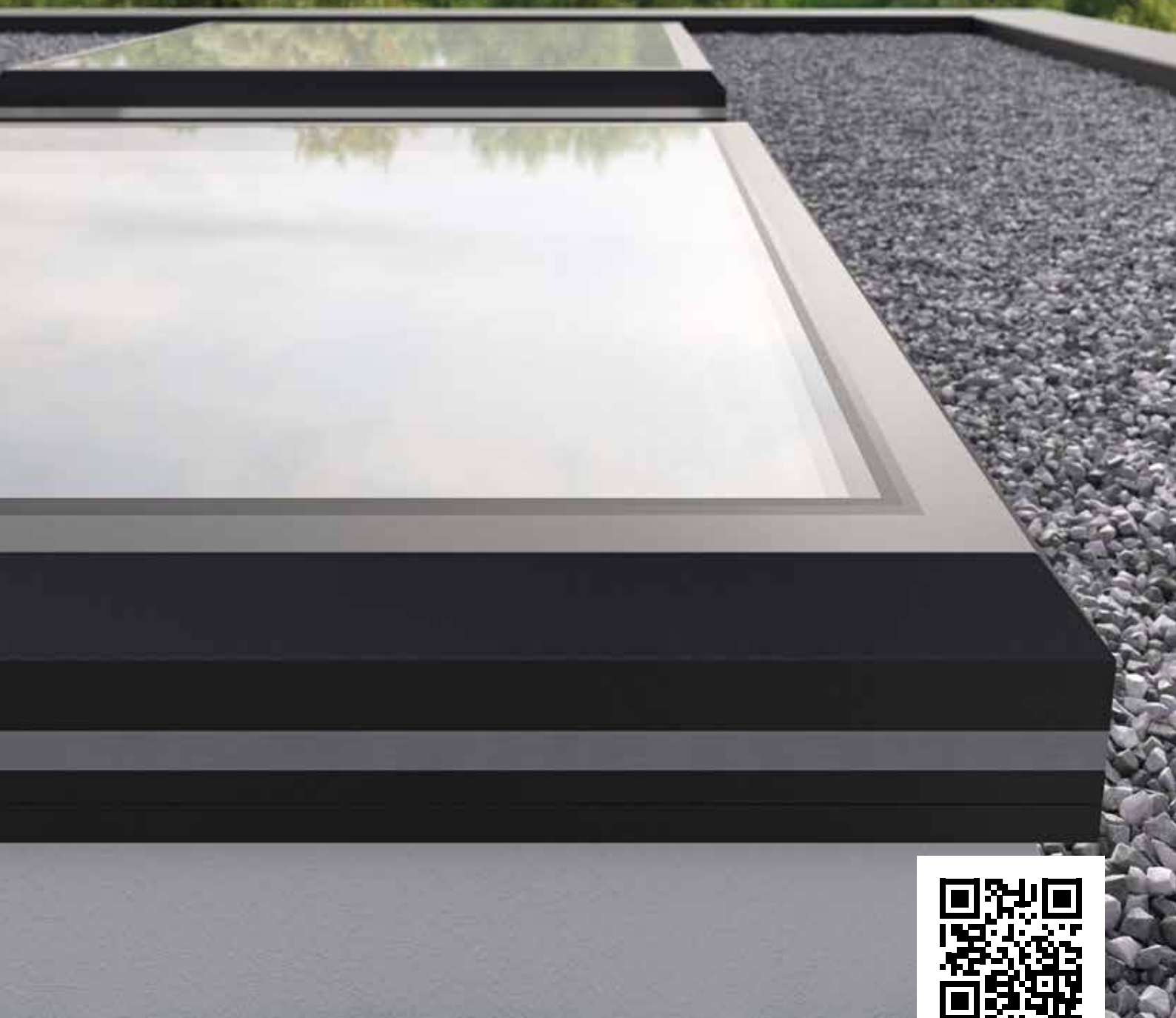



ENERGY EFFICIENCY

Savings on heating costs and minimised risk of condensation thanks to flawless isothermal characteristics

All-round optimum thermal insulation in a compact, thermal-bridge-free overall system with certification in the passive house class pHc

Preservation of a lot of thermal energy in the building thanks to the tight overall system

Seamless and waterproof upstand made of glass-fibre reinforced composite with integrated insulation

COMFORT & DESIGN

Uniform appearance throughout thanks to new joining technology: no visible screw joints or weld seams as well as four-sided flat water drain

Easy installation thanks to completely pre-assembled delivery of the skylight

The integration of all drives, power adapters, cables and other components into the frame of the skylight creates a smooth interior design

Variety of design and colours thanks to freely selectable exterior and interior colours of the Glass Skylight

FUNCTIONALITY IN EXTREME WEATHER EVENTS

Tested watertightness in heavy rain and during storms (highly impervious to driving rain, in accordance with DIN EN 12208, Class E 1950)

High stability against wind load (highest wind load class C5 according to DIN EN 12210)

Excellent air permeability (performance class 4 – EN 12207)

Optimised sound insulation and minimised rain noise due to special glazing ($R_w = 38$ dB)

SAFETY

Approved fall-through protection and accessibility for cleaning and maintenance purposes according to DIN 18008-6

Preventive fire protection according to DIN 18234: Prevents fire spreading on the roof without additional measures

Use as a smoke outlet in stairwells

High hail resistance due to standard TSG outer pane



LAMILUX

GLASS SKYLIGHT FE 3°

The LAMILUX Glass Skylight FE 3° is an attractive individual element for the flat roof. It creates all aspects of modern, energy-efficient and design-oriented construction and achieves sophisticated architectural ideas. Additional accessories such as sun protection or shading roller blinds are also available with this system, which can be integrated in both residential and commercial buildings.

Water and dirt run off naturally on the 3° inclined upper part with a stepless transition between the frame profile and glazing. The complete system, which is free of thermal bridges, has core insulation in the frame profile as well as glazing with a warm edge design, thus ensuring high energy efficiency. The outstanding certified air tightness of the skylight is achieved by a double seal.

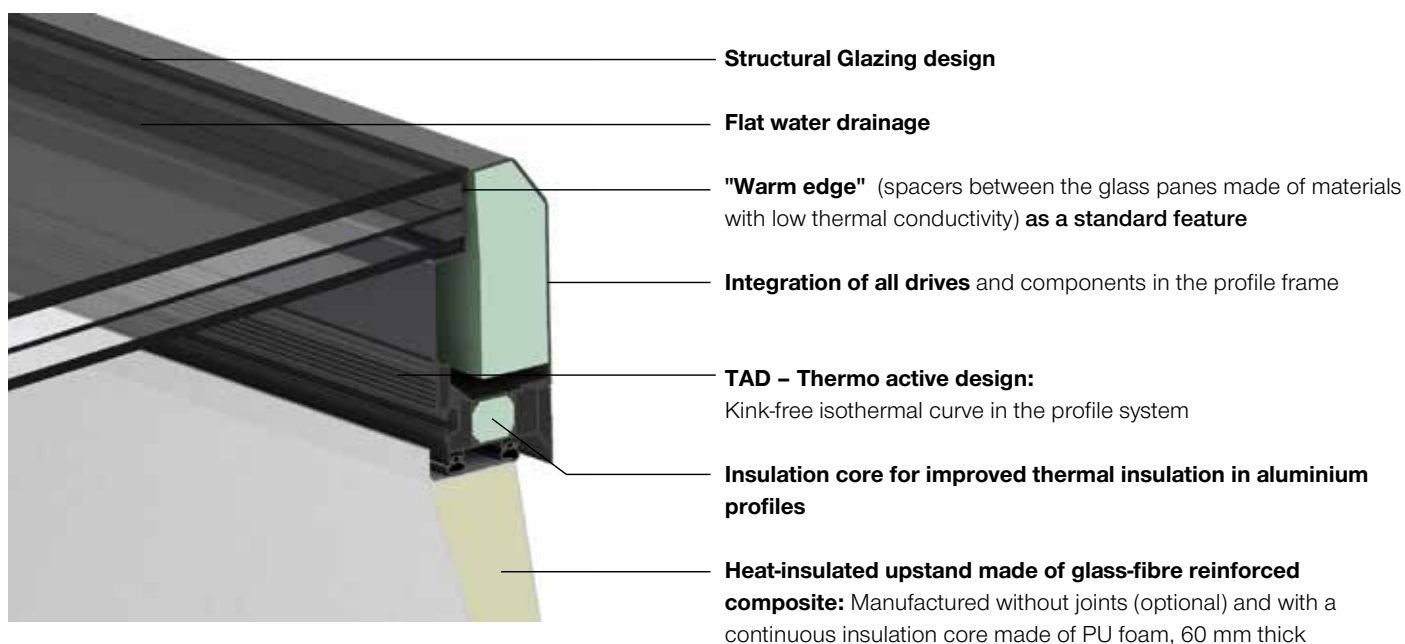



LAMILUX

GLASS SKYLIGHT FE CIRCULAR

The LAMILUX Glass Skylight FE Circular stands for high aesthetic demands. The daylight element meets the highest expectations for the modern design of buildings both in administrative buildings and in private residential and house construction. And the energetic qualities are also convincing, as are the high-grade workmanship and the high incidence of daylight.

The round, elegant frame profile is smooth and works without joints and can be coated in all customer-specific colours according to the RAL scale. The LAMILUX Glass Skylight FE Circular is the perfect daylight system where round shapes and high-quality materials enhance the overall visual impression of a building.

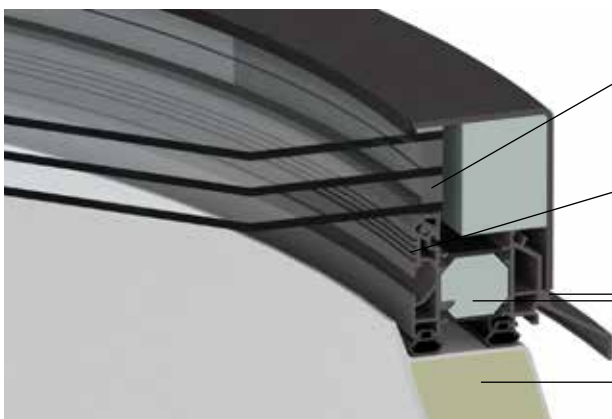

"Warm edge" (spacers between the panes, made of materials with low thermal conductivity) **as a standard feature**

TAD – Thermo active design:

Kink-free isothermal curve in the profile system

Aluminium border frame with optimised insulation core

Heat-insulated upstand made of glass-fibre reinforced composite: Manufactured without joints (optional) and with a continuous insulation core made of PU foam, 50 mm thick



LAMILUX

GLASS SKYLIGHT FE PYRAMID/HIPPED

These pyramid-shaped or hipped roof-shaped skylights enhance your flat roof visually not only through their striking shapes, but also through their delicate design from inside and outside - also thanks to elegant, narrow cross-bar profiles.

The flat roof skylights do not require visible screw connections and can be individually designed in their dimensions. The same applies to the colours of the surrounding profiles, which can be adapted to the overall concept of the building.



Thermal or solar protection insulated glazing with overlap glazing

"Warm edge" (spacers between the panes, made of materials with low thermal conductivity) **as a standard feature**

TAD – Thermo active design:
Kink-free isothermal curve in the profile system

Thermally optimised insulation core

Heat-insulated upstand made of glass-fibre reinforced composite: Manufactured without joints (optional) and with a continuous insulation core made of PU foam, 60 mm thick



LAMILUX

GLASS SKYLIGHT FE PASSIVHAUS

The energetic qualities of building products are the measure of all things in modern building. The Passive House demands the highest standard here – and the LAMILUX Glass Skylight FE Passivhaus and LAMILUX Glass Skylight FE Passivhaus+ are the world's first skylights at this energy efficiency level to be certified by the Passive House institute in Darmstadt.

Not least because of its triple step sealing system, its optimised insulation core and the warm edge with super spacer in the standard triple glazing or optional quadruple glazing, it fulfils the highest Passive House efficiency class: phA advanced component. The special feature is its heat transfer coefficient USL of 0.68 W/(m²K). Further advantages are high solar heat gains with simultaneously minimised condensate risk. The LAMILUX Glass Skylight FE Passivhaus+ meets the criteria for the "cold" climate region and is therefore the first skylight in the world to be suitable for passive houses in Scandinavia as well as in many regions of Austria, Switzerland and Eastern Europe.

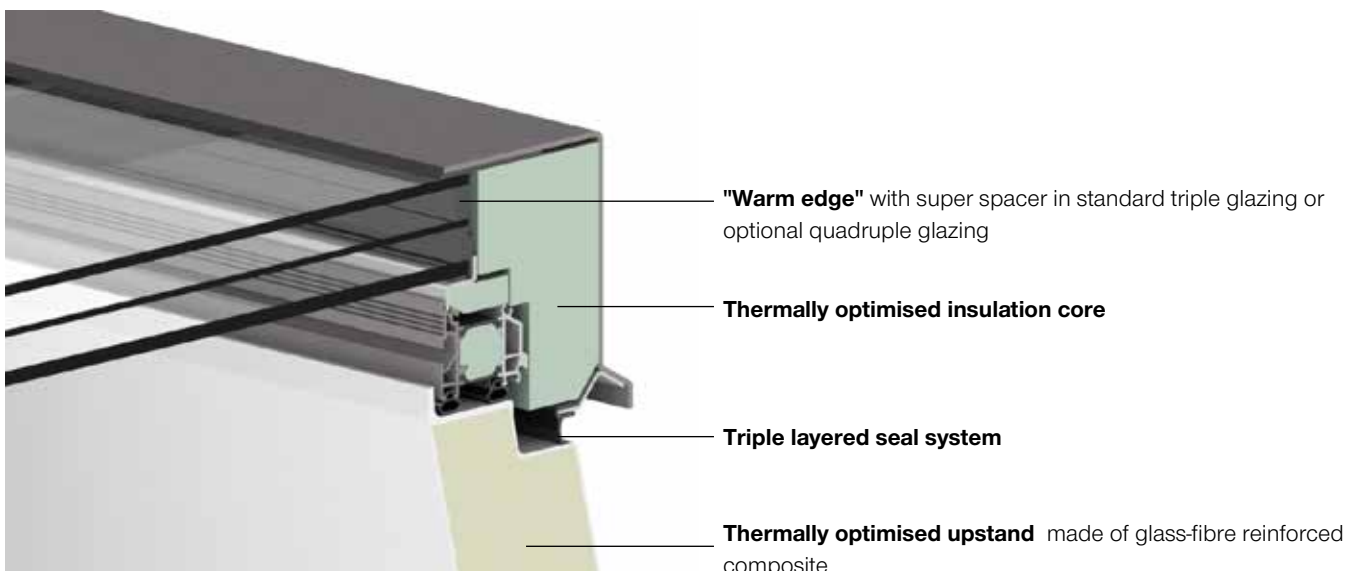



LAMILUX

FLAT ROOF EXIT COMFORT

What for some is the garden, for others is their roof terrace – at best with a direct and comfortable access. LAMILUX Flat Roof Exit Comforts offer a new dimension of roof access. For exclusive attic apartments, this creates a previously unattained incidence of light and even more convenient access to the roof.

The room climate also benefits from the high energy efficiency of the systems and their unlimited use as ventilation devices. The LAMILUX Flat Roof Exit Comforts are delivered completely pre-assembled to the upstand, lifted onto the roof by means of a crane provided by the customer and then installed very easily and quickly.



LAMILUX Flat Roof Exit Comfort Swing

The LAMILUX Flat Roof Exit Comfort Swing opens its 300 or 350 cm long glass element by key switch hydraulically. Like a horizontal door, the exit folds open and gives a 100 cm wide path to the roof. This saves rare space on the terrace and also goes quite swiftly: only about 25 seconds are needed for the element to open by 84 degrees. The 5° inclination ensures an ideal self-cleaning effect. The flat roof exit received a “special mention award” in the 2020 German Design Awards.



LAMILUX Flat Roof Exit Comfort Solo

Here the flat skylight measuring 120 x 350 cm opens horizontally by a built-in rack drive. This creates an even more comfortable access to the roof. The indoor climate also benefits from the high energy efficiency of the system as well as triple glazing. Thanks to the self-cleaning effect of the 6° inclination and the concealed drive units, the roof exit hatch is permanently attractive. The flat roof exit received the German Design Award in the category Special Mention in 2017.



LAMILUX Flat Roof Exit Comfort Duo

A special version of the roof exit hatch is the 2-leaf roof exit hatch. This opens two leaves of 60 x 300 cm each to the long sides. This 2-leaf roof hatch can also be fitted with functional glazing and can be used without limitation as a ventilation system. The element has no unsightly edges or visible drive units on the inside and ensures very good heat insulation.



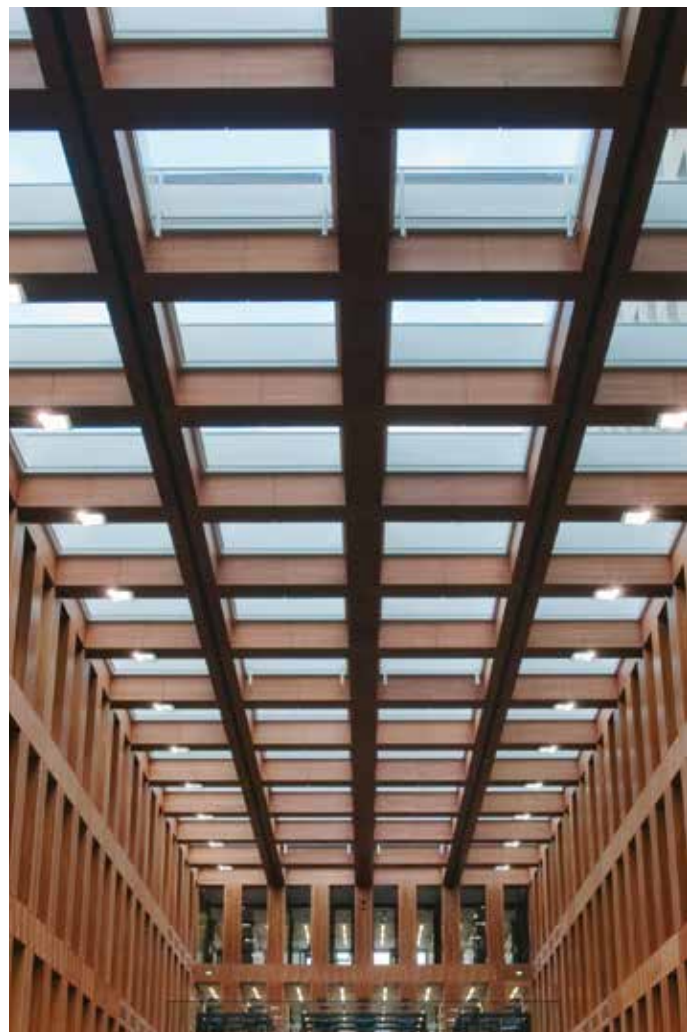

APARTMENT, BERLIN

Project:

Creation of a luxury living space with an exclusive ambience thanks to generous daylight intake, controllable ventilation and convenient access to the roof terrace

Systems:

- One LAMILUX Flat Roof Exit Comfort Duo, horizontally opening flat roof element (automatic opening and closing)
- Compact, extremely energy-efficient overall structure, placed on a glass-fibre reinforced composite upstand with an integrated core insulation block
- Low-noise sliding on stainless steel telescopic rails

HUMBOLDT UNIVERSITY, BERLIN

Project:

Large-area, natural illumination of the central library and reading area of the new building with high demands on the thermal insulation of the daylight systems

Systems:

- 92 LAMILUX Glass Skylight FE 3° elements, dimensions 250 x 250 cm
- Design partly as natural aeration and ventilation and with SHEV function
- Upstand structures made of glass-fibre reinforced composite with inside trimming made of coated sheet steel
- Sun protection glazing with 50% light transmittance and 17% energy transmission



NORRKÖPING SCHOOL, SWEDEN

Project:

Conversion of a former industrial building into a school building; Supply of the building with natural daylight even on cloudy winter days

Systems:

- LAMILUX Glass Skylight FE Pyramid in the dimensions 180 x 180 cm with a Ug value of 1.1 W/(m²K) and a sound insulation value of 35 dB
- Upstands made of glass-fibre reinforced composite, 50 cm in height
- Condensate detector



MILTON KEYNES UNIVERSITY HOSPITAL, ENGLAND

Project:

New construction of an administration building with a focus on aesthetic, natural lighting

Systems:







- 17 LAMILUX Smoke Lift Glass Skylight F100
- Six LAMILUX Glass Skylights FE Circular in ventilated design
- Six motors in special design for Glass Skylights
- Wind and rain sensor set
- SHEV central units and CO₂ alarm stations

LAMILUX GLASS SKYLIGHT F100 & SMOKE LIFT GLASS SKYLIGHT FE

The LAMILUX Smoke Lift Flat Glass Skylight F100 and LAMILUX Smoke Lift Glass Skylight FE offer new architectural possibilities for high-quality administrative buildings. It combines the advantages of flat roof skylights with those of an electrical smoke and heat exhaust ventilator according to DIN EN 12101-2.

It achieves excellent heat and sound insulation values and, in the case of the FE version, the aluminium frame can also be designed in freely selectable RAL colours. The natural smoke and heat exhaust ventilator offers you safety and comfort for your workspaces.

Temperature parameters according to DIN EN 12101-2 and test results Our NSHEVs reliably open into the SHEV position in less than 60 seconds...

	... and ensure high smoke discharge volumes	Flow rate coefficient C_v between 0.60 and 0.65; Aerodynamically effective opening surface A_a between 0.6 m ² and 2.84 m ² *
	... after endurance test – 1,000 times in SHEV position and 10,000 times in ventilation position	RE 1000 Ventilation 10,000
	... under snow load	SL 1000 to SL 2000
	... down to indoor temperature of -15 °C	T(-15)
	... after exposure to wind (up to 1500 N/m ²)	WL 1500
	... when exposed to fire	B 300

How your benefit

- Multi-stage ventilation fitted as standard
- Easy to close after false signal release
- Structure completely free of thermal bridges with a U_w value between 1.3 and 1.0 W/(m²K), depending on the glazing (as per DIN EN ISO 10077-1 for a reference element measuring 120 x 120 cm)
- Thermally insulated, joint-free GRP upstand, 30, 40 or 50cm in height, with U-values between 0.5 W/(m²K) and 0.9 W/(m²K)
- Complies with DIN 18234 requirements: Prevents fire spreading on the roof without additional measures
- Available as a roof exit hatch as an option
- Available with 24 V or 48 V drives

LAMILUX Smoke Lift Glass Skylight F100

- Permanent fall-through protection according to GS-Bau 18
- Available with double or triple insulating glazing with U_g values between 1.1 and 0.7 W/(m²K)
- Hard roofing, no burning droplets

LAMILUX Smoke Lift Glass Skylight FE

- Tested fall-through protection and accessibility for cleaning and maintenance purposes according to DIN 18008-6
- Available with double or triple insulating glazing with U_g values between 1.1 and 0.6 W/(m²K)

*valid for F100 up to 1,42 m²



LAMILUX Smoke Lift Glass Skylight F100



LAMILUX Smoke Lift Glass Skylight FE

LAMILUX RENOVATION SOLUTIONS

Renovations can be carried out for a wide variety of reasons. For example, to replace a damaged upper part, to better insulate the roof or to improve the energy efficiency and appearance of flat skylights. LAMILUX offers made-to-order solutions for this – as well as for all other renovation cases.

This includes for example the renovation frame for easy replacement of skylights. If, in addition, an energetic renovation of the roof is carried out, this is usually accompanied by an increase in the roof structure. In this case, the additional extension elements are the right choice: Existing upstands can be easily extended with it. Thanks to the made-to-order renovation solutions, LAMILUX can extend any onsite upstand. Most importantly: Individual consultation in individual cases.

LAMILUX Glass Skylight F100 or LAMILUX Glass Skylight FE

LAMILUX flat roof window

optional extension element

renovation frame

Existing on-site upstand

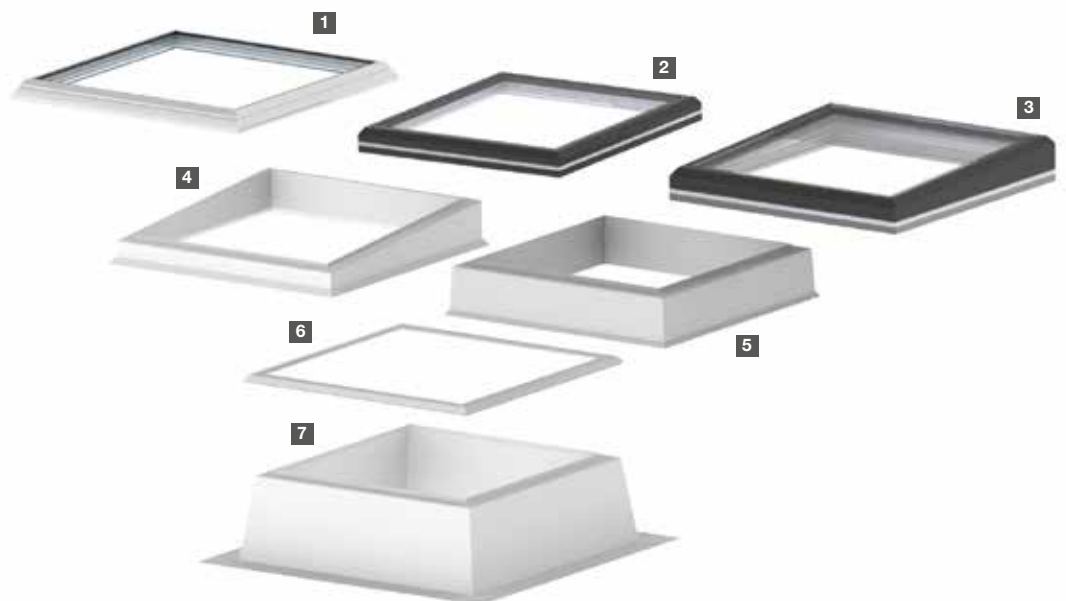

1 LAMILUX Glass Skylight F100

2 LAMILUX Glass Skylight FE

3 LAMILUX Glass Skylight FE 3°

4 GRP Heightening Element 5°

5 GRP Heightening Element

6 Renovation Frame 1 or 11

7 Existing on-site upstand

LAMILUX UPSTAND: IDEAL STRUCTURAL ATTACHMENT

The upstand is a key component in the whole LAMILUX flat skylight system. Constantly further developed in terms of stability and heat-insulating properties, the upstand forms the base for the structure. It provides a thermally optimum connection to the building structure.

Upstands are available in GRP (glass-fibre reinforced composite), aluminium and steel sheet.

A big advantage for the builder is the complete pre-assembly of the products we deliver. This saves time during installation on the roof and ensures fast closing of the roof opening. The LAMILUX GRP upstands also offer many options for customised roof mounts.



Heat-insulated base flange

The base flange made of glass-fibre reinforced composite and thermally insulated with PU foam is characterised by very good insulating properties and can be individually adapted to the height of the roof insulation. This upstand offers the possibility of connecting bitumen roofing membranes directly to the base flange in a system-compatible manner, so that time-consuming raising of the roofing membrane at the upstand is no longer necessary. The thermally insulated base flange is also available in combination with the rigid PVC connecting rail.



Hard PVC connecting rail

Hard PVC connecting rail is circumferentially laminated onto the base flange at the factory and seal-welded in the corners. This upstand offers the possibility of welding PVC roofing membranes directly to the PVC connecting rail at the base flange. In this way, a material-locking, all-round tight connection with the upstand is ensured. The rigid PVC connecting rail is also available without the thermally insulated base flange.

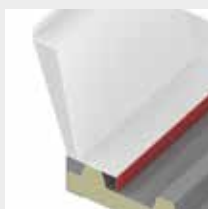

Bevelled base flange

A variant of the GRP skylight base with a base flange bevelled on both sides is available for structural attachment to profile roofs. For further requirements, e.g. on-site upstand, it is also available in a four-sided bevelled design.

Glazing types

Heat protection insulation glazing

F100



W102 DOUBLE TSG

Ug value: approx. 1,1 W/(m²K)
 Noise-proofing value: approx. 38 dB
 Translucency: approx. 80 %
 Energy transmission: approx. 57%



W701 TRIPLE TSG

Ug value: approx. 0,7 W/(m²K)
 Noise-proofing value: approx. 39 dB
 Translucency: approx. 72 %
 Energy transmission: approx. 51 %

Heat protection insulation glazing with matt, light-coloured film

F100



W103 DOUBLE TSG (MHF)

Ug value: approx. 1,1 W/(m²K)
 Noise-proofing value: approx. 38 dB
 Translucency: approx. 54 %
 Energy transmission: approx. 54 %



W702 TRIPLE TSG (MHF)

Ug value: about 0,7 W/(m²K)
 Noise-proofing value: approx. 39 dB
 Translucency: approx. 49 %
 Energy transmission: approx. 50 %

Solar protection insulation glazing

F100



S109 DOUBLE TSG, 60/30

Ug value: approx. 1,1 W/(m²K)
 Noise-proofing value: approx. 38 dB
 Translucency: approx. 61 %
 Energy transmission: approx. 30 %



S717 TRIPLE TSG, 60/30

Ug value: approx. 0,7 W/(m²K)
 Noise-proofing value: approx. 39 dB
 Translucency: approx. 55 %
 Energy transmission: approx. 28 %

Solar protection insulation glazing with matt, light-coloured film

F100

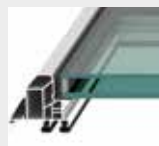

S110 DOUBLE TSG, 60/30 (MHF)

Ug value: approx. 1,1 W/(m²K)
 Noise-proofing value: approx. 38 dB
 Translucency: approx. 41 %
 Energy transmission: approx. 29 %

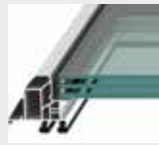

S718 TRIPLE TSG, 60/30 (MHF)

Ug value: approx. 0,7 W/(m²K)
 Noise-proofing value: approx. 39 dB
 Translucency: approx. 37 %
 Energy transmission: approx. 27 %

Heat protection insulation glazing

FE

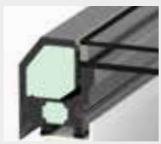

W102 DOUBLE TSG

Ug value: approx. 1,1 W/(m²K)
 Noise-proofing value: approx. 38 dB
 Translucency: approx. 80 %
 Energy transmission: approx. 62 %



W110 TRIPLE TSG

Ug value: approx. 0,6 W/(m²K)
 Noise-proofing value: approx. 39 dB
 Translucency: approx. 72 %
 Energy transmission: approx. 51 %

Heat protection insulation glazing with matt, light-coloured film

FE



W103 DOUBLE TSG (MHF)

Ug value: approx. 1,1 W/(m²K)
 Noise-proofing value: approx. 38 dB
 Translucency: approx. 54 %
 Energy transmission: approx. 59 %



W303 TRIPLE TSG (MHF)

Ug value: approx. 0,6 W/(m²K)
 Noise-proofing value: approx. 39 dB
 Translucency: approx. 49 %
 Energy transmission: approx. 50 %

Solar protection insulation glazing

FE

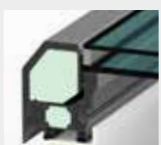

S109 DOUBLE 60/30 TSG

Ug value: approx. 1,1 W/(m²K)
 Noise-proofing value: approx. 38 dB
 Translucency: approx. 61 %
 Energy transmission: approx. 30 %

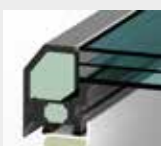

S117 TRIPLE 60/30 TSG

Ug value: approx. 0,6 W/(m²K)
 Noise-proofing value: approx. 39 dB
 Translucency: approx. 55 %
 Energy transmission: approx. 28 %

Solar protection insulation glazing with matt, light-coloured film

FE

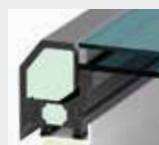

S101 DOUBLE 48/25 TSG

Ug value: approx. 1,1 W/(m²K)
 Noise-proofing value: approx. 38 dB
 Translucency: approx. 49 %
 Energy transmission: approx. 27 %



S121 TRIPLE 48/25 TSG

Ug value: approx. 0,6 W/(m²K)
 Noise-proofing value: approx. 39 dB
 Translucency: approx. 45 %
 Energy transmission: approx. 25 %

TSG: (toughened safety glass) Has increased shock and impact resistance due to special heat treatment in the manufacturing process. If broken, the glass will shatter into many small pieces without sharp edges, which reduces the risk of injury.

MHF: (Matt bright foil) By using an opal foil the incident light is scattered and a direct glare effect is avoided.

Opener variants

Chain drives



24 volt / 230 volt chain drive

- Voltage: 24 volt, 230 volt
- Lift heights: 300 mm, 500 mm



Concealed chain drive

- Voltage: 24 volt, 230 volt
- Lift heights: 250 mm, 300 mm
- Concealed installation integrated in upstand (Glass Skylight F100)
- Concealed installation in frame (with Glass Skylight FE version)

Linear drives



230 volt linear motor

- Voltage: 230 volt
- Lift heights: 300 mm, 500 mm



24 volt linear motor

- Voltage: 24 volt
- Lift heights: 300 mm, 500 mm

Hand crank



Manual opening

- Solo arrangement
- Hand crank for upstand spindle

Concealed cable duct



Integration

- Cable routing invisible from the inside integrated in the upstand

Accessories

Optional equipment



Reflective

- The light transmittance of the daylight element is increased by up to 50% due to the patented principle of cladding with highly reflective aluminium material
- Up to 33% savings in energy used for artificial light
- Elegant surface finish gives high-quality interior appearance



LED

- LEDs with high-quality daylight character
- Colour selection: Warm white 2700K, Neutral white 4000K
- Concealed cable routing in the upstand



Wind and rain sensor set

- For automatic closing in wind and rain
- Operated as a group and individually
- Pre-assembled at the factory on the border frame



Small space ventilation unit

- Option for LAMILUX-GFK upstands that are 30, 40 and 50 cm in overall height, incl. weather protection hood
- Not available for round design



Insect protecting grating

- Integration of the protective device into the upstand
- Close to complete prevention of insects entering the building



Reed contact

- Integration of the magnetic switch in the frame profile
- Signalling of the opening status by means of a contactless switching process



Roof exit

- Access from inside the building to the roof
- With gas springs or electric drive
- Optionally with lockable window handle or spring-loaded locking pin

Sun protection



Internal shadow film blind

- Integration on the underside of the upper part
- Pre-assembled at the factory
- White-coated mounting frame
- Concealed cable routing in the upstand



Internal film roller blind

- Integration on the underside of the upstand
- Version with safety pull straps
- Optionally with remote control
- White inside



External aluminium roller blind

- Optionally available with semi-transparent louvers
- Can be supplied in a variety of colours
- Optionally with integrated solar module and remote control

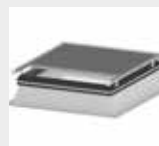

External awning

- With noise-optimised running-in gliders
- Optionally with remote control
- Concealed cable routing in the upstand

Accessories

Smoke extraction



LAMILUX SHEVS STAIRCASE SET

For ventilated flat roof windows consisting of:

- SHEV control unit with emergency power supply
- 24 volt drive with 500 mm lifting height
- Two SHEV buttons
- One fan button

Quality



- Outstanding air-tightness due to the double balloon-type seal: Performance class 4 – tested in accordance with DIN EN 12207
- Watertightness as per DIN EN 12208, Class E 1950
- High resistance to wind load according to EN 12211 class C 4 (for LAMILUX Glass Skylight F100) and class C 5 (for LAMILUX Glass Skylight FE)
- Passive fire protection: Compliance with DIN 18234 for the prevention of fire spread on rooftops without additional measures
- Resistance to external fire damage from flying sparks and radiating heat with classification B,roof(t1) according to DIN EN 13501-5
- Life-cycle assessment made easy: Comprehensive environmental product declaration according to ISO 14025 and EN 15804 (EPD - Modules A1 - D)

Available sizes

LAMILUX Glass Skylight F100



Top roof edge in cm	Standard position of lock	Daylight area \ lighting area in m ²	Top roof edge in cm	Standard position of lock	Daylight area \ lighting area in m ²
60 / 60		0,18	90 / 145		0,91
60 / 90		0,30	100 / 100		0,67
60 / 120		0,43	100 / 150		1,08
70 / 135		0,61	120 / 120		1,04
80 / 80		0,38	120 / 150		1,35
80 / 150		0,82	125 / 125		1,14
90 / 90		0,52	140 / 140		1,49
90 / 120		0,73	150 / 150		1,74

LAMILUX Glass Skylight F100 Circular

Diameter in cm	Daylight area \ lighting area in m ²	Diameter in cm	Daylight area \ lighting area in m ²
60	0,23	120	0,82
80	0,30	150	1,37
90	0,41	180	2,06
100	0,53		

Available sizes

LAMILUX Glass Skylight FE and LAMILUX Glass Skylight FE 3° | Pyramid | Hipped













Top roof edge in cm	Standard position of lock	Daylight area\ lighting area in m ²	Top roof edge in cm	Standard position of lock	Daylight area\ lighting area in m ²
50/100		0,26	120/240		2,26
50/150		0,42	120/250		2,37
60/60		0,18	120/270		1,14
60/90		0,30	125/125		2,48
60/120		0,43	125/250		1,49
70/135		0,61	140/140		2,88
80/80		0,38	150/150		1,74
80/150		0,82	150/180		2,14
90/90		0,52	150/200		2,40
90/120		0,73	150/210		2,53
90/145		0,91	150/240		2,93
100/100		0,67	150/250		3,06
100/150		1,08	150/270		3,33
100/200		1,49	150/300		3,72
100/240		1,82	180/180		2,62
100/250		1,90	180/240*		3,60
100/300		2,31	180/250*		3,76
120/120		1,04	200/200		3,31
120/150		1,35	250/250*	—	5,38
120/180		1,65			

*only for LAMILUX Glass Skylight FE

LAMILUX Glass Skylight F100 Circular

Diameter in cm	Daylight area\ lighting area in m ²	Diameter in cm	Daylight area\ lighting area in m ²
90	0,41	180	2,06
100	0,53	200	2,60
120	0,82	220	3,20
150	1,37		

LAMILUX Roof Exit Hatch

Top roof edge in cm	Standard position of lock	Daylight area \ lighting area in m ²	Top roof edge in cm	Standard position of lock	Daylight area \ lighting area in m ²
60 / 90		0,30	90 / 120		0,73
60 / 120		0,43	90 / 145		0,91
70 / 135		0,61	100 / 100		0,67
80 / 80		0,38	100 / 150		1,08
80 / 150		0,82	120 / 120		1,04
90 / 90		0,52	120 / 150		1,35

LAMILUX Smoke Lift Glass Skylight F100

Top roof edge in cm	Aa value in m ²	Top roof edge in cm	Aa value in m ²
100/100	0,60	125/125	0,97
100/150	0,90	150/150*	1,42
120/120	0,88	150/150**	1,35
120/150	1,12		

* for double glazing

** for triple glazing

LAMILUX Smoke Lift Glass Skylight FE 0° | 3°

Top roof edge in cm	Aa value in m ²	Top roof edge in cm	Aa value in m ²
100/100	0,60	120/250	1,86
100/150	0,90	120/300	2,23
100/200*	1,24	125/125	0,97
100/200**	1,20	125/250	1,94
100/240	1,44	150/150*	1,42
100/250	1,53	150/150**	1,35
100/300	1,83	150/180	1,65
120/120	0,88	150/200	1,86
120/150	1,12	150/210	1,98
120/180*	1,36	150/240	2,27
120/180**	1,30	150/250	2,36
120/240	1,79	150/300	2,84

* for double glazing

** for triple glazing



Scan this to discover more about
LAMILUX daylight systems!



ROOFLIGHT F100



GLASS SKYLIGHT F100



GLASS SKYLIGHT FE



GLASS ARCHITECTURE



RENOVATION



MIROTEC STEEL CONSTRUCTIONS



CONTINUOUS ROOFLIGHT B



CONTINUOUS ROOFLIGHT S



CONTINUOUS ROOFLIGHT W|R



SMOKE AND HEAT EXHAUST
VENTILATION SYSTEMS



BUILDING CONTROL SYSTEMS



RODA LIGHT AND AIR TECHNOLOGY

The technical data printed in this brochure was accurate when this brochure went to press and is subject to change without notice. Our technical specifications are based on calculations and supplier specifications, or have been determined by independent testing authorities within the scope of applicable standards.

Thermal transmission coefficients for our composite glazing were calculated using the finite element method with reference values in accordance with DIN EN 673 for insulated glass. Based on empirical values and specific characteristics of the plastics, a temperature vector of 15 K was defined as the vector between the outer surfaces of the material. Functional values refer to test specimens and the dimensions used in testing only. We cannot provide any further guarantees of technical values. This particularly applies to changes in installation locations, or if dimensions are re-measured on site.



LAMILUX Heinrich Strunz GmbH

Zehstraße 2 · PO Box 1540 · 95111 Rehau · Tel.: +49 (0) 92 83 / 5 95-0 · Fax +49 (0) 92 83 / 5 95-29 0

E-Mail: information@lamilux.de · www.lamilux.com

