

# Eezi-Awn

# 1000

## OPERATING INSTRUCTIONS

P.O. Box 68323, Bryanston 2021.  
14 Susan Street, Strydompark, Randburg,  
South Africa.  
Tel: (011) 792-1731  
Fax: (011) 791-0727

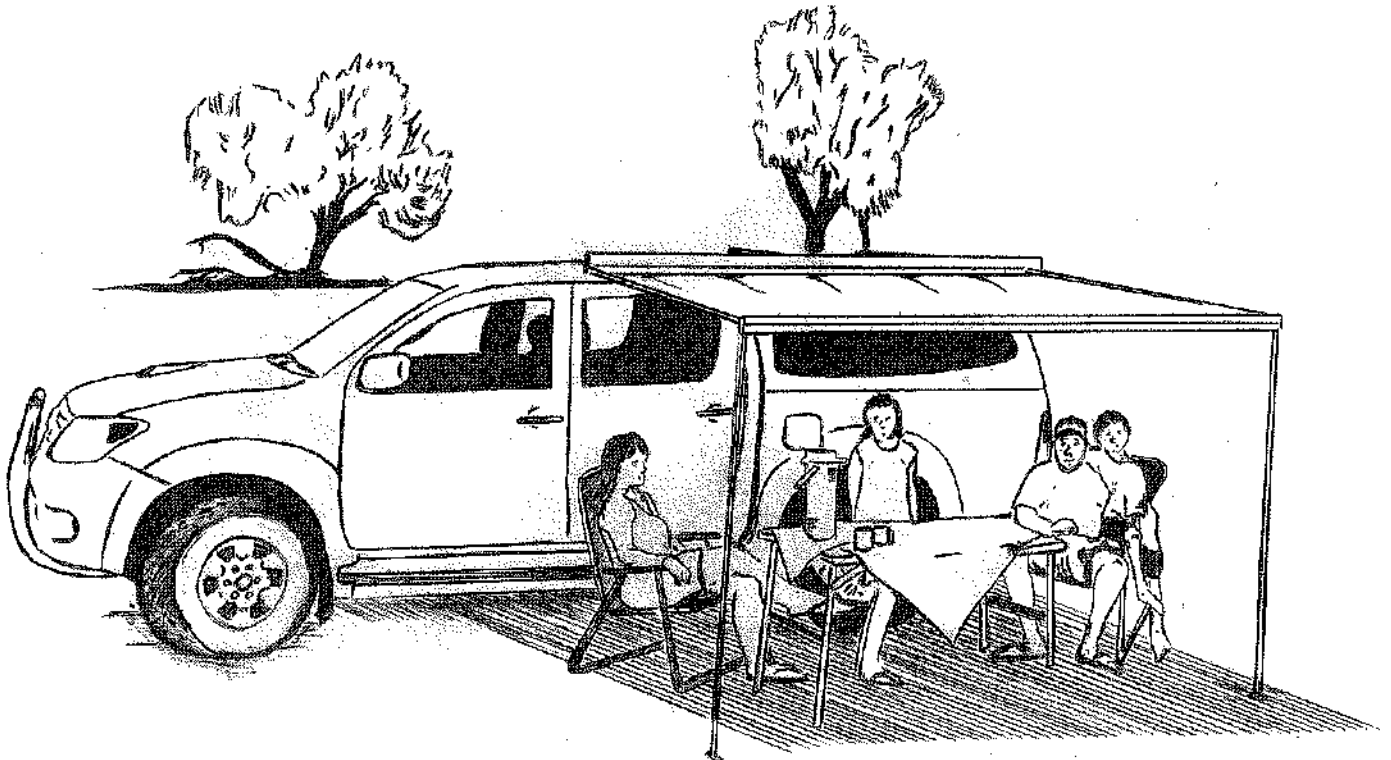

## HELPFUL HINTS

1. Periodically clean the fabric with any detergent. (Let the fabric dry before rolling it up. This also helps prevent mildew.)  
Cleaning is especially important prior to storing the awning for long periods of time to prevent mildew and stains.
2. Use paraffin wax on Support Arms and Rafter Arms for smoother sliding movement.



P.O. Box 68323, Bryanston 2021.  
 14 Susan Street, Strydompark, Randburg,  
 South Africa.  
 Tel: (011) 792-1731  
 Fax: (011) 791-0727

## INSTALLATION VAN ADAPTOR KIT

**Application:** For use on **EEZI-AWN 1000** for temporary or permanent mounting without drilling holes on the vehicle.

**IMPORTANT:** Read all of the following steps before beginning installation.

• **EEZI-AWN** reserves the right to modify appearances and specifications without notice.

1. Locate and position two Adapter Brackets on the rain gutter as shown in Figure 1.

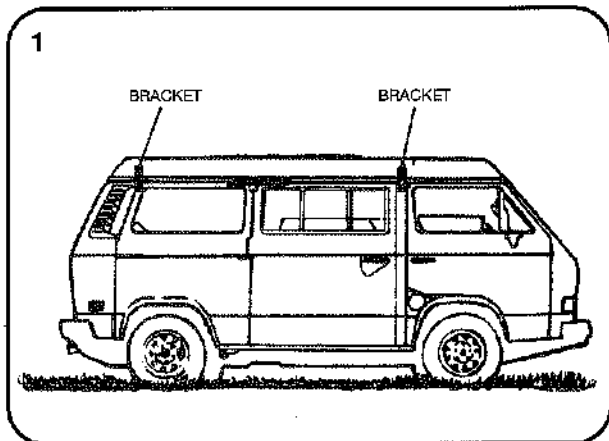

The Brackets must be positioned so as not to interfere with the passenger door, sliding door or swing-out door.

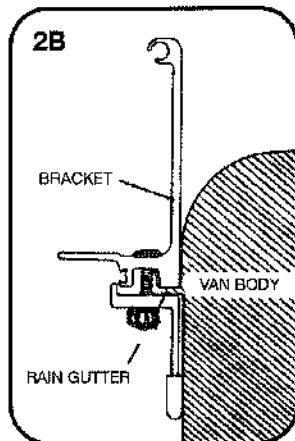
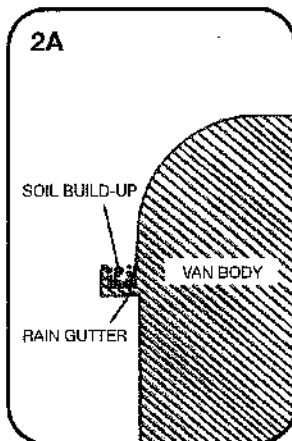

2. Before proceeding on to Step 3 check rain gutter for possible soil build-up by running your finger along the inside of the rain gutter. (Fig. 2A) All build-up must be cleaned out for the Mounting Bracket to fit properly. (Fig. 2B)

3. After Brackets are in place on the van, slide Awning Case onto Brackets and into desired position.

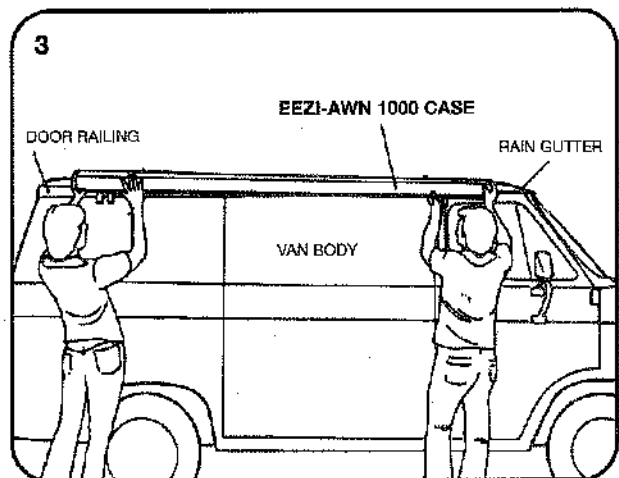

4. Prevent the Case from shifting or sliding back and forth by completing the following steps. Using a 4mm drill bit, drill a hole into the Case, to correspond with the hole in the front Mounting Bracket. (Fig. 5)

**WARNING: Awning Fabric MUST be removed before drilling to prevent damage to the Fabric.**

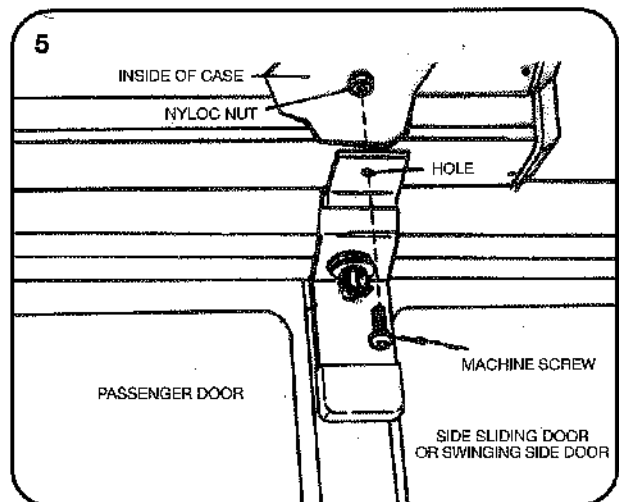

Insert the Machine screw through the holes in the Bracket and Case and secure with the Nyloc Nut on the inside.

5. Awning is now ready for use.

# TO OPEN

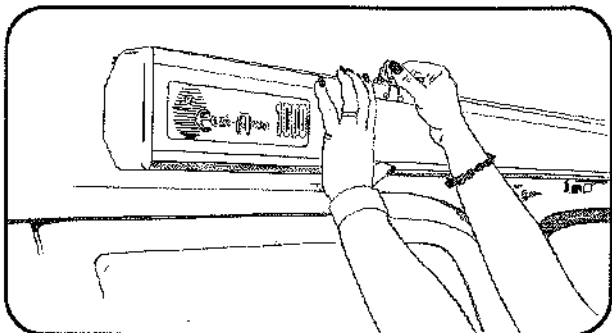

Undo the latches and open the EEZI-AWN.

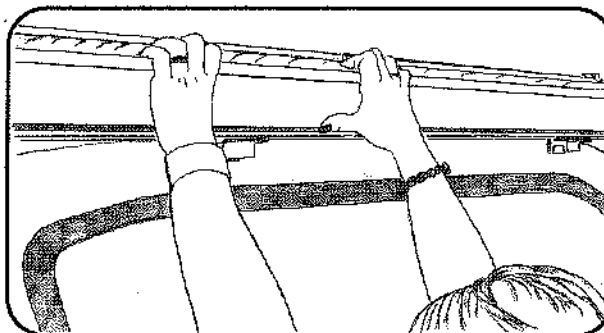

Pull down on casing lid to unfold fabric.

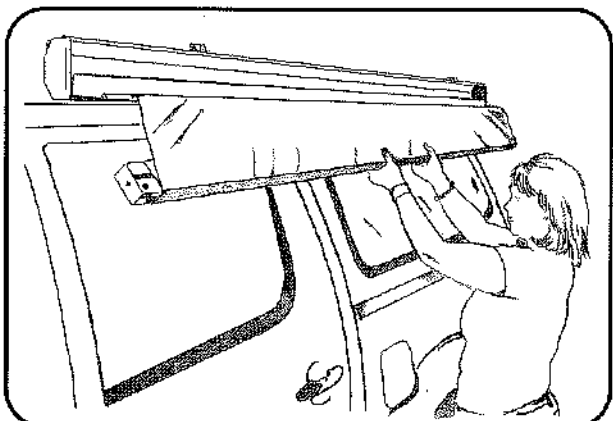

Roll fabric out of EEZI-AWN by holding front profile in the middle and walk backwards.

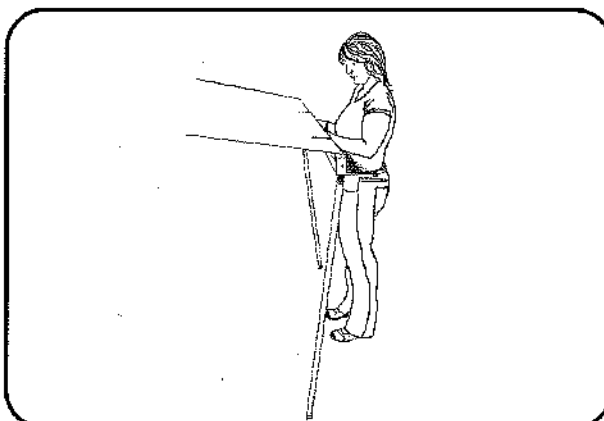

When the EEZI-AWN fabric is fully unrolled hold arms in front profile and let legs drop to the ground.

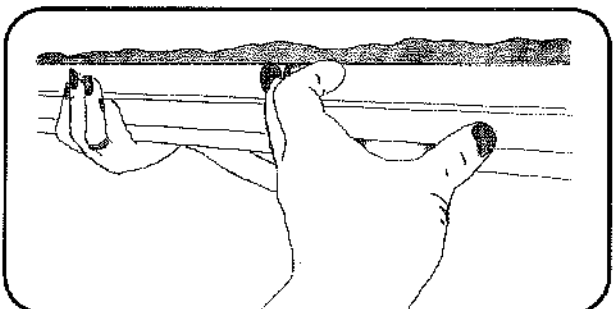

Reach in and pull arms out.

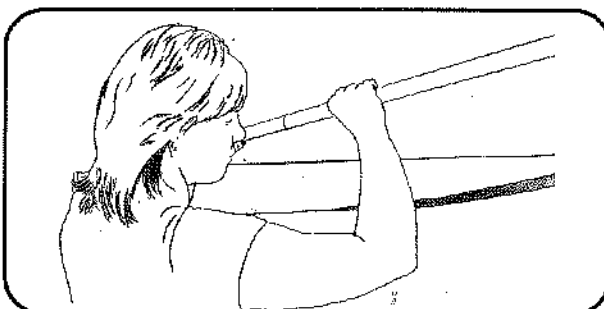

Take left and right arm, fully extend them, twist to lock in place.

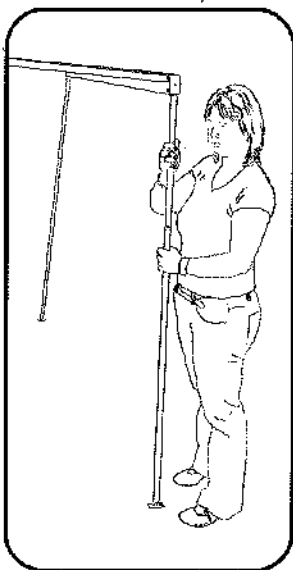

Extend legs to height required and twist to lock in place.

**NB.** Should it rain, drop one leg in order for water to run off EEZI-AWN.

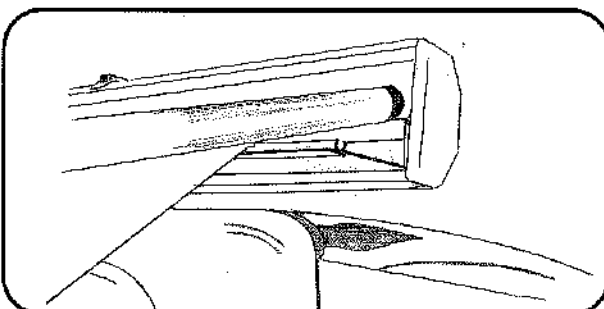
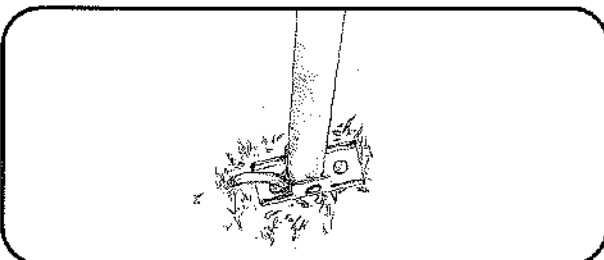
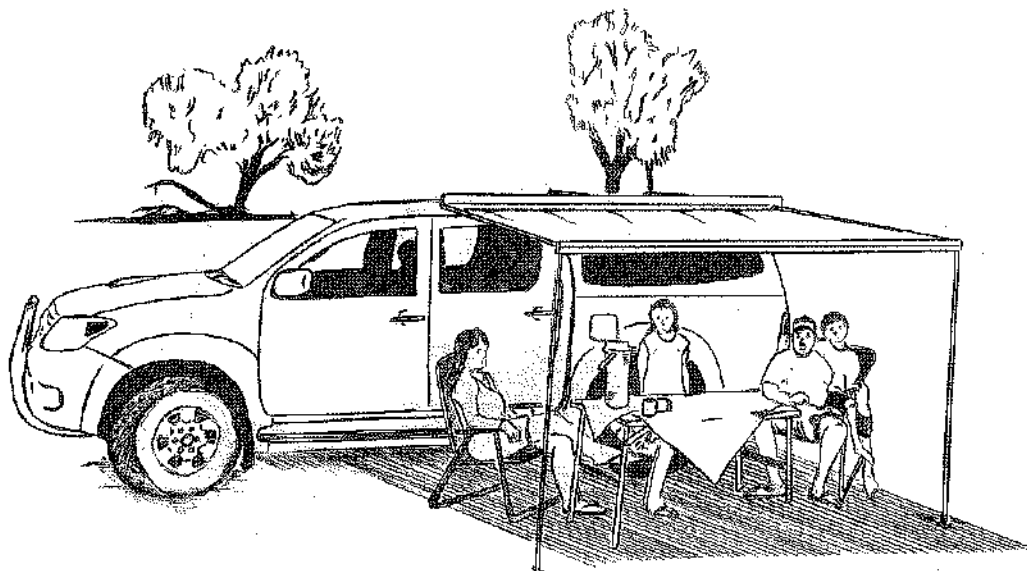

Diagram shows arm supported in back of casing.



Peg the swivel foot to the ground to secure the EEZI-AWN.



## TO CLOSE

RELAX AND ENJOY!!!

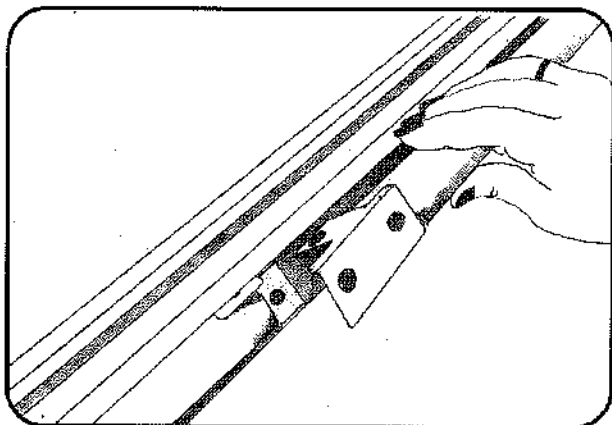

When folding legs back into front profile make sure that one foot faces up and one foot faces down.

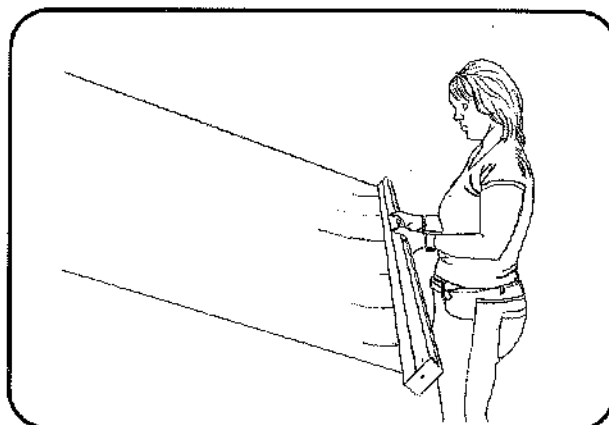

**NB. Twist Lock arms and legs before closing the EEZI-AWN.** Hold front profile in middle and roll up EEZI-AWN fabric in a anti clockwise direction in order to close.

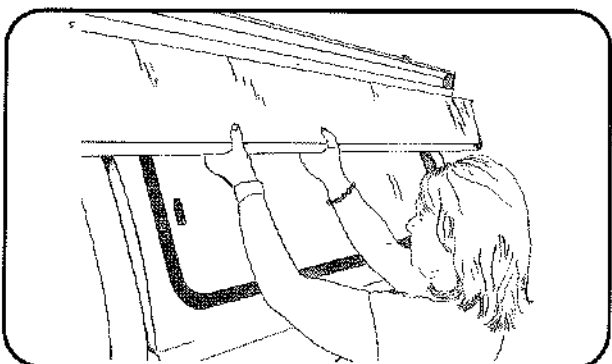

The fabric should be rolled back to the casing and flipped onto the casing cover.

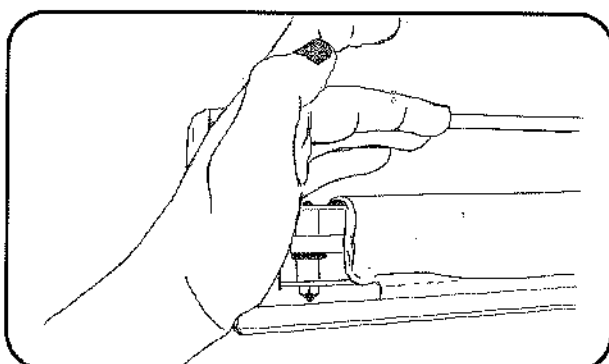

If the fabric has been rolled skew, this can be realigned by pushing one side.

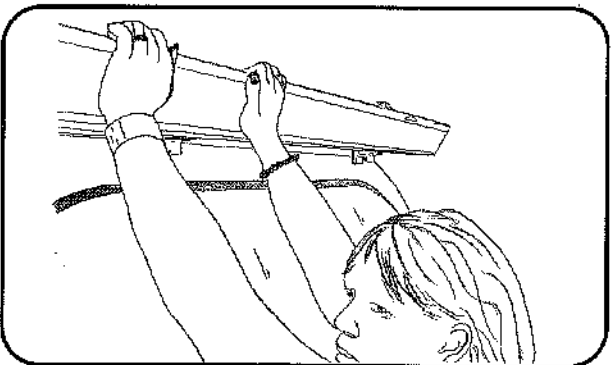

Close EEZI-AWN casing cover and secure clips.

