

**COMPETITOR SERIES®**

**C-1FB-HC**

**C-2FB-HC**

**C-3FB-HC**

# BOTTOM MOUNT REACH-IN FREEZERS

- Beautiful ergonomic construction & rounded corners
- Digital temperature controller & read-out
- All stainless steel exterior and interior
- Forced air refrigeration system
- Recessed door handles
- LED Interior Lighting
- Door locks
- 90 degree hold open door feature for loading products
- Migali® Protection Plan: 2 Year Parts & Labor Warranty, 5 Years Compressor Warranty
- Bottom mount compressor for enhanced efficiency
- Pre-installed casters and shelving
- Auto-defrost
- Air plenum across back wall for even temperature distribution throughout cabinet interior
- All Natural R290 Hydrocarbon Refrigerant
- US Department of Energy Certified
- Air Pressure Relief Valve for ease of opening doors

MODEL	DOORS	CAPACITY CU/FT	SHELVES	H/P	AMPS	VOLTAGE	ENERGY CONSUMPTION KWH/24 HR	PLUG TYPE	TEMP RANGE	EXTERIOR DIMENSIONS W X D X H*	INTERIOR DIMENSIONS W X D X H	PACKAGED DIMENSIONS W X D X H	WEIGHT	PACKAGED WEIGHT
C-1FB-HC	1	19.1	3	1/2	6.3	115/60/1	4.36	Nema 5-15P	-10° F (~) 0° F	27 x 31.5 x 83.1	22.25 x 26.1 x 60	29 x 33.5 x 86.2	264 lbs.	297 lbs.
C-2FB-HC	2	44.7	6	3/4+	8.6	115/60/1	7.82	Nema 5-15P	-10° F (~) 0° F	54.4 x 31.5 x 83.1	49.7 x 26.1 x 60	56.4 x 33.5 x 86.2	410 lbs.	465 lbs.
C-3FB-HC	3	68	9	1	6.2	208-230/115/60/1	14.67	Nema L14-20P	-10° F (~) 0° F	81.9 x 31.5 x 83.1	77.2 x 26.1 x 60	83.9 x 33.5 x 86.2	551 lbs.	628 lbs.

\* Total height includes casters

**FOR COMMERCIAL USE ONLY**

NOTE: MIGALI® RESERVES THE RIGHT TO CHANGE SPECIFICATIONS WITHOUT NOTICE



TOLL FREE: 800.852.5292  
WEB: www.migali.com



# DIMENSIONAL DRAWINGS

C-1FB-HC

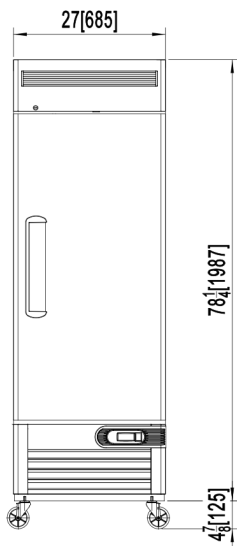

C-2FB-HC

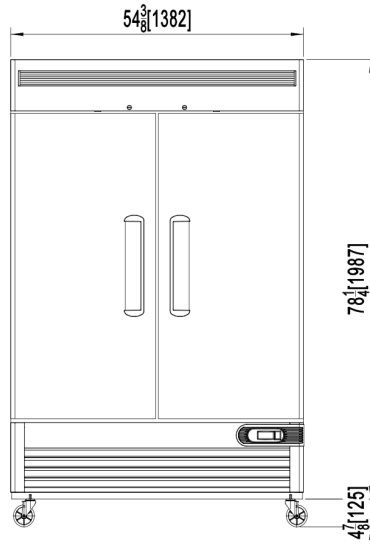

C-3FB-HC

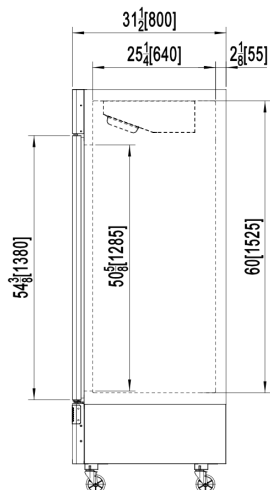
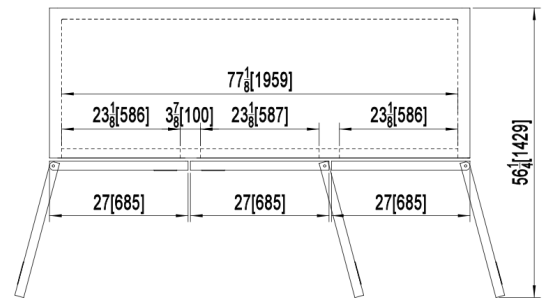
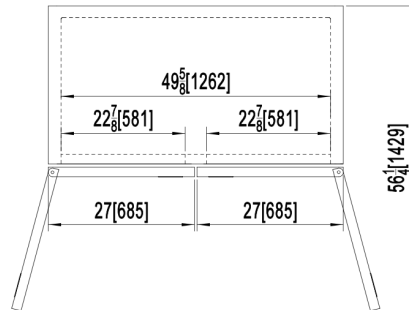
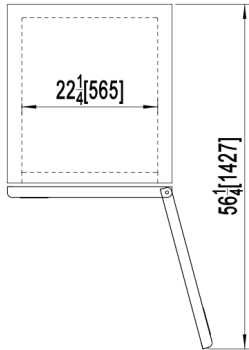
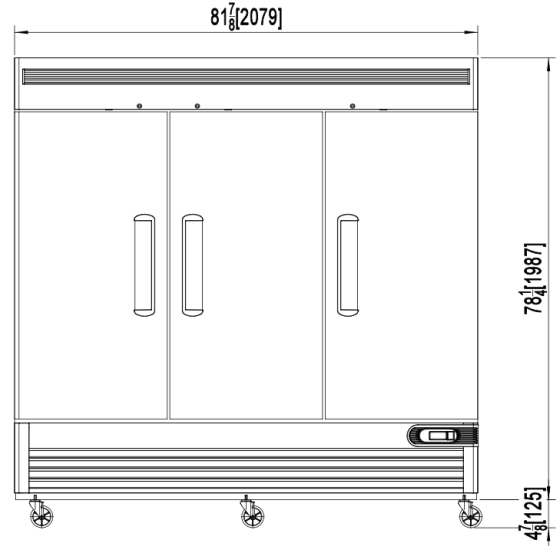

SIDE VIEW (1,2,3) DOOR MODELS



MIGALI® REMAINS AN AMERICAN FAMILY COMPANY SINCE 1955