

COMPETITOR SERIES®

C-PP44-HC

C-PP67-HC

C-PP93-HC

PIZZA PREPARATION TABLES

- Beautiful ergonomic construction & rounded corners
- Digital temperature controller and read-out
- All stainless steel exterior and interior
- Forced air refrigeration system
- Side mount compressor for enhanced efficiency
- 19^{1/2}" deep cutting board included
- Recessed door handles
- Pre-installed casters and shelving
- 90 degree hold open door feature for loading products
- All Natural R290 Hydrocarbon Refrigerant
- US Department of Energy Certified
- Rail accommodates 4" deep pans
- Insulated lids help ensure food products in rail stay cold
- Migali® Protection Plan: 2 Year Parts & Labor Warranty, 5 Years Compressor Warranty

MODEL	DOORS	NUM. OF (1/3) SIZE PANS*	CAPACITY CU/FT	SHELVES	H/P	AMPS	VOLTAGE	ENERGY CONSUMPTION KWH/24 HR	PLUG TYPE	TEMP RANGE	EXTERIOR DIMENSIONS W X D X H**	INTERIOR DIMENSIONS W X D X H	PACKAGED DIMENSIONS W X D X H**	WEIGHT	PACKAGED WEIGHT
C-PP44-HC	1	6	14	1	1/7+	2.3	115/60/1	1.5	Nema 5-15P	+33° F (~) +41° F	44 x 33 x 43.4	40.4 x 26.4 x 26.3	47 x 35 x 46	238 lbs.	295 lbs.
C-PP67-HC	2	9	20	2	1/5	2.8	115/60/1	2.1	Nema 5-15P	+33° F (~) +41° F	67 x 33 x 43.4	63.5 x 26.4 x 26.3	68 x 35 x 46	335 lbs.	405 lbs.
C-PP93-HC	3	12	26	3	1/4+	3.1	115/60/1	2.6	Nema 5-15P	+33° F (~) +41° F	93 x 33 x 43.4	89.4 x 26.4 x 26.3	95 x 35 x 46	427 lbs.	527 lbs.

* Pans are not included

** Height is measured floor to the top of the pan rail and include 6" casters

NOTE: MIGALI® RESERVES THE RIGHT TO CHANGE SPECIFICATIONS WITHOUT NOTICE



TOLL FREE: 800.852.5292
WEB: www.migali.com



DIMENSIONAL DRAWINGS

C-PP44-HC

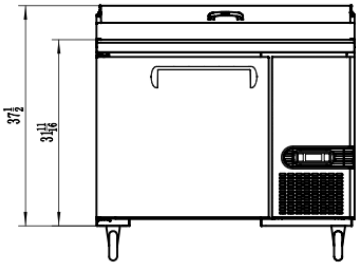

C-PP67-HC

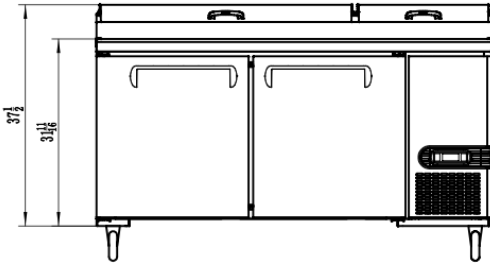

C-PP93-HC

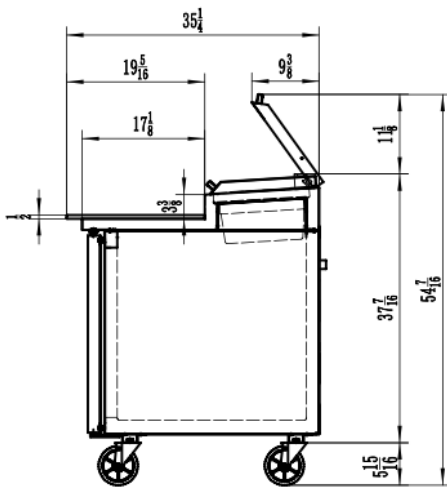
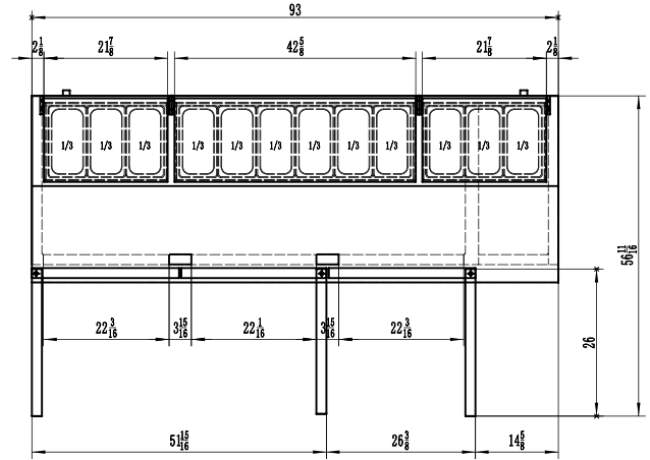
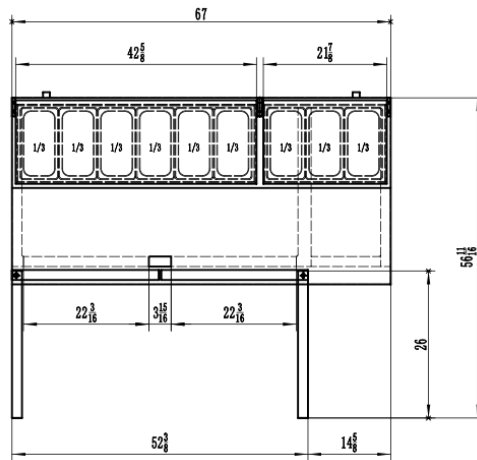
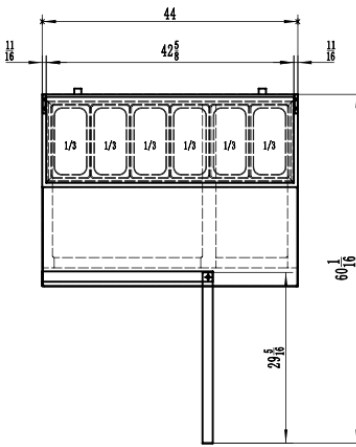
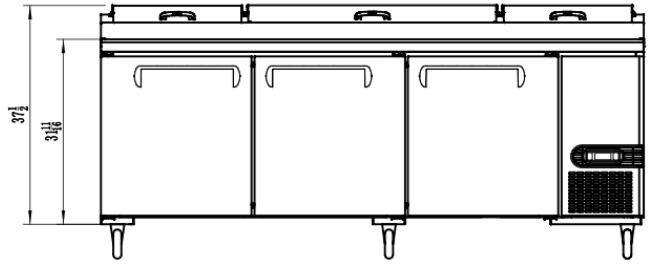

SIDE VIEW (1,2,3) DOOR MODELS



MIGALI® REMAINS AN AMERICAN FAMILY COMPANY SINCE 1955