

# DC3000A

# d'Action 360

## d'Action 360 Instruction Manual

Using this Product Safely

Preparation

Installation

Capturing Images/Video

Viewing/Deleting Media

Changing Camera Settings

Troubleshooting

For Americas :  
Car Mate USA, Inc.  
383 Van Ness Avenue, Suite 1603  
Torrance, CA 90501, USA  
info@carmate-usa.com  
310-533-4963 (FAX)  
http://www.carmate-usa.com

For other countries :  
**CAR MATE MFG. CO., LTD.**  
5-33-11, Nagasaki, Toshima-ku,  
Tokyo 171-0051, Japan  
int@carmate.co.jp  
http://www.carmate.co.jp/english

Firmware Ver. 2.0.2  
(as of Aug. 2018)

# Introduction

## About this manual

Thank you for purchasing d'Action 360.

This instruction manual is your guide book to using d'Action 360 (hereinafter "Product").

To use this Product properly and safely, please read and understand the contents of this manual prior to use.

After reading, please keep this manual nearby for future reference or troubleshooting.

If you give this Product to somebody else, please include this manual as well.



## Disclaimer

Please note that Car Mate takes no responsibility for any loss arising from the use or failure of this Product or from any damage to any recorded video and/or data.

# d'Action 360 features

This Product is a smartphone-linked, car-mounted camera, with a 360-degree panoramic view, allowing you to record any and all of the scenes encountered during your time on the road. Captured videos and still images can be downloaded straight to your smartphone on the spot, making playback and sharing possible both anytime and anywhere.



This Product also features three operational modes. By purchasing add-on products separately, you can utilize these modes for a wider range of purposes.

### Driving Mode

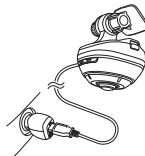

In Driving Mode, the camera installed in your car captures both the inside of the car and the outside simultaneously. In addition to acting as a standard dashboard camera, d'Action 360 is able to simultaneously record both the road around you, and scenes from inside the vehicle. The camera automatically begins operation in Driving mode when power is supplied via your car's cigarette lighter receptacle.

### Action Mode

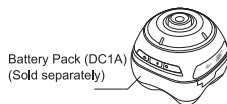

Battery Pack (DC1A)  
(Sold separately)

\*Battery Option (DC100A) is required. (Sold separately)  
Action Mode allows you to record your surroundings by taking the camera outside of your car. Just as if it were a handheld camcorder, enjoy shooting simple video and capturing stills using the camera's recording capabilities. The camera automatically switches to Action Mode upon attachment of the Battery Pack (DC1A).

### Parking Mode

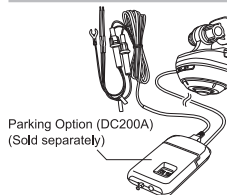

Parking Option (DC200A)  
(Sold separately)

\*Parking Option (DC200A) is required. (Sold separately)

In Security Mode, d'Action 360 keeps your parked car under surveillance. From keyings to hit-and-runs, d'Action 360 can record all the accidental or intentional moments that take place around your car. When the car engine is turned off with the Parking Option (DC200A) connected, the camera automatically switches to this mode.

⚠ This Parking Option (DC200A) is only for use with DC12V negative-grounded vehicles.

# Table of Contents

<b>Introduction</b> .....	1	<b>Useful features</b> .....	28
<b>Features of d'Action 360</b> .....	2	*Checking the remaining storage space in the "Manual Recordings" folder	
<b>Using this Product safely</b> .....	5	*Checking the remaining battery	
<b>Product contents</b> .....	11	*Pausing camera operation	
<b>Optional add-ons</b> .....	13	*Parking Mode alert function	
<b>Preparation</b> .....	14	<b>Changing the camera settings</b> .....	29
*Inserting the memory card		*Changing the recording resolution	
*Connecting to a smartphone		*Changing the impact detection sensitivity	
*Checking the mounting position		*Changing the SSID and password	
*Checking the view range		*Changing the partition type	
<b>Installation</b> .....	19	*Resetting the device	
<b>Capturing images/videos</b> .....	22	*Changing other settings	
*Capturing images/videos in Driving Mode		<b>Others</b> .....	33
*Capturing images/videos in Action Mode		*Formatting the memory card	
*Capturing images/videos in Parking Mode		*Upgrading the camera body	
<b>Viewing/deleting media</b> .....	25	*LED indicators	
*Viewing/deleting media on a smartphone		*What to do after an accident	
*Viewing/deleting media on a PC		<b>Troubleshooting</b> .....	38
		<b>Specifications</b> .....	40
		<b>Warranty</b> .....	42





<b>What kind of video can I record?</b>	➔ p.18
p.29 ← <b>I want to capture high-quality images and video.</b>	
<b>My camera responds too quickly to impacts...</b>	➔ p.29
p.30 ← <b>How many hours of footage can I record?</b>	
<b>I want to check my recordings on my smartphone!</b>	➔ p.25
p.14 ← <b>What type of memory card can I use?</b>	
<b>How do I update my d'Action 360 camera?</b>	➔ p.33

# Using this Product safely







In order to use this Product safely and prevent any damage caused to you and surrounding people/property, please ensure to read this manual carefully before use.

## Cautionary symbols

Graphic symbols are used in this manual to indicate cautionary matters, based on both the level of seriousness and the subject matter. Please ensure a thorough understanding of what each symbol represents before reading.

-  If the Product is handled improperly, possibility of death or serious injury may occur.
-  If the Product is handled improperly, possibility of injury or property damage may occur.
-  Improper handling of the Product may be regarded as violation of the law.
-  Useful tips to know when handling the Product.

## For your safety, please follow the below instructions:

-  Do not use this Product if it is broken, not working, or shows any other signs suggesting an abnormality. To prevent possible accidents or fire from occurring, stop using the Product immediately if you notice any smoke, abnormal noises, or abnormal smells, etc.
-  Check that the Product is securely installed before driving your car. A Product that has detached or fallen down may result in injury or accidents occurring.
-  Do not suddenly accelerate or make any sharp turns for the sole purpose of checking the performance of the Product. Operating your vehicle in such a way may lead to injury or accidents.
-  Do not use the Product where it is prohibited, such as in hospitals or on an aircraft. The Product may cause pacemakers and other electronic medical devices to malfunction.
-  Keep the power cable and terminal portions clean, wiping away any dust or dirt that may have gathered. Dust and dirt can prevent secure electrical contact, which may lead to electric shock or fire.
-  If you are not planning on using the Product for a long period of time, unplug the power cable from the camera body. Electric discharge from the vehicle battery or fire may occur. Additionally, fire or product failure may occur if the Product has been left in a closed space, in the hot sun, or in high temperatures for an extended period of time.
-  This Product is not dustproof, rainproof, or waterproof. To prevent electric shock, fire or product failure, keep it away from water and other foreign matter. Do not handle with wet hands.

 This Product operates using the same frequency band (2.4GHz band) as the following instruments or radio stations:

- (1) Industrial, scientific, or medical devices/appliances such as microwave ovens.
- (2) Private, licensed radio stations to identify and track electronic tags, used for example, on factory production lines.
- (3) Specific low-power radio stations (stations permitted to operate without a license)



Using this Product may cause radio-frequency interference (RFI) with the above-mentioned instruments and/or radio stations.

- 1) Before use, ensure there are none of the above-mentioned instruments or radio stations in operation around the Product.
- 2) Stop using the Product immediately if it has ever caused any radio-frequency interference to any private, licensed radio station as described above in (2).

 Do not use the Product if condensation (water droplets) has formed on the inside. Condensation is more likely to form when the Product is moved from a low temperature environment to a high temperature environment, and may cause the Product to malfunction or heat up.

 Do not drop or apply excessive force on the Product.

## Installing the Product

-  Do not mount the Product or distribute its cables around areas where operation of the vehicle's airbags may be obstructed. In the event of car crash, the airbag may not work properly or lead to an accident/injury upon inflating.
-  Install the Product properly according to this manual. Keep the camera body attached to the mount while driving and during inspection. Car products mounted incorrectly may not only be regarded as a violation of your local traffic laws, but may also lead to road accidents.

 To prevent product failure or the loss of data, do not place the Product near magnetic objects.

 To prevent electric shock or product failure, do not insert metallic objects such as pins or wires into the apertures of the Product.

 Do not operate the Product while you are driving. Doing so may lead to accidents. Certain laws prohibit the handling of any such devices while operating a vehicle.

 To prevent electric shock, fire, or product failure, do not disassemble, attempt to repair, or alter this Product in any way.

 Do not remove the compliance certificate label pasted on the Product. Use of an unlabeled Product is prohibited by law.

 Please follow the local and state laws.

 Radio-frequency interference may occur with other electrical devices such as the radio or vehicle GPS systems. If such interference has occurred, change the installation location.



## Powering the Product

⚠ Use the USB power socket alone. Overloading or splitting the connection may lead to excessive heat or fire.

⚠ Hold the connector portion of the power cable when unplugging. A damaged power cable may cause electric shock or fire.

⚠ This product is only to be used with DC 12V/24V negative-earth vehicles. Using this product with other vehicles may result in product malfunction. Please note, the Parking Option (DC200A) is only for use with DC 12V negative-ground vehicles.

👉 This Product automatically switches between three operational modes by recognizing its electric power supply source. Ensure you use only the add-on accessory products included in this Product or those sold separately. Some third-party USB cables and USB power sockets may not be compatible with this Product.

👉 The total outlet amperage of the attached USB power socket is a maximum 3.0A (amps). If the USB power socket is used in combination with other products and the total outlet amperage exceeds 3.0A, no electric power will be supplied to the camera body. The maximum electrical power consumption of this Product is approximately 800mA (at DC12V).

👉 Some cars (such as those imported from overseas) are designed to keep supplying electrical power to their cigarette lighter receptacle, even with the engine turned off. If your car falls into this category, unplug the Product when the engine is turned off.

👉 After the camera body is switched on, it may take up to approximately 30 seconds to begin recording.

👉 In some cars with a start-stop system, the supplied voltage may be reduced in order to restore the electric power for restarting the engine. Due to this, the power supply to this Product may be stopped.

## The camera body

⚠ To prevent possible deformation or fire from occurring, do not leave the camera body in areas where temperatures can rise quickly, such as on the dashboard.

⚠ If the camera body has become hot after using it for long periods of time. Do not allow it to come into direct contact with your skin to avoid potential burns.

⚠ To prevent product failure, do not touch the terminals on the camera body.

⚠ When cleaning the camera body, do not use solutions containing abrasive compounds, alcohols, or organic solvents.

⚠ To prevent product failure, avoid exposing the camera lens to direct sunlight for long periods of time.

👉 If the surface of the lens has attracted dirt, sand, fingerprints, etc., wipe clean using a dry, clean and lint-free cloth.

👉 Due to the characteristics of the electrical components of this Product, the surface/internal temperatures of the camera may increase depending on the conditions of use. When the ambient temperature exceeds the operating temperature range, Product operation will be stopped for protection. If Product operation is stopped, resume operation once the camera temperature has decreased.

## The GPS system

👉 The actual position of your car is determined by microwave signals broadcast from GPS satellites. Without receiving such signals, the precise position of your car cannot be determined.

👉 Depending on the ambient environment or geographic factors, the Product may not be able to adequately receive GPS signals or receive GPS signals at all.

👉 GPS satellites are controlled by the U.S. Department of Defense and their accuracy is subject to change without prior notice.

👉 Do not use this Product near other GPS products. Doing so may cause such products and this Product to malfunction.

👉 Using this Product near a TV antenna may cause a deterioration in the reception sensitivity, flickering and/or noise from the TV set.

👉 In order to receive clear GPS signals, do not place obstructive items around the Product.

👉 When the Product is switched on, it may take time until it starts receiving GPS signals. Allow between 30 seconds to a few minutes, depending on the signal reception environment, weather, vehicle conditions, and position of the Product.

👉 GPS signal reception may be hindered if the front windshield of your car has been surface-treated with a coating, etc.

## Recording images, video and data

⊘ Do not use the recorded images, videos and/or data for illegal purposes.

⊘ In some cases, your recorded images, video and/or data may constitute an infringement on the legal rights of a third party. Car Mate takes no responsibility for any matters with regard to, and arising from, the content of the images, videos and/or data recorded on this Product.

👉 This Product is not guaranteed to produce validity as evidence for any accidents or to identify the license plate, model, or color of any vehicle.

👉 This Product is not guaranteed to record in any and all circumstances. Car Mate takes no responsibility for any loss arising from the use or failure of this Product or from any damage to any recorded video and/or data.

👉 Blinking or discoloration may make it difficult to distinguish between recorded LED traffic lights.

👉 Recording performance and time may vary depending on the object being recorded or on the ambient environment.

👉 Recording quality may deteriorate depending on the installation location or the shooting subject, such as extreme loss of light or alternating light and dark.

👉 Keep the camera lens surface and all car windows clean. Irregular light reflection and refraction caused by dust and other foreign matter may affect recording quality.

👉 To record in highest possible quality in darkness, ensure you turn on the headlights or fog lights of your car.

## The memory card

- ⚠ If the memory card has become hot after using it for long periods of time. Do not allow it to come into direct contact with your skin to avoid potential burns.
- ⚠ To prevent product failure, do not touch the memory card with oily or wet hands.
- ⚠ To prevent the possible corruption of data or damaging the memory card, do not remove the memory card during data backup, formatting, while resetting your PC system, or during operation.
- ⚠ To prevent possible memory card failure and loss of data, do not drop or apply excessive force to the memory card.
- ⚠ To prevent possible breakage, failure, and malfunction of the memory card, do not insert any foreign objects into the slots or do not touch the terminal portion of the Product.
- ⚠ Insert the memory card in the correct orientation until it clicks in place.  
To avoid damaging the memory card, do not insert it forcibly.
- ⚠ To prevent possible product failure, do not switch off the camera, unplug the power cable, or detach the add-on battery pack (sold separately) while updating the camera body.

- 👉 Initialize (format) your memory card when:  
\*Using a brand-new card for the first time.  
\*Using a memory card that has been formatted on another camera or computer.  
\*It appears that reading and writing speeds have slowed down.  
\*You wish to delete all the data on the memory card.

- 👉 Memory cards are expendable supplies. After using it a certain number of times, normal recording may be impeded due to breakage in part of its memory sector.

- 👉 Ensure to back up important data on other devices. Data stored on a memory card may be overwritten or deleted.

- 👉 Before purchasing a brand-new memory card for this Product, check the specifications on page 14. Using an incompatible memory card may lead to loss of data or failed recording.

- 👉 Store your memory cards in a dry, cool place.

## Parking Mode

- ⚠ When using this Product in Parking Mode, always use the Parking Option (DC200A). Never use other third-party cables to directly connect the Product to the power source, as doing so may lead to problems such as a drained car battery.

- 👉 Car Mate takes no responsibility for any damage or loss arising from the drainage of your car battery while using the Product in Parking Mode.

## Copyright

- ⊘ According to copyright law, you cannot use recorded images, videos and/or data without permission of their right holder for any purposes other than your own personal use. If you plan to use this Product at live demonstrations, shows, or exhibitions, follow the rules of the organizers.

## Stickers

- ⊘ Sticker positioning on vehicles must comply with road safety standards. Please follow the local and state laws. To ensure a strong adhesion, please take care when sticking onto a painted surface.

# Product contents

Before use, check the Product for the following contents.

- Camera body x 1

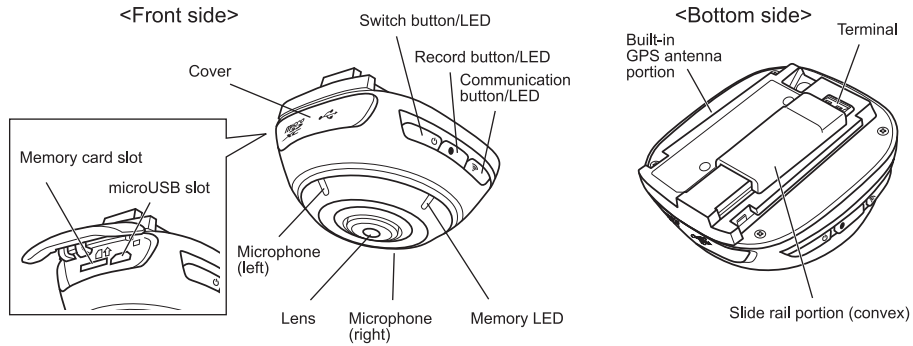

- Mount x 1

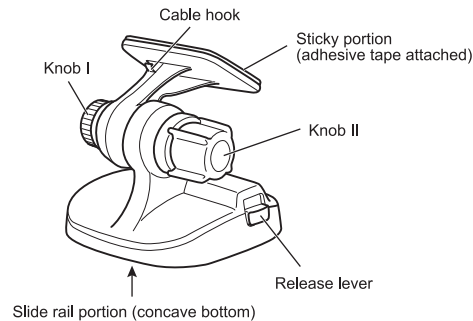

- Power cable x 1

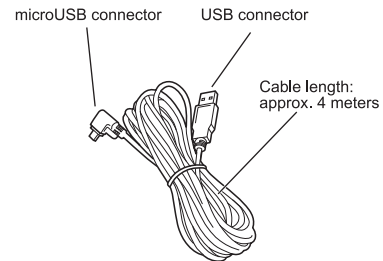

- USB power socket x 1  
2 × 1.5 A port

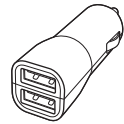

- Communication cable x 1

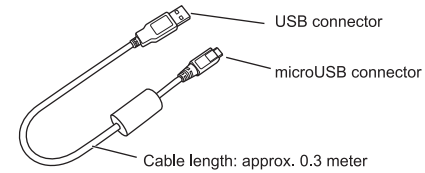

- Sticker x 1



- Cable clip x 3

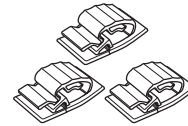

- Memory card x 1  
microSDHC 16GB  
(UHS-I, Speed class 3)



- Instruction manual (this book)

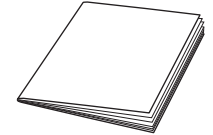

- d'Action app for smartphone (iOS/Android)

d'Action 360 (iOS)



d'Action 360 (Android)



- d'Action software for PC (Windows)



[https://daction.carmate.jp/support/app\\_pc.html](https://daction.carmate.jp/support/app_pc.html)

Check website for smartphone and PC devices compatibility issues in playback.  
[https://daction.carmate.jp/support/pdf/matching\\_en.pdf](https://daction.carmate.jp/support/pdf/matching_en.pdf)



## Optional add-ons

Please purchase the following optional add-ons according to your needs.  
(Available as of August 2018)

### ● Battery Option (DC100A)

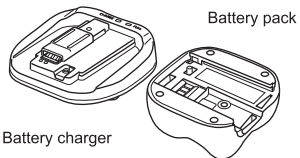

This is a portable battery unit with built-in lithium-ion batteries. By attaching this unit to the camera body, you can use the camera outside of your car.

### ● Parking Option (DC200A)



This is a cable set that allows the camera to receive electric power from the battery in your car while it is parked, and keep it under surveillance.

⚠ This Parking Option (DC200A) is only for use with DC12V negative-grounded vehicles.

## Preparation

### Inserting the memory card

#### 1 Ensure the power is switched off.

Ensure the power of the camera body is switched off, and that all the LEDs are off.

#### 2 Inserting the memory card

Open the cover on the camera body. Firmly insert the memory card in the correct orientation until it clicks into place.

##### Removing the memory card

When removing the memory card, push it in until you hear a click and release to allow a portion of the memory card to emerge from the camera body. Slowly pull the pushed-out portion to remove the memory card.

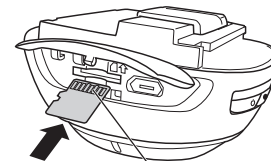

Terminal portion

##### ⚠ CAUTION

\*To prevent possible malfunction, do not store data that has been saved on a device other than this Product.

\*Always check the orientation of the memory card; inserting it in the wrong orientation may lead to breakage or malfunction.

\*Before removing the memory card, ensure the power is switched off. Removing it while the power is on may cause breakage of the card and/or corruption of data.

##### MEMO

Before using a third-party memory card, please check the compatibility below.

Card type	microSDHC or microSDXC
Speed class	UHS-I - Speed class 3
Capacity	16GB - 128GB

(As of August 2018)

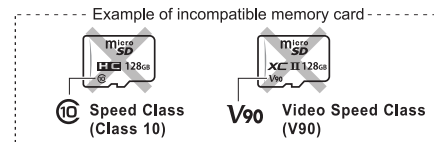
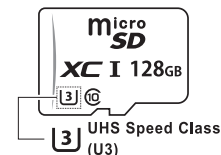

##### ⚠ CAUTION

\*Using incompatible memory cards may cause loss of data and/or recording failure.

\*Some third-party memory cards may be recognized more slowly, or be difficult to insert/remove.

\*Depending on the memory card capacity, start-up of the Product may take longer.

For simultaneous processing of both continuous and impact recording, or for 4K-equivalent recording, a minimum guaranteed speed of 30 MB/sec or more is required.

## Connecting to a smartphone

### 1 Install the d'Action app on your smartphone

To play videos recorded by this Product on your smartphone, you must first download the d'Action app. Download it on App Store or Google Play.

d'Action 360 (iOS)



d'Action 360 (Android)



### 2 Attaching the camera body to the mount

Match the convex portion of the camera body with the concave portion of the slide rail portion on the mount. Slide them into each other until they click.

#### Detaching the camera body

While lifting the release lever on the mount, slide the camera body out.

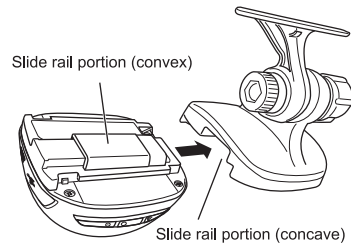

### 3 Connecting the power cable

Insert the microUSB connector on the power cable into the camera body, and the other USB connector into the USB power socket. Insert the USB power socket into your car's cigarette lighter receptacle.

\*Ensure each connector is correctly oriented.

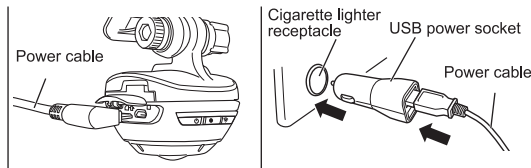

### 4 Turning on the engine

Turn on your car engine (turn on the ignition) and ensure all LEDs light up after a few seconds.



\*The memory LED will also light up.

### 5 Turning on Wireless LAN (Wi-Fi) on your smartphone

Turn on "Wi-Fi" under settings on your smartphone.

<Display example>



### 6 Selecting the SSID and entering the password

By turning on "Wi-Fi" as in procedure 5, a list of connectable wireless devices will be displayed. Select the SSID that starts with "dAction360", and enter the password.

```
<Initial values>
SSID: dAction360_xxxxxxx
Password: 12345678
```

\*Create your own SSID and password later. (See page 29.)

<Display example>

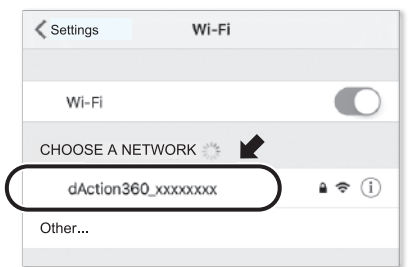

### 7 Opening the app/confirming connection

Open the d'Action 360 app and check that a connection has been established.

If you are unable to establish a connection, turn off your car engine (turn off the ignition) and start again from the procedure 4.

## Checking the mounting position

After checking the video using your smartphone, determine where the camera is mounted inside your car and how the power cable is arranged. Follow the instructions below.

\*Install the Product properly according to this manual. Car products mounted incorrectly may be regarded as a violation of your local traffic laws. Please follow the local and state laws.

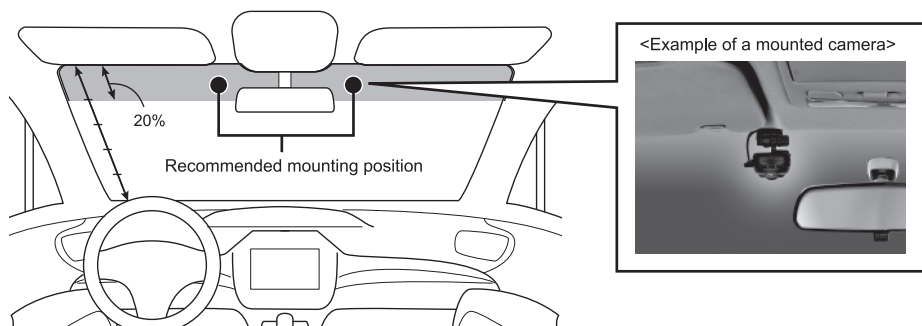

**CAUTION** When mounting the camera, ensure to meet all the below requirements.

- \*The mounted camera does not interfere with the driver's vision and operation of the vehicle.
- \*The mounted camera does not block the rearview mirror, or obstruct the vehicle's airbags.
- \*The camera is mounted within the upper 20% portion of the windshield. (See illustration above)
- \*The camera is mounted so that its lens is within the wiping range of the windshield wipers.
- \*The taped part of the camera does not overlap any heated wire printed on the windshield or antennae.
- \*If additional security or safety cameras are already in place, the camera to be mounted should not be within the view of such camera.
- \*No cable or metallic objects should be between the front windshield and the GPS antenna. (see illustration on the right)

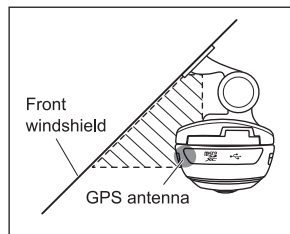

## Checking the field of vision

While checking the video on your smartphone app, confirm an approximate position for the camera and approximate angle of the lens.

\*Do not start mounting yet.

### MEMO

#### View angle of recorded video

This Product is a whole-sky, 360-degree camera. Its recording range is hemispherical, with viewing angles 360° horizontally, and 194° vertically. (Figure 1) If the camera is mounted with the lens facing directly below, you can simultaneously record video of inside and outside of your car. (Figure 2)

Figure 1

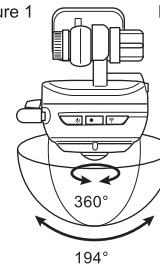

Figure 2



After determining an appropriate mounting position, remove the power cable from the camera body and detach the camera body from the mount.

# Installation

- 🔧 Install the Product outdoors where GPS signals can be easily received.
- 🔧 Some commercially-available USB cables and USB power sockets may not work properly. Please ensure you use the included accessories or optional add-ons for this product.

## 1 Cleaning the mounting area

Wipe the mounting surface clean with mild detergent. Wipe again with a water-soaked cloth. Then again using a dry cloth.

## 2 Attaching the mount

Peel the release paper off the mount. Orient the mount so the release lever faces to the right. Tape the mount firmly onto the front windshield.

\*To stabilize the tape adhesion, leave the mount for at least 24 hours without the camera attached. Do not peel off and re-tape the mount, as doing so will lower the adhesiveness of the tape.

\*Do not drive your car until the camera body is attached to the mount.

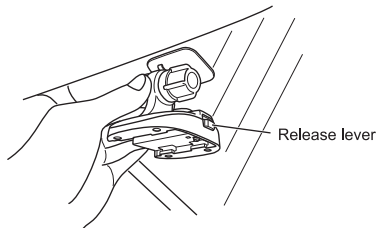

## 3 Attaching the camera body to the mount

Match the convex portion of the camera body with the concave portion of the slide rail portion of the mount. Slide them together until they click.

## 4 Arranging the power cable

Arrange the power cable neatly using the cable clips included in the Product.

- 🔧 For a neater arrangement, keep the power cable running through the cable hook located on the upper portion of the mount. Be sure to have some extra length of the power cable available in advance.

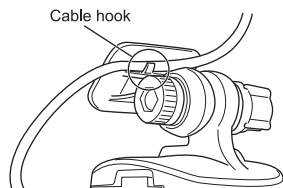

## 5 Checking the memory card is inserted and connecting the power cable

Open the cover to ensure the memory card is inserted. Insert the microUSB connector of the power cable into the USB power socket.

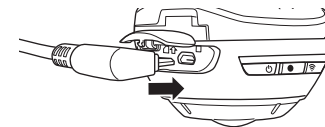

## 6 Inserting the power cable into the cigarette lighter receptacle

After inserting the microUSB connector of the power cable into the USB power socket, insert the USB power socket into your car's cigarette lighter receptacle.

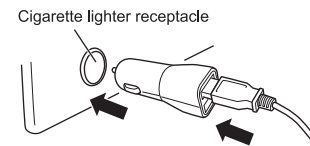

## 7 Turning on the engine

Turn on your car engine (turn on the ignition) and ensure all LEDs light up after a few seconds. In order to set the date and time, the camera must receive GPS signals. Keep the engine running for at least 40 seconds.



## 8 Connecting to a smartphone

After ensuring the communication LED  is on, connect the camera and your smartphone wirelessly. Open the d'Action app.



## 9 Adjusting the lens angle

While checking the app display on your connected smartphone, adjust the lens angle. Once you have determined your ideal lens angle, hold Knob I firmly by hand so as not to let it turn and turn Knob II to fix the lens in place.

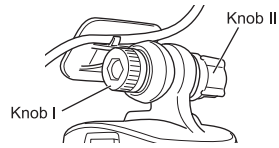

### MEMO

#### Lens angle and recorded footage

Adjust the lens angle depending on your preferred recording field of view. (See images below) When the lens faces the driving direction, the camera will record most of the road traffic ahead. Adjusting the lens angle to face inside the car will allow the camera to record the inside of the car, and the traffic behind it. Please set according to preference.

<Lens facing the driving direction>

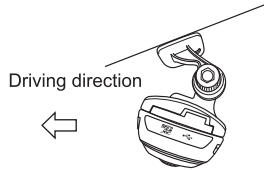

<Lens facing directly below>

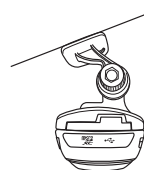

<Lens facing the inside of the car>

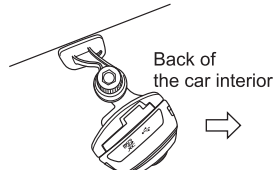

Impact detection sensitivity is maximized when the lens is facing directly below. The sensitivity decreases as the camera lens angle increases.

## 10 Turning off the engine

After fixing the lens angle, turn off your car engine (turn off the ignition). This completes the camera installation.

# Capturing images/videos

## Capturing images/videos in Driving mode

### 1 Turning on the engine to switch on the camera

By turning on your car engine (turning on the ignition), the camera is automatically switched on to begin continuous recording. Ensure all LEDs are on within a few seconds of starting the engine. \*It may take up to 30 seconds for the camera to begin recording after being switched on.

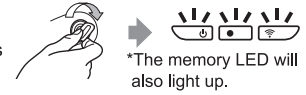

\*The memory LED will also light up.

### 2 Recording

In Driving Mode, the four types of recording modes can be used as follows.

On the memory card, one folder will be created for each recording mode. Captured/recorded files are recorded in their respective folder together with geotagging (geographical identification metadata).

<ul style="list-style-type: none"> <li>Recording continuous footage</li> </ul>	<ul style="list-style-type: none"> <li>Continuous recording</li> </ul> <p>The camera records video continuously from the moment the car engine is turned on until it is turned off. One file is saved every minute. When the folder becomes full, the most recently saved file overwrites the oldest file.</p> <p>*The camera will not record continuously in manual recording mode.</p>	<p>1 minute</p>
<ul style="list-style-type: none"> <li>Capturing any potential road incidents</li> </ul>	<ul style="list-style-type: none"> <li>Impact recording</li> </ul> <p>When the camera detects an impact, it stores the footage from 10 seconds before and 10 seconds after (20 seconds total). When the folder becomes full, the most recently saved file overwrites the oldest file.</p> <p>*The manual recording mode supersedes the impact recording; in the manual mode, the camera will not record any footage even if an impact is detected.</p>	<p>10 seconds</p>
<ul style="list-style-type: none"> <li>Capturing scenery</li> <li>Capturing the inside of your car</li> </ul>	<ul style="list-style-type: none"> <li>Manual recording (See p.32 for settings)</li> </ul> <p>Manual recording mode has two patterns available to choose from.</p> <ul style="list-style-type: none"> <li><b>Normal (default setting)</b></li> </ul> <p>This camera starts and stops recording either by pushing the record button on the camera body, or by switching it on using your smartphone. One file is saved every minute. When the folder becomes full, the camera stops recording automatically.</p> <ul style="list-style-type: none"> <li><b>Before &amp; after:</b></li> </ul> <p>By pressing the record button on the camera body or your smartphone, the camera will save footage from the previous 10 seconds, and the 30 seconds that follow (40 seconds in total). However, pressing the record button again before the 30 seconds has elapsed will end the recording. When the folder becomes full, the camera stops recording automatically.</p>	<p>1 minute</p>
<ul style="list-style-type: none"> <li>Capturing still images</li> </ul>	<ul style="list-style-type: none"> <li>Still image capture</li> </ul> <p>The camera takes one still image by switching it on using your smartphone. While the folder is full, you cannot take any more still images.</p> <p>*You cannot take any still images by pushing the button on the camera body.</p> <p>*You cannot take any still images while the camera is in manual recording mode.</p> <p>*You cannot take any 4K equivalent still images while the camera is in driving mode.</p>	

### 3 Turning off the engine to switch off the camera

By turning off your car engine (turning off the ignition), the camera is automatically switched off. Ensure all LEDs have turned off within a few seconds of stopping the engine.



## Capturing images/videos in Action mode

\*Battery Option (DC100) is required. (Sold separately)

### 1 Attaching the Battery Pack

Attach the fully charged Battery Pack (sold separately) to the camera body.

### 2 Press and hold the switch button to switch on

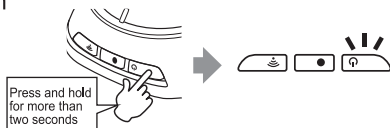

By pressing and holding the switch button  for more than two seconds, the camera is switched on. Be sure the switch button LED on the camera body is on.

\*You will be able to power on the camera body approximately two seconds after attaching the battery pack. Pressing and holding the switch button before this time has elapsed will have no effect.

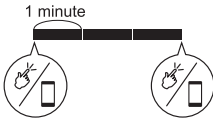

### 3 Recording

In Action mode, two types of recording modes can be used as follows. On the memory card, one folder will be created for each recording mode. Captured/recorded files are recorded in their respective folder together with geotagging (geographical identification metadata).

<p>●Capturing scenery</p>	<p>■Manual recording The camera starts and stops recording either by pushing the record button on the camera body or by switching it on using your smartphone. One file is saved every minute. When the folder becomes full, the camera stops recording automatically.</p> 
<p>●Capturing still images</p>	<p>■Still image capture The camera takes one still image by switching it on using your smartphone. While the folder is full, you cannot take any more still images. *You cannot take any still image while the camera is in manual recording mode. *You cannot take any still images by pushing the button on the camera body.</p> 

### 4 Press and hold the switch button to switch off

By pressing and holding the switch button  for more than two seconds, the camera will switch off. Ensure the switch button LED on the camera body is off.

#### ⚠CAUTION

Do not detach the battery pack during recording.  
Before detaching the battery pack, stop recording and switch the power off.

## Capturing images/videos in Parking Mode

\*Prking Option (DC200A) is required. (Sold separately)

### 1 Turning off the engine

Turning off your car engine (turning off the ignition) with the Parkig Option (sold separately) connected will automatically stop Driving Mode and momentarily switch off the camera. From here, the camera will automatically switch on and change to Parking Mode. Ensure the switch button LED is blinking green intermittently.

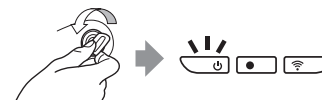

### 2 Recording

In Parking Mode, the following Parked recording mode can be used. Recorded files are stored in a folder on the memory card. \*GPS geotagging is not recorded.

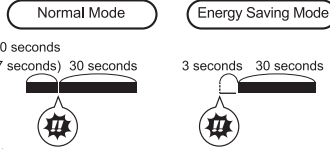
<p>●Recording hit-and-runs, etc.</p>	<p>■Parked recording *Normal mode: When the camera detects an impact, it records 10 seconds of footage (Full HD) or 7 seconds (4K) from before, and 30 seconds from after the impact (total 40 seconds in Full HD, or 37 seconds in 4K). *Energy saving mode: When the camera detects an impact, it records footage approximately 3 seconds after the impact for 30 seconds. When the folder becomes full, the most recently saved file overwrites the oldest file. *If you turn on the car engine while recording in security mode, that portion of data will not be saved.</p> 
--------------------------------------	--

#### About Energy Saving Mode

This Product is equipped with an Energy Saving Mode, allowing for longer operation of the Product without putting strain on your car's battery. The camera will switch automatically to this Energy Saving mode when either the set switch time has elapsed since entering Parking Mode or the camera body has reached a high temperature. (See p.32 for switch time settings) When the camera switches to Energy Saving Mode, the switch button LED will turn off. In addition, if the ambient temperature exceeds the operating temperature range, camera operation will be stopped for protection.

### 3 Turning on the engine

Turning on your car engine (turning on the ignition) with the Parking Option connected will automatically stop Parking Mode and momentarily switch off the camera. From here, the camera will automatically switch on and change to Driving Mode. Ensure all LEDs have turned on within a few seconds of starting the engine.

# Viewing/deleting media

## Viewing/deleting media on your smartphone

\*If you are connecting to your smartphone for the first time, refer to the procedures on pages 15 and 16.

\*You cannot connect to your smartphone in Parking Mode.

### 1 Turning on Wireless LAN on the camera body

When the camera is connected to the car cigarette lighter receptacle or to the Parking Option (DC200A: sold separately)

Turn on your car engine (turn on the ignition) to automatically turn on Wireless LAN.

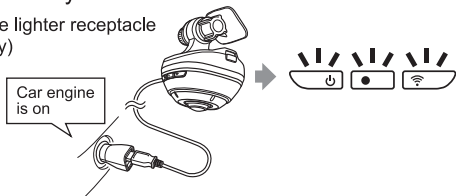

When the battery pack is attached to the camera

Press and hold the switch button  for more than two seconds with the battery pack attached.

After that, press the communication button .

\*You will be able to power on the camera body approximately two seconds after attaching the battery pack. Pressing and holding the switch button before this time has elapsed will have no effect.

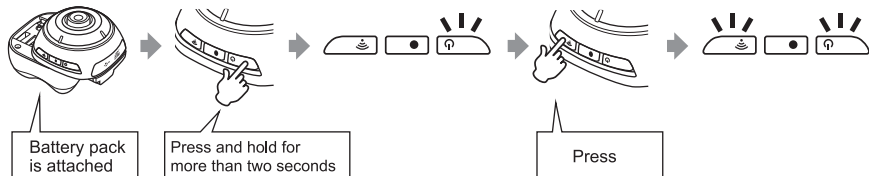

### 2 Turning on Wireless LAN on your smartphone

On your smartphone, turn on "Wi-Fi" under "Settings."



### 3 Selecting the SSID

\*A password is required only when connecting for the first time. (See page 16)

\*A password may be required if you have changed the SSID or password, or when the OS of your smartphone has been updated.

### 4 Opening the app/confirming connection

Open the d'Action 360 app and check that a connection has been established.

If no connection has been established, switch off the camera. Repeat the steps from procedure 1 on page 25.

### 5 Viewing/deleting media

Open the d'Action 360 app, and check that a connection has been established.

Play and delete your images/videos by following the app display.

#### MEMO

#### Data download time

Approximate times to transfer images and videos to your smartphone are as follows:

One-minute video (4K equivalent)	640 seconds
One-minute video (Full HD equivalent)	180 seconds
One image (4K equivalent)	2.5 seconds
One image (Full HD equivalent)	0.9 seconds

\*The above downloading times are provided for guidance only, and may differ greatly depending on the ambient environment and data content.

\*As the camera body directly communicates with your smartphone via wireless LAN, no communication fees are incurred.

## Viewing/deleting media on a PC

### 1 Installing the d'Action software on your computer

Visit our website below to download and install the d'Action software onto your computer.

[https://daction.carmate.jp/support/app\\_pc.html](https://daction.carmate.jp/support/app_pc.html)



### 2 Connecting the memory card to your computer

Connect the memory card to your computer by following either of the steps below.

\*Detach the camera body from the mount. Connect the camera body directly to your computer by using the communication cable (included in the Product).

\*Remove the memory card from the camera body. Connect the memory card to your computer by using a third-party card reader.

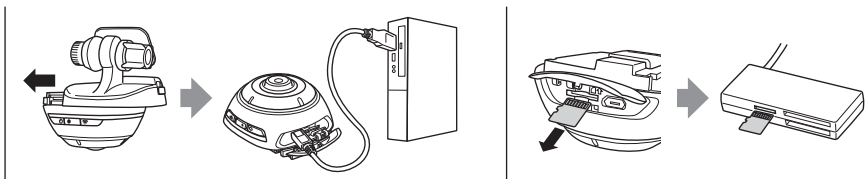

### 3 Starting the d'Action software to load the files

Start the d'Action software and load the files from the memory card.

#### ⚠ CAUTION

\*Do not remove the memory card while data is being read.

### 4 Viewing/deleting media

View your images/videos by following the software display screen.

When deleting files, either delete them directly from the memory card, or format the memory card using the smartphone app. (See page 33)

\*Formatting a memory card will delete all of the stored files, and optimize its folder structure.

## Useful features

### Checking remaining storage space in the “Manual Recordings” folder

The memory LED on the camera body indicates the remaining recordable memory in the “Manual Recordings” folder.

\*The folders “Continuous Recordings”, “Impact Recordings”, and “Parked Recordings” can be overwritten. As such, the remaining memory is not indicated.

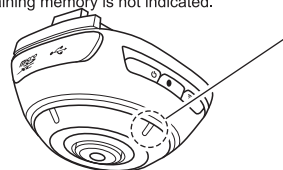

Memory LED

Green light is on	50% to 100% storage space remaining
Orange light is on	20% to 49% storage space remaining
Red light is on	Below 19% storage space remaining, or no memory card inserted
Orange light blinking	Memory card error

### Checking the remaining battery

\*Only when the Battery Kit Add-On (DC100) is attached

The switch button LED indicates the remaining battery of the attached battery pack.

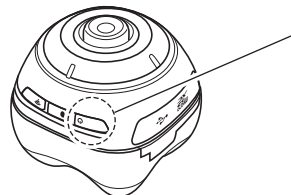

Switch button LED

Green light is on	50% to 100% battery remaining
Orange light is on	20% to 49% battery remaining
Red light is on	6% to 19% battery remaining
Orange light blinking	Below 5% battery remaining

### Pausing camera operation

In order to prevent the Parked recording from starting to record upon detecting any normal impacts that occur when the driver or passengers gets out of the car, the camera can be deactivated so as not to detect any impacts between one minute or ten minutes after the car engine is turned off. Deactivation can be set up using the smartphone app.

### Parking Mode alert function

If a recording has been made while in Parking Mode, the user will receive a voice notification when next starting the engine.

\*No sound will be produced if the camera is set to “Silent.” Further, this notification sound will be produced at the same volume regardless of whether the camera volume is set to “Loud” or “Quiet.”

# Changing the camera settings

**CAUTION** \*All recording modes will be stopped while you are changing the camera settings on the smartphone app.

## Changing the recording resolution

In some recording modes, the recording resolution can be changed to 4K equivalent.

Changing settings using the smartphone app.

You can change the recording mode settings as follows:

	Recording modes	4K equivalent (2880×2880)	★ Default setting ★ Full HD equivalent (1440×1440)
Driving Mode	Manual recording (Normal)	○*	○
	Manual recording (Before & after)	×	○
	Impact recording	×	○
	Still image capture	×	○
	Continuous recording	×	○
Action Mode	Manual recording	○	○
	Still image capture	○	○
Parking Mode	Parked recording	○	○

Diagram of recorded portions

(Unit: Pixels)

\*When manually recording 4K equivalent video in Driving Mode, a time lag of a few seconds occurs between pressing the recording button and the recording starting.

## Changing the impact detection sensitivity

You can change the impact detection sensitivity levels for Impact recording in Driving Mode, and for Parking Parked recording in Parking Mode. Change settings using the smartphone app.

The detection sensitivity is maximized when the lens faces directly below. The detection sensitivity decreases as the lens angle gets wider.

Detection sensitivity (Impact recording)	Highest sensitivity: Impacts are easily detected in Driving Mode ★ High sensitivity Medium sensitivity Low sensitivity Lowest sensitivity: Impacts are not easily detected in Driving Mode	↑ ↓
Detection sensitivity (Parked recording)	High sensitivity: Impacts are easily detected in Security Mode ★ Medium sensitivity Low sensitivity: Impacts are not easily detected in Security Mode *Check the detection sensitivity by knocking on the body of the vehicle.	↑ ↓

★ Default setting

## Changing the SSID and password

You can change the SSID and password. Change settings using the smartphone app.

\*If you forget your password, please reset the camera (see p. 31). The SSID and password will be reset to their initial settings.

## Changing the partition type

You can change the partition (the allocated capacity of each folder) according to how you use this product. After inserting the memory card in the camera body and turning on the power, please change the setting using the dedicated smartphone application.

**CAUTION** \*When you change the partition setting, the memory card will be formatted automatically and all files will be deleted.

**Standard** (Default setting: Recommended for those who often use the manual recording feature.)

Recording modes	Number of recorded pixels	16GB	32GB	64GB	128GB
Continuous recording	Full HD equivalent	22 mins	49 mins	102 mins	208 mins
Impact recording + Parked recording	Impact recording : Full HD equivalent	8 mins	19 mins	39 mins	80 mins
	Parked recording : Full HD equivalent				
	Impact recording : Full HD equivalent	2 mins	5 mins	10 mins	21 mins
	Parked recording : 4K equivalent				
Manual recording	Full HD equivalent	55 mins	119 mins	247 mins	504 mins
	4K equivalent	14 mins	31 mins	65 mins	132 mins
Still Image capture	Full HD equivalent	264 images	569 images	1180 images	2400 images
	4K equivalent	63 images	136 images	281 images	572 images

Full HD equivalent: 1440×1440 / 4K equivalent: 2880×2880

**Constant recording priority** (recommended for those who use the camera as a dashboard camera.)

Recording modes	Number of recorded pixels	16GB	32GB	64GB	128GB
Continuous recording	Full HD equivalent	<b>63 mins</b>	<b>135 mins</b>	<b>281 mins</b>	<b>572 mins</b>
Impact recording + Parked recording	Impact recording : Full HD equivalent	15 mins	32 mins	66 mins	136 mins
	Parked recording : Full HD equivalent				
	Impact recording : Full HD equivalent	3 mins	8 mins	17 mins	35 mins
	Parked recording : 4K equivalent				
Manual recording	Full HD equivalent	10 mins	21 mins	44 mins	91 mins
	4K equivalent	2 mins	5 mins	11 mins	24 mins
Still Image capture	Full HD equivalent	16 images	34 images	71 images	144 images
	4K equivalent	4 images	8 images	17 images	34 images

Full HD equivalent: 1440×1440 / 4K equivalent: 2880×2880

\*The above recording times and number of images are provided for guidance only, and are not absolutely guaranteed values. These will vary depending on the condition of use, subject, and ambient environment.

Continued on the next page

MEMO

\*Folder Structure

Files saved on the memory card are separated into the following folders for each recording function.

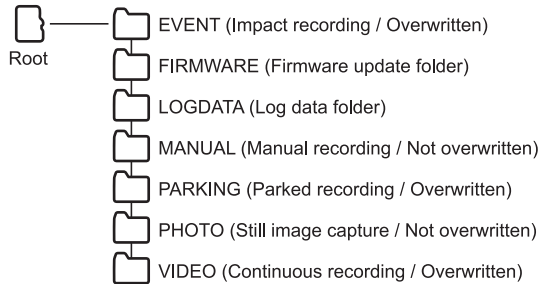

Resetting the device

All set values are reset. When the Product is in either of the following states, push the record button 5 times while holding down the communication button .

\*Driving mode/Power is ON (operating only during continuous recording)

\*Action mode/Power is ON (not recording)

\*This resetting process does not format or initialize the data on the memory card or the version of the camera body.

\*When the recording LED is lit red it cannot be reset.

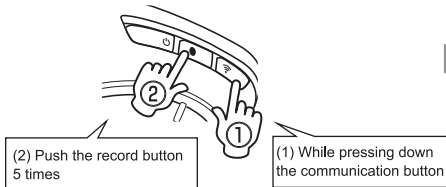

**CAUTION**

\*During this system reset, all LEDs will blink orange. Do not turn off the power, push any buttons, or insert/remove the memory card until the orange blinking turns off.

MEMO

This can also be carried out using the dedicated smartphone application.

Changing other settings

You can also change the settings below.

Change settings using the smartphone app.

WDR*	[ Driving Mode ]	★Strong	Weak	OFF
	[ Action Mode ]	Strong	★Weak	OFF
	[ Parking Mode ]	★Strong	Weak	OFF
Brightness (exposure)	-2 : Brightness (exposure) is adjusted to be darker -1 ★ 0 +1 +2 : Brightness (exposure) is adjusted to be lighter	↑ ↓		
Audio recording	★ ON : Record sound OFF : No sound recording			
Camera sound volume	Loud: Sound volume is maximized ★ Quiet: Sound volume is normal Mute: Sound volume is muted			
Deactivation time	★ One minute: No impacts are detected for one minute after the car engine is turned off. Ten minutes: No impacts are detected for ten minutes after the car engine is turned off.			
Manual recording patterns during Driving Mode	★ <b>Normal:</b> After beginning manual recording, the camera will continue recording until either recording is ended by the user, or the storage folder reaches maximum capacity. <b>Before &amp; after:</b> The camera records the 10 seconds of footage prior to manually starting the recording, and the proceeding 30 seconds (40 seconds total).			
Energy Saving Mode switch time	0 hours: The camera immediately switches to Energy Saving Mode upon entering Security mode ↑ ↓ ★ 16 hours: The camera switches to Energy Saving Mode once 16 hours have elapsed since entering Parking Mode			

★ Default setting

MEMO

\*WDR (wide dynamic range) technology adjusts the brightness of video recorded in light or dark places, reducing overexposure by headlights, etc.

## Formatting the memory card

Delete all files on the memory card to optimize its folder structure. Formatting can be done using the smartphone app.

**\*Formatting a memory card erases all of the files stored on it.**  
Back up any important data onto a storage device (such as a PC) prior to formatting.

**⚠ CAUTION** \*Be sure to format your memory card with this Product if; you are using the card for the first time, the card has been used with other devices, or the card has been formatted on a computer.  
\*We recommend you format your memory cards every six months.

## Upgrading the camera body

The firmware of the camera body is subject to updates due to specification changes or additional functions being added. Check the version of your camera. Please upgrade to the latest version using your smartphone or PC when it becomes available.

### MEMO

You can check your camera version using your smartphone app while it is wirelessly connected to the camera body. Check for the latest version on our website on the right.

[https://daction.carmate.jp/support/app\\_pc.html](https://daction.carmate.jp/support/app_pc.html)



## Upgrading using your smartphone

When a version upgrade for the camera body is available, by connecting your smartphone to the camera body and launching the dedicated smartphone application, the update will be applied. Follow the instructions on the dedicated application to complete the version upgrade.

## Upgrading using your PC

### 1 Downloading the latest firmware file onto your PC

Visit the website below and download the latest firmware files onto your computer's desktop.  
[https://daction.carmate.jp/support/app\\_pc.html](https://daction.carmate.jp/support/app_pc.html)

### 2 Extracting files

Extract the zip file you downloaded in procedure 1.

### 3 Connecting the memory card to your computer

Connect the memory card to your computer either by directly connecting the communication cable (included with the Product) to the camera body or by using a third-party card reader.

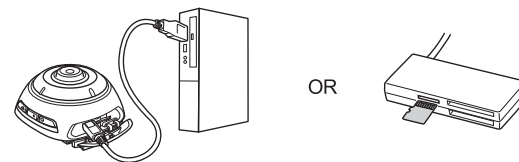

### 4 Copying the extracted firmware file onto the memory card

On your PC, open the "FIRMWARE" folder saved on the memory card. Copy and paste into this folder the "firmware.bin" file you extracted in procedure 2.

**⚠ CAUTION** \*Do not change the file name "firmware.bin".  
\*Do not remove the memory card during data transfer.

### 5 Reinserting the memory card into the camera body

When the file has finished copying, remove the communication cable. If the connection has been made via a card reader, remove the memory card from the reader and insert it back to the camera body.

Continued on the next page



## 6 Switching on the camera

Switch on the camera by doing either of the following:

\*Attach the camera body to the mount. Insert the microUSB connector of the power cable into the camera body, and turn on your car engine (turn on the ignition).

\*Attach the fully charged battery pack to the camera body. Press and hold the switch button for more than two seconds.

\*Software cannot be upgraded unless the battery level is 50% or more (the power LED is lit up green).

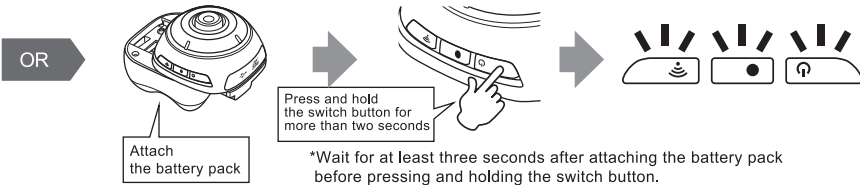
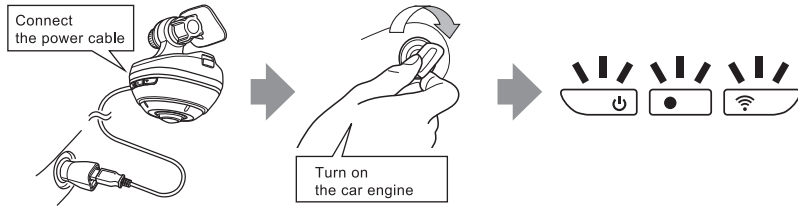

\*The camera body will begin updating automatically a few seconds after the camera body is switched on. During this update, all LEDs except the memory LED will start blinking in red.

**CAUTION** \*Do not turn off the power, press any buttons, or insert/remove the memory card until the red blinking turns off.

If updating has not started

\*The switch button LED is blinking orange (indicating an error)  
> Remaining battery level is insufficient for the update to take place. Fully charge the battery and repeat procedure 6.

\*All LEDs are off  
> Check the power connection and remaining battery level.

If updating has failed

\*Repeat all the procedures on page 34.

## LED indicators

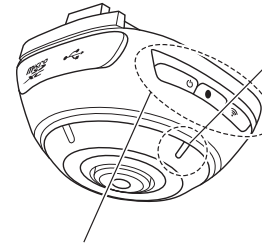

Memory LED	Indication	Page
Green on	50% to 100% memory remaining ("Manual Recordings" folder)	p.28
Orange on	20% to 49% memory remaining ("Manual Recordings" folder)	
Red on	Below 19% memory remaining ("Manual Recordings" folder), or no memory card inserted	
Orange blinking	Memory card error	

Switch button LED	Recording button LED	Communication button LED	Indication	Page
Green on	-	-	Power is ON	p.22-24
Green blinking	-	-	Power is ON (Parking/Normal Mode)	
Orange on	-	-	Power is ON (20% to 49% battery remaining)*	p.28
Red on	-	-	Power is ON (6% to 19% battery remaining)*	
No light is on	-	-	Power is OFF, or ON (during Parking/Energy Saving Mode)	p.22-24
Orange blinking	-	-	Power is ON (below 5% battery remaining) / Error	p.36

-	Green on	-	Continuous recording in progress	p.22-24
-	Red on	-	Impact/Manual/Parked recordings in progress	
-	Red blinks once	-	Still image capture	
-	No light is on	-	Recording has stopped	
-	Orange blinking	-	Error	

-	-	Green on	Wireless LAN is ON	p.25-26
-	-	Green blinking	Communicating with smartphone	
-	-	No light is on	Wireless LAN is OFF	

Orange blinking	Orange blinking	Orange blinking	Camera body is resetting	p.31
Red blinking	Red blinking	Red blinking	Camera body is being updated	p.33-35

\*Action mode only

# What to do after an accident

We recommend that you carry out one of the following procedures so that the video data recorded at the time of the accident is not overwritten.

**⚠ CAUTION** Move to a safe place, and turn off the engine before you go.

- Remove the power cable from the camera body  
Turn off the camera's power so that data from the time of the accident is not overwritten.

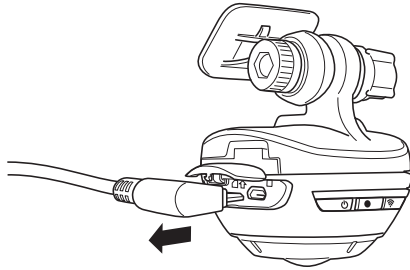

- Remove the memory card from the camera body  
Replace the memory card, or back up the video data recorded onto the memory card to another device.  
\*Please be careful with handling the removed memory card. (See p.9)

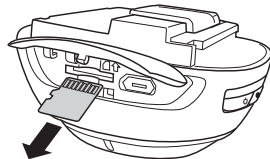

# Troubleshooting

Problem	Solution	Page
I cannot switch on the camera. (Driving mode/ Parking mode)	*Check the power cable and USB power socket are properly connected.	p.20
	*Check the camera body is not too hot. If the ambient temperature has exceeded the operating temperature range, cool it down and try switching it on again.	p.7
	*Temporarily remove the power supply cable from the camera body, then plug it back in again after about 5 minutes. Turn on the power supply. Keep the memory card inserted while doing this.	—
I cannot switch on the camera. (Action mode)	*Check the battery pack is securely attached to the camera body.	p.23
	*The switch button will not be active for approximately two seconds after the battery pack is attached.	
	*Press and hold the switch button for more than two seconds with the battery pack attached.	p.28
I cannot record video.  Recorded data has been deleted.	*Check the remaining battery. Charge if insufficient.	p.7
	*Make sure the camera body or battery pack is not hot or cold. Use the camera body and battery pack within their operating temperature range.	p.28
	*Check the remaining memory on the memory card. The "Manual Recordings" folder may be almost full.	p.22-24
Data seems incorrect somehow.	*For Impact recordings, Parking recordings, and Continuous recordings, the most recently saved file overwrites the oldest file when their respective folder becomes full. Ensure to back up any data you want to keep to an external storage device.	p.14
	*Check the memory card for its speed class and capacity.	p.14
Date/time are set incorrectly.	*This Product records the date and time based on world standard time. When accessing the memory card with a computer, while the times may differ, this is not considered product failure.  *The initial setting of the date and time may not have been completed. Keep the camera switched on for at least 40 seconds outdoors where GPS signals can be easily received.	—  p.20
Data transfer time to my smartphone is slow.	*As data is transferred wirelessly, transfer times can vary greatly depending on the environment. *Large files, especially videos recorded in 4K-equivalent, will take more time to transfer.	p.26
An error (orange light is blinking) occurs when pressing and holding the switch button.	*During Driving Mode and Parking Mode, the switch button cannot be operated.  *If this error occurs during Action Mode, the blinking orange light indicates the battery is low. Please charge the battery pack.	—  p.28
An error (orange light is blinking) occurs when pressing the record button.	*The folders for saving Manual recording data and Still Image capture data may be almost full. Check the remaining memory on the memory card using the smartphone app.  *The record button cannot be operated during Parking Mode or while connected to your PC.	p.28  —

Continued on the next page

Using this Product Safely  
Preparation  
Installation  
Capturing Images/Video  
Viewing/Deleting Media  
Changing Camera Settings  
Troubleshooting



Problem	Solution	Page
An error (orange light is blinking) occurs when pressing the communication button.	*During security mode or while connected to your PC, "Communication button is unavailable." (Wireless LAN cannot be turned on while in security mode.)	—
I cannot search or install the smartphone app.	*Your device may fall out of our operation guarantee. Please check the "List of Supported Devices / OS" on our website.	—
I cannot connect to my smartphone.	*During Parking Mode or while connected to your PC, connection to your smartphone is not possible. ----- *Close the smartphone app, and turn off wireless LAN. Open the app again and restart wireless LAN to see if a connection has been established. If the problem persists, turn off the smartphone app, and switch off the camera. Repeat the procedures on page 25.	— p.25-26
I am not notified of available updates on my smartphone.	*The latest firmware is automatically downloaded to your smartphone when launching the application with your smartphone connected to the Internet. For smartphones unable to connect to the Internet, such as smartphones without SIM cards, please update from a PC.	—
I cannot install the PC software.	*Your device may fall out of our operation guarantee. Please check the "List of Supported Devices / OS" on our website.	—
I cannot view images and video using the PC software.	*Your computer device may not be supported. Check the most up-to-date list of supported devices/OS on our website.	—
Images and videos are too light or too dark.	*Adjust WDR or brightness (exposure).	p.32
Geotagging cannot be obtained.	*During Parking Mode, geotagging cannot be obtained. *Geotagging is identified based on signals received from GPS satellites. Signal reception will be difficult in areas such as tunnels and areas shielded by densely-arranged buildings, or when items that emit radio waves or magnetic forces are placed around the camera body. *After the camera is switched on, it takes at least 40 seconds to obtain geotagging.	—
I cannot switch the camera to Driving mode.	*Check the camera is connected by the USB power socket and the power cable (both included in the Product). You cannot use third-party USB power sockets or microUSB cables. Contact our service center if you need additional sockets/cables.	p.7
I cannot switch the camera to Parking mode.	*Check the camera is connected by the power cable (included in the Product) and the cord of the Parking Option (DC200). You cannot use third-party microUSB cables or similar cords. Contact our service center if you need additional socket/cable. ----- *If your car power accessory power outlet is designed to not turn off for a while after the car engine is turned off, the camera will not immediately switch to Parking Mode. Parking Mode is started when the accessory power outlet is completely switched off.	p.7 —

## Specifications

Product name	d'Action 360
Product number	DC3000
Resolution	2880×2880 (4K equivalent/approximately 8 megapixels)
	1440×1440 (Full HD equivalent/approximately 2 megapixels)
Effective pixels	Approximately 1.3 megapixels
Image Sensor	CMOS 1/2.3
Frame rate	Maximum 27.5 fps *Automatically adjusted in high temperatures
Aperture	F2.0
Viewing Angle	Horizontal 360°/Vertical 194°
Power Supply	DC12V/24V (Camera body: DC5V) *When using the USB power socket
Power Consumption	DC12V : approximately 370mA (4K equivalent) approximately 240mA (Full HD equivalent)
	DC5V : approximately 800mA (4K equivalent) approximately 500mA (Full HD equivalent)
Satellites	GPS, GLONASS, Michibiki Quasi-Zenith Satellite System
Recording modes	Continuous recording, Impact recording, Manual recording, Still image capture
	Parked recording: Parking Option (DC200; sold separately) is required.
File formats	Video: MOV (Video: MPEG4-AVC/H.264, Audio: PCM stereo) Still image: JPEG
Supporting Memory	microSDHC / microSDXC (16GB to 128GB/UHS-I, Speed class 3 or higher)
Playback Support	d'Action app for smartphone (iOS/Android)
	d'Action software for PC (Windows)
Wireless LAN	Complies to IEEE802.11 b/g/n (2.4 GHz band)
Product dimensions and weight	H42mm×W62mm×D64mm (camera body)
	H104mm×W62mm×D64mm (with mount attached)
	Camera body: approximately 100 grams/Mount: approximately 47 grams
Others	Built-in triaxial G sensor
	Built-in stereo microphone
	WDR function installed
Operating temperature range	14°F to 104°F (-10°C to 40°C) (Parking mode)
	14°F to 104°F (-10°C to 40°C) (Parking mode)
Product Warranty	One year

\*\*"Android", "Google Play", and the "Google Play Logo" are trademarks or registered trademarks of Google Inc.

\*The "iOS" trademark is used under license from Cisco Systems, Inc. in the United States.

\*Windows® is a registered trademark or trademark of Microsoft Corporation in the United States and/or other countries.

\*microSD, microSDHC, and microSDXC are trademarks or registered trademarks of SD Card Association.

## FCC STATEMENT

Changes or modifications not expressly approved by the party responsible for compliance could void the user's authority to operate the equipment.

- The provided shielded USB cables must be used for connection to computer or peripherals in order to meet FCC emission limits and RF interference suppression.

Note: This equipment has been tested and found to comply with the limits for a Class B digital device, pursuant to part 15 of the FCC Rules.

These limits are designed to provide reasonable protection against harmful interference in a residential installation.

This equipment generates, uses and can radiate radio frequency energy and if not installed and used in accordance with the instructions, may cause harmful interference to radio communications.

However, there is no guarantee that interference will not occur in a particular installation.

If this equipment does cause harmful interference to radio or television reception, which can be determined by turning the equipment off and on, the user is encouraged to try to correct the interference by one or more of the following measures:

- Reorient or relocate the receiving antenna.
- Increase the separation between the equipment and receiver.
- Connect the equipment into an outlet on a circuit different from that to which the receiver is connected.
- Consult the dealer or an experienced radio/TV technician for help.

This transmitter must not be co-located or operated in conjunction with any other antenna or transmitter.

The available scientific evidence does not show that any health problems are associated with using low power wireless devices.

There is no proof, however, that these low power wireless devices are absolutely safe.

Low power Wireless devices emit low levels of radio frequency energy (RF) in the microwave range while being used. Whereas high levels of RF can produce health effects (by heating tissue), exposure of low-level RF that does not produce heating effects causes no known adverse health effects.

Many studies of low-level RF exposures have not found any biological effects.

Some studies have suggested that some biological effects might occur, but such findings have not been confirmed by additional research.

d'Action 360 (DC3000) has been tested and found to comply with FCC radiation exposure limits set forth for an uncontrolled environment and meets the FCC radio frequency (RF) Exposure Guidelines.

Product Name : d'Action360

Model Number : DC3000

This device complies with part 15 of the FCC Rules. Operation is subject to the following two conditions:

- (1) This device may not cause harmful interference, and
- (2) This device must accept any interference received, including interference that may cause undesired operation.

Responsible party : Car Mate USA, Inc.

Address : 383 Van Ness Ave Suite 1603, Torrance, CA 90501

Phone : 310-533-1647

## Warranty

### Warranty Provisions

1. In the case of product failure resulting from normal use, Car Mate will repair or exchange the product free of charge within the warranty period. (One (1) year from the date of purchase)
2. Repairs will incur a charge within the warranty period pursuant to the following:
  - (a) When this Warranty Document is not presented
  - (b) Product failure and damage due to incorrect use, improper repair and alterations
  - (c) Product failure and damage caused by transportation, movement, dropping, etc.
  - (d) When there is evidence of moisture, etc., having infiltrated the product from the outside
  - (e) Product failure and damage due to fire, earthquake, flood damage, abnormal voltage, pollution, use of power supply outside the specification (voltage / frequency), and other natural disasters and calamities
  - (f) When the prescribed items in this warranty certificate have not been filled, or the wording has been rewritten. However, the purchase date and dealer's name may be in the form of a receipt
  - (g) The external portion has been damaged
3. The loss of products, parts or accessories is not covered under warranty.
4. Products received from another person and resold items are not covered under warranty.
5. Please present this warranty document prior to requesting repairs at your place of purchase or at a Car Mate service center.
6. This Warranty Document will not be reissued, so keep it stored in a safe place.
7. This warranty is valid only for service in Americas.

### Car Mate USA, Inc.

383 Van Ness Avenue, Suite 1603

Torrance, CA 90501, USA

info@carmate-usa.com 310-533-4963 (FAX)

http://www.carmate-usa.com