



**HOSHIZAKI**

> B-301SA



> B-501SA



> B-801SA



- > **B-301SA**
- > **B-501SA**
- > **B-801SA**

Storage bins are essential to ensure continuous supply of ice and these bins are made to match Hoshizaki Ice Machines. Made from stainless steel, the bins are easy to clean.

## FEATURES

- > sturdy construction for side by side or stacked installations
- > non-corrosive bin liner for sanitary storage of ice
- > foamed in-place insulation in all bin walls for low melting rate
- > round edges for easy cleaning

## STORAGE CAPACITY

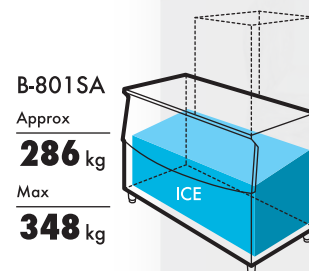
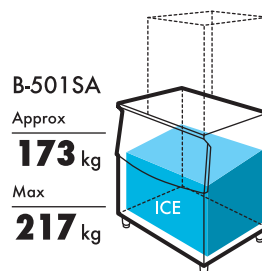
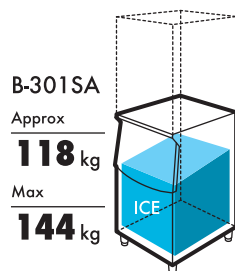

ICE STORAGE BIN SERIES

# DIMENSIONS & SPECIFICATION

## ● B-301SA

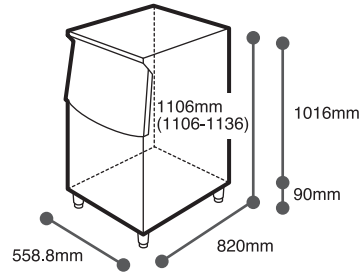

### BACK SIDE

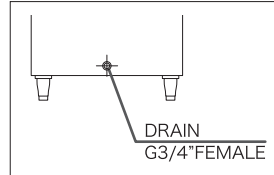

## ● B-501SA

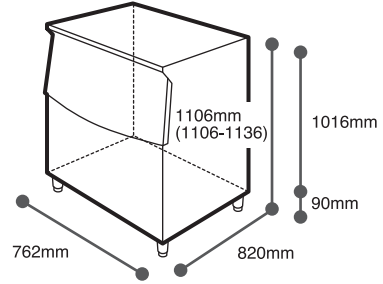

### BACK SIDE

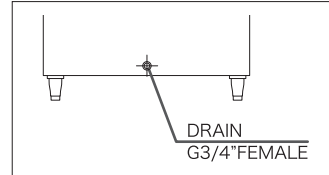

## ● B-801SA

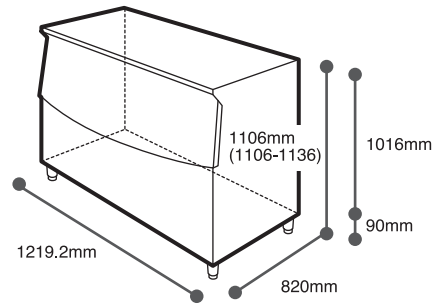

### BACK SIDE

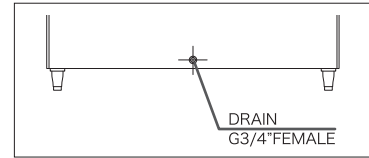

## SPECIFICATION

MODEL NAME	B-301SA	B-501SA	B-801SA
STORAGE CAPACITY	Approx : 118kg / Max : 144kg	Approx : 173kg / Max : 217kg	Approx : 286kg / Max : 348kg
OUTSIDE DIMENSIONS(W x D x H)	558.8 x 820 x 1106(1106-1136)(mm)	762 x 820 x 1106(1106-1136)(mm)	1219.2 x 820 x 1106(1106-1136)(mm)
DOOR STYLE	Upward Opening	Upward Opening	Upward Opening
INSULATION	Polyurethane Foam	Polyurethane Foam	Polyurethane Foam
ACCESSORIES	Scoop , Leg (4 pcs)	Scoop , Leg (4 pcs)	Scoop , Leg (4 pcs)
WEIGHT (NET / GROSS)	37kg / 49Kg	47kg / 62kg	64kg / 86kg

## COMBINATION

Ice machine	FM-300 FM-480 FM-600 IM-240A IM-220AA	KM-515 KM-650 KMD-201 KMD-270	KM-900	FM-251x2 FM-481x2 FM-600x2 IM-240Ax2	KMD201x2 KMD270x2 IM-220AAx2	KM-1301	IM-240D
B-301SA							
Top Kit	No Top Kit						
B-501SA							
Top Kit	8D		No Top Kit				
B-801SA							
Top Kit	8D+18D		18D	4DM	4DM+4DR	Not Top Kit	1MD