

ALTO-SHAAM®

**Hot Food Holding
Cabinet, Electric**



**Model:
500-PH/GD**

- **INSTALLATION**
- **OPERATION**
- **MAINTENANCE**

**HALO
HEAT®**

24•7
Your Service Hotline
1-800-558-8744

W164 N9221 Water Street • P.O. Box 450 • Menomonee Falls, Wisconsin 53052-0450 USA
PHONE: 262.251.3800 • 800.558.8744 USA/CANADA FAX: 262.251.7067 • 800.329.8744 U.S.A. ONLY
www.alto-shaam.com

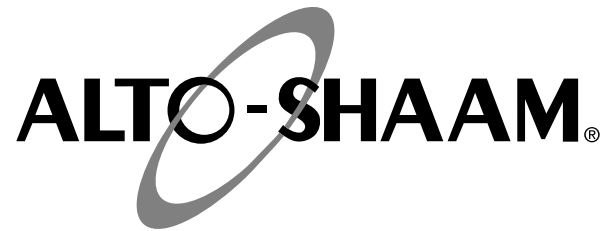

Delivery	1
Unpacking	1
Safety Procedures and Precautions	2

Installation

Installation Requirements	3
Leveling	3
Dimension Drawings	4
Options and Accessories	4
Electrical Specifications	5

Operating Instructions

User Safety Information	6
Before Initial Use	6
Heating Characteristics	6
Operating Instructions	6
General Holding Guidelines	7

Care and Cleaning

Cleaning and Preventative Maintenance	8
Protecting Stainless Steel Surfaces	8
Cleaning Agents	8
Cleaning Materials	8
Equipment Care	9
Clean Daily	9

Sanitation

Sanitation/Food Safety	10
Internal Food Product Temperatures	10

Service

Thermostat & Indicator Light Sequence	11
Thermostat Calibration	11
Exterior Service View & Parts	12-13

Wire Diagrams

Always refer to the wire diagram(s) included with the unit for most current version.

Warranty

Transportation Damage and Claims	Back Cover
Limited Warranty	Back Cover

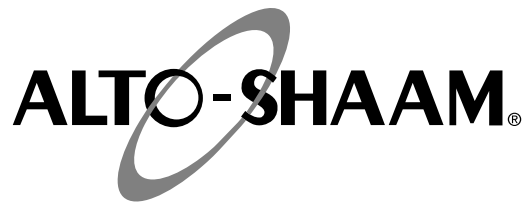

DELIVERY

This Alto-Shaam appliance has been thoroughly tested and inspected to ensure only the highest quality unit is provided. Upon receipt, check for any possible shipping damage and report it at once to the delivering carrier. *See Transportation Damage and Claims section located in this manual.*

This appliance, complete with unattached items and accessories, may have been delivered in one or more packages. Check to ensure that all standard items and options have been received with each model as ordered.

Save all the information and instructions packed with the appliance. Complete and return the warranty card to the factory as soon as possible to ensure prompt service in the event of a warranty parts and labor claim.

This manual must be read and understood by all people using or installing the equipment model. Contact the Alto-Shaam Tech Team Service Department if you have any questions concerning installation, operation, or maintenance.

NOTE: All claims for warranty must include the full model number and serial number of the unit.

UNPACKING

1. Carefully remove the appliance from the carton or crate.

NOTE: Do not discard the carton and other packaging material until you have inspected the unit for hidden damage and tested it for proper operation.

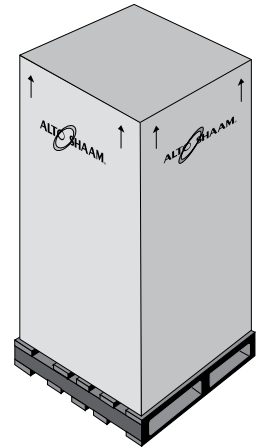

2. Read all instructions in this manual carefully before initiating the installation of this appliance.

DO NOT DISCARD THIS MANUAL.

This manual is considered to be part of the appliance and is to be provided to the owner or manager of the business or to the person responsible for training operators. *Additional manuals are available from the Alto-Shaam Tech Team Service Department.*

3. Remove all protective plastic film, packaging materials, and accessories from the appliance before connecting electrical power. Store any accessories in a convenient place for future use.

SAFETY PROCEDURES AND PRECAUTIONS

Knowledge of proper procedures is essential to the safe operation of electrically and/or gas energized equipment. In accordance with generally accepted product safety labeling guidelines for potential hazards, the following signal words and symbols may be used throughout this manual.

DANGER



Used to indicate the presence of a hazard that **WILL** cause severe personal injury, death, or substantial property damage if the warning included with this symbol is ignored.

WARNING



Used to indicate the presence of a hazard that **CAN** cause personal injury, possible death, or major property damage if the warning included with this symbol is ignored.

CAUTION



Used to indicate the presence of a hazard that can or will cause minor or moderate personal injury or property damage if the warning included with this symbol is ignored.

CAUTION

Used to indicate the presence of a hazard that can or will cause minor personal injury, property damage, or a potential unsafe practice if the warning included with this symbol is ignored.

NOTE: Used to notify personnel of installation, operation, or maintenance information that is important but not hazard related.

1. This appliance is intended to hold foods for the purpose of human consumption. No other use for this appliance is authorized or recommended.
2. This appliance is intended for use in commercial establishments where all operators are familiar with the purpose, limitations, and associated hazards of this appliance. Operating instructions and warnings must be read and understood by all operators and users.
3. Any troubleshooting guides, component views, and parts lists included in this manual are for general reference only and are intended for use by qualified technical personnel.
4. This manual should be considered a permanent part of this appliance. This manual and all supplied instructions, diagrams, schematics, parts lists, notices, and labels must remain with the appliance if the item is sold or moved to another location.

NOTE

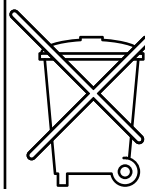

For equipment delivered for use in any location regulated by the following directive:

DO NOT DISPOSE OF ELECTRICAL OR ELECTRONIC EQUIPMENT WITH OTHER MUNICIPAL WASTE.



Used to indicate that referral to operating instructions is a mandatory action. If not followed the operator or patient could suffer personal injury.



Used to indicate that referral to operating instructions is recommended to understand operation of equipment.

INSTALLATION

SITE INSTALLATION

DANGER



IMPROPER INSTALLATION, ALTERATION, ADJUSTMENT, SERVICE, OR MAINTENANCE COULD RESULT IN SEVERE INJURY, DEATH, OR CAUSE PROPERTY DAMAGE.

READ THE INSTALLATION, OPERATING AND MAINTENANCE INSTRUCTIONS THOROUGHLY BEFORE INSTALLING OR SERVICING THIS EQUIPMENT.

CAUTION



TO PREVENT PERSONAL INJURY, USE CAUTION WHEN MOVING OR LEVELING THIS APPLIANCE.

CAUTION



METAL PARTS OF THIS EQUIPMENT BECOME EXTREMELY HOT WHEN IN OPERATION. TO AVOID BURNS, ALWAYS USE HAND PROTECTION WHEN OPERATING THIS APPLIANCE.

SITE INSTALLATION

In order to maintain standards established by the National Sanitation Foundation, all stationary counter-mounted equipment must be secured flush to the counter and the entire base sealed to the counter with NSF approved sealant or equipped with 4" (102mm) legs to provide minimum unobstructed space beneath the unit. Warranty will become null and void if these directions are not followed.

1. The appliance must be installed on a stable and level surface.
2. **DO NOT** install this appliance in any area where it may be affected by any adverse conditions such as steam, grease, dripping water, high temperatures, or any other severely adverse conditions.
3. **DO NOT** install a heated display case near a cold air source such as a freezer, air conditioning vents, or in any area where outside air fluctuation can affect performance.
4. This appliance must be kept free and clear of any obstructions blocking access for maintenance or service.

LEVELING

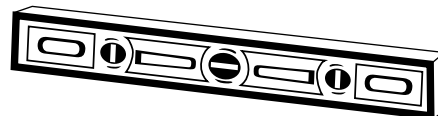

Level the appliance from side-to-side and front-to-back with the use of a spirit level.

We recommend checking the level periodically to make certain the floor has not shifted nor the appliance moved.

NOTE: Failure to properly level this appliance can cause improper function.

CLEARANCE REQUIREMENTS

BACK	3" (76mm)
TOP	2" (51mm)
EACH SIDE	1" (25mm)

WEIGHT

NET	76 lb (34kg)
SHIP	132 lb (60kg)
CARTON DIMENSIONS: (L X W X H)	
32" x 32" x 41" (813mm x 813mm x 1041mm)	

INSTALLATION

SITE INSTALLATION

Outside Dimensions

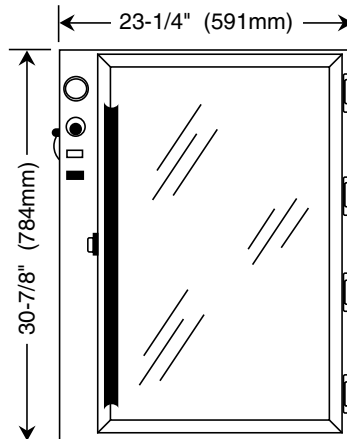
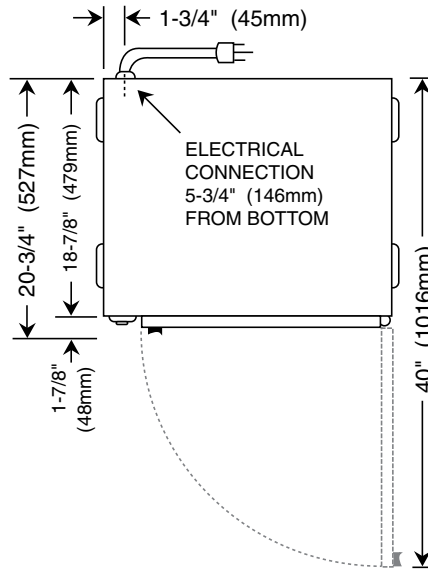

OPTIONS & ACCESSORIES



Caster Stand Assembly	15633
Leg Stand Assembly	15634
Shelf, Chrome plate, Wire	SH-2102
Solid door FACTORY INSTALLATION ONLY	15248

INSTALLATION

ELECTRICAL INSTALLATION

The appliance must be installed by a qualified service technician. The oven must be properly grounded in accordance with the National Electrical Code and applicable local codes.

DANGER

To avoid electrical shock, this appliance MUST be adequately grounded in accordance with local electrical codes or, in the absence of local codes, with the current edition of the National Electrical Code ANSI/NFPA No. 70. In Canada, all electrical connections are to be made in accordance with CSA C22.1, Canadian Electrical Code Part 1 or local codes.



Plug the unit into a properly grounded receptacle **ONLY**, positioning the unit so that the plug is easily accessible in case of an emergency. Arcing will occur when connecting or disconnecting the unit unless all controls are in the "OFF" position.

Proper receptacle or outlet configuration or permanent wiring for this unit must be installed by a licensed electrician in accordance with applicable local electrical codes.

REGARDING INTERNATIONAL STANDARD UNITS:



If the unit is not equipped with flexible cord with plug, an all-pole country approved disconnection device which has a contact separation of at least 3mm in all poles must be incorporated in the fixed wiring for disconnection. When using a cord without a plug, the green/yellow conductor shall be connected to the terminal which is marked with the ground symbol. If a plug is used, the socket outlet must be easily accessible. If the power cord needs replacement, use a similar one obtained from the distributor.

DANGER

ELECTRICAL CONNECTIONS MUST BE MADE BY A QUALIFIED SERVICE TECHNICIAN IN ACCORDANCE WITH APPLICABLE ELECTRICAL CODES.

DANGER

ENSURE POWER SOURCE MATCHES VOLTAGE IDENTIFIED ON APPLIANCE RATING TAG.



For CE approved units: To prevent an electrical shock hazard between the appliance and other appliances or metal parts in close vicinity, an equalization-bonding stud is provided. An equalization bonding lead must be connected to this stud and the other appliances/metal parts to provide sufficient protection against potential difference. The terminal is marked with the following symbol.





Hard wired models:

Hard wired models must be equipped with a country certified external allpole disconnection switch with sufficient contact separation.

If a power cord is used for the connection of the product an oil resistant cord like H05RN or H07RN or equivalent must be used.

NOTE: Where local codes and CE regulatory requirements apply, appliances must be connected to an electrical circuit that is protected by an external GFCI outlet.

ELECTRICAL						
VOLTAGE	PHASE	CYCLE/HZ	AMPS	kW		
125	1	50/60	8.3	1.00		NEMA 5-15P, 15A-125V PLUG
230	1	50/60	4.3	1.00		NEMA 6-15P, 15A-250V PLUG (USA ONLY)
						CEE 7/7, 220-230V PLUG

Wire diagrams are included in the literature package supplied with the unit.

OPERATION

USER SAFETY INFORMATION

This appliance is intended for use in commercial establishments where all operators are familiar with the purpose, limitations, and associated hazards of this appliance. Operating instructions and warnings must be read and understood by all operators and users.

Before Initial Use:

Clean appliance with a clean, damp cloth and mild soap solution. Glass cleaner or distilled vinegar can be used on the glass. Clean and install the cabinet wire shelves.

1. Make sure the unit is connected to the appropriate power source.

2. Turn thermostat to 200°F (93°C) and preheat for 30 minutes.

When the thermostat is turned clockwise to an "ON" position, the indicator light will illuminate and will remain lit as long as the unit is calling for heat.

The indicator light will go OUT when the air temperature inside the unit reaches the temperature set by the operator. It will then cycle "ON/OFF" at this holding point. Verify the full preheated temperature with the holding temperature gauge located on the control panel of the cabinet.

3. Load the cabinet with hot food only.

The purpose of the holding cabinet is to maintain hot food at proper serving temperature. Only hot food should be placed into the cabinet. Before loading the cabinet with food, use a food thermometer to make certain all products are at an internal temperature range of 140° to 160°F (60° to 71°C). Any food product not within the proper temperature range should be heated before loading into the holding cabinet.

4. Reset the thermostat to 160°F (71°C).

Check to make certain the cabinet door is securely closed, and reset the thermostat to 160°F (71°C). THIS WILL NOT NECESSARILY BE THE FINAL SETTING. The proper temperature range for the products being held will depend on the type and quantity of product. When holding food for prolonged periods, it is advisable to periodically check the internal temperature of each item with a food thermometer to assure maintenance of the proper temperature range of 140° to 160°F (60° to 71°C).

- Use hand protection when handling hot items.
- Be certain only hot foods are placed into the cabinet.
- To avoid personal injury and damage to the unit, treat glass with care.
- Remember — glass can shatter.

HEATING CHARACTERISTICS

The cabinet is equipped with a special, low heat density, heating cable. Through the Halo Heat concept, the heating cable is mounted against the walls of the warming compartment to provide an evenly applied, thermostat controlled, heat source. The design and operational characteristics of the cabinet eliminate the need for a moisture pan or a heat circulating fan. Through even heat application, the quality of a food product is maintained up to several hours.

CAUTION



METAL PARTS OF THIS EQUIPMENT BECOME EXTREMELY HOT WHEN IN OPERATION. TO AVOID BURNS, ALWAYS USE HAND PROTECTION WHEN OPERATING THIS APPLIANCE.

PRODUCT CAPACITY

MAXIMUM: Thirteen (13) 16" (406mm) Pizzas
MAXIMUM WEIGHT EACH PIZZA: 2 lbs. (.9kg)

OPERATION

GENERAL HOLDING GUIDELINES

Chefs, cooks and other specialized food service personnel employ varied methods of cooking. Proper holding temperatures for a specific food product must be based on the moisture content of the product, product density, volume, and proper serving temperatures. Safe holding temperatures must also be correlated with palatability in determining the length of holding time for a specific product.

Halo Heat maintains the maximum amount of product moisture content without the addition of water, water vapor, or steam. Maintaining maximum natural product moisture preserves the natural flavor of the product and provides a more genuine taste. In addition to product moisture retention, the gentle properties of Halo Heat maintain a consistent temperature throughout the cabinet without the necessity of a heat distribution fan, thereby preventing further moisture loss due to evaporation or dehydration.

When product is removed from a high temperature cooking environment for immediate transfer into equipment with the lower temperature required for hot food holding, condensation can form on the outside of the product and on the inside of plastic containers used in self-service applications. Allowing the product to release the initial steam and heat produced by high temperature cooking can alleviate this condition. To preserve the safety and quality of freshly cooked foods however, a maximum of 1 to 2 minutes must be the only time period allowed for the initial heat to be released from the product.

This unit is equipped with a thermostat control between 60° and 200°F (16° and 93°C). If the unit is equipped with vents, close the vents for moist holding and open the vents for crisp holding. Use a metal-stemmed thermometer to measure the internal temperature of the product being held. Adjust the thermostat setting to achieve the best overall setting based on internal product temperature.

HOLDING TEMPERATURE RANGE		
MEAT	FAHRENHEIT	CELSIUS
BEEF ROAST — Rare	130°F	54°C
BEEF ROAST — Med/Well Done	155°F	68°C
BEEF BRISKET	160° — 175°F	71° — 79°C
CORN BEEF	160° — 175°F	71° — 79°C
PASTRAMI	160° — 175°F	71° — 79°C
PRIME RIB — Rare	130°F	54°C
STEAKS — Broiled/Fried	140° — 160°F	60° — 71°C
RIBS — Beef or Pork	160°F	71°C
VEAL	160° — 175°F	71° — 79°C
HAM	160° — 175°F	71° — 79°C
PORK	160° — 175°F	71° — 79°C
LAMB	160° — 175°F	71° — 79°C
POULTRY		
CHICKEN — Fried/Baked	160° — 175°F	71° — 79°C
DUCK	160° — 175°F	71° — 79°C
TURKEY	160° — 175°F	71° — 79°C
GENERAL	160° — 175°F	71° — 79°C
FISH/SEAFOOD		
FISH — Baked/Fried	160° — 175°F	71° — 79°C
LOBSTER	160° — 175°F	71° — 79°C
SHRIMP — Fried	160° — 175°F	71° — 79°C
BAKED GOODS		
BREADS/ROLLS	120° — 140°F	49° — 60°C
MISCELLANEOUS		
CASSEROLES	160° — 175°F	71° — 79°C
DOUGH — Proofing	80° — 100°F	27° — 38°C
EGGS — Fried	150° — 160°F	66° — 71°C
FROZEN ENTREES	160° — 175°F	71° — 79°C
HORS D'OEUVRES	160° — 180°F	71° — 82°C
PASTA	160° — 180°F	71° — 82°C
PIZZA	160° — 180°F	71° — 82°C
POTATOES	180°F	82°C
PLATED MEALS	140° — 165°F	60° — 74°C
SAUCES	140° — 200°F	60° — 93°C
SOUP	140° — 200°F	60° — 93°C
VEGETABLES	160° — 175°F	71° — 79°C
THE HOLDING TEMPERATURES LISTED ARE SUGGESTED GUIDELINES ONLY. ALL FOOD HOLDING SHOULD BE BASED ON INTERNAL PRODUCT TEMPERATURES. ALWAYS FOLLOW LOCAL HEALTH (HYGIENE) REGULATIONS FOR ALL INTERNAL TEMPERATURE REQUIREMENTS.		

CARE AND CLEANING

CLEANING AND PREVENTATIVE MAINTENANCE

PROTECTING STAINLESS STEEL SURFACES



It is important to guard against corrosion in the care of stainless steel surfaces. Harsh, corrosive, or inappropriate chemicals can completely destroy the protective surface layer of stainless steel. Abrasive

pads, steel wool, or metal implements will abrade surfaces causing damage to this protective coating and will eventually result in areas of corrosion. Even water, particularly hard water that contains high to moderate concentrations of chloride, will cause oxidation and pitting that result in rust and corrosion. In addition, many acidic foods spilled and left to remain on metal surfaces are contributing factors that will corrode surfaces.





Proper cleaning agents, materials, and methods are vital to maintaining the appearance and life of this appliance. Spilled foods should be removed and the area wiped as soon as possible but at the very least, a minimum of once a day. Always thoroughly rinse surfaces after using a cleaning agent and wipe standing water as quickly as possible after rinsing.

CLEANING AGENTS

Use non-abrasive cleaning products designed for use on stainless steel surfaces. Cleaning agents must be chloride-free compounds and must not contain quaternary salts. Never use hydrochloric acid (muriatic acid) on stainless steel surfaces. Always use the proper cleaning agent at the manufacturer's recommended strength. Contact your local cleaning supplier for product recommendations.

CLEANING MATERIALS

The cleaning function can usually be accomplished with the proper cleaning agent and a soft, clean cloth. When more aggressive methods must be employed, use a non-abrasive scouring pad on difficult areas and make certain to scrub with the visible grain of surface metal to avoid surface scratches. Never use wire brushes, metal scouring pads, or scrapers to remove food residue.

 CAUTION	
 NO SCRAPERS	TO PROTECT STAINLESS STEEL SURFACES, COMPLETELY AVOID THE USE OF ABRASIVE CLEANING COMPOUNDS, CHLORIDE BASED CLEANERS, OR CLEANERS CONTAINING QUATERNARY SALTS. NEVER USE HYDROCHLORIC ACID (MURIATIC ACID) ON STAINLESS STEEL. NEVER USE WIRE BRUSHES, METAL SCOURING PADS OR SCRAPERS.
 NO WIRE BRUSHES	
 NO STEEL PADS	

CARE AND CLEANING



The cleanliness and appearance of this equipment will contribute considerably to operating efficiency and savory, appetizing food. Good equipment that is kept clean works better and lasts longer.

CLEAN THE HOLDING CABINET DAILY:

1. Disconnect unit from power source, and let cool.
2. Remove shelves. Clean shelves separately with a good grease solvent or commercial detergent. Rinse well and dry.
3. Clean interior metal surfaces of the unit with a damp, clean cloth and any good commercial detergent or grease solvent at the recommended strength. Spray heavily soiled areas with a water soluble degreaser and let stand for 10 minutes, then remove soil with a plastic scouring pad. Rinse by wiping with a Sponge and clean warm water to remove all residue. Remove excess water with sponge and wipe dry with a clean cloth or air dry. Replace side racks and shelves.
4. Clean control panel, door handles, and door gaskets thoroughly since these areas harbor food debris. Rinse by wiping with sponge and clean warm water. Wipe dry with a clean cloth.
5. Interior can be wiped with a sanitizing solution after cleaning and rinsing. This solution must be approved for use on stainless steel food contact surfaces.
6. To help maintain the protective film coating on polished stainless steel, clean the exterior of the unit with a cleaner recommended for stainless steel surfaces. Spray the cleaning agent on a clean cloth and wipe with the grain of the stainless steel.



NOTE: Avoid the use of abrasive cleaning, compounds, chloride based cleaners, or cleaners containing quaternary salts. Never use hydrochloric acid (muriatic acid) on stainless steel.

Always follow appropriate state or local health (hygiene) regulations regarding all applicable cleaning and sanitation requirements for foodservice equipment.

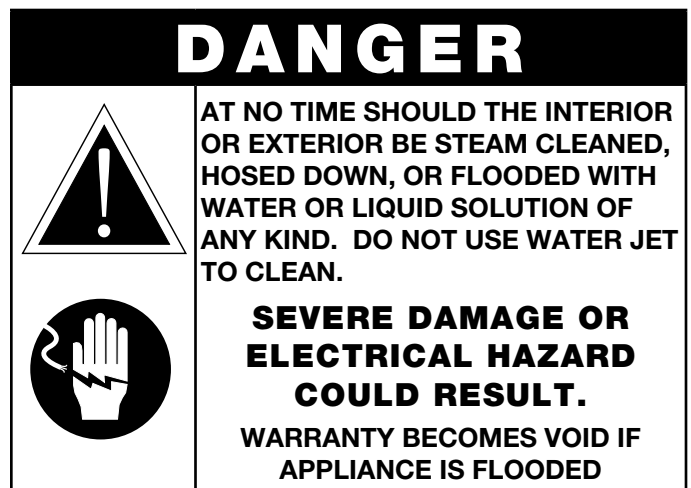
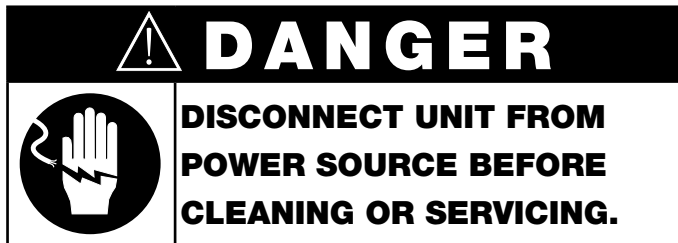

SANITATION

Food flavor and aroma are usually so closely related that it is difficult, if not impossible, to separate them. There is also an important, inseparable relationship between cleanliness and food flavor. Cleanliness, top operating efficiency, and appearance of equipment contribute considerably to savory, appetizing foods. Good equipment that is kept clean, works better and lasts longer.

Most food imparts its own particular aroma and many foods also absorb existing odors. Unfortunately, during this absorption there is not distinction between GOOD and BAD odors. The majority of objectionable flavors and odors troubling food service operations are caused by bacteria growth. Sourness, rancidity, mustiness, stale or other OFF flavors are usually the result of germ activity.

The easiest way to insure full, natural food flavor is through comprehensive cleanliness. This means good control of both visible soil (dirt) and invisible soil (germs). A through approach to sanitation will provide essential cleanliness. It will assure an attractive appearance of equipment, along with maximum efficiency and utility. More importantly, a good sanitation program provides one of the key elements in the prevention of food-borne illnesses.

A controlled holding environment for prepared foods is just one of the important factors involved in the prevention of food-borne illnesses. Temperature monitoring and control during receiving, storage, preparation, and the service of foods are of equal importance.

The most accurate method of measuring safe temperatures of both hot and cold foods is by internal product temperature. A quality thermometer is an effective tool for this purpose, and should be routinely used on all products that require holding at a specific temperature.

A comprehensive sanitation program should focus on the training of staff in basic sanitation procedures. This includes personal hygiene, proper handling of raw foods, cooking to a safe internal product temperature, and the routine monitoring of internal temperatures from receiving through service.

Most food-borne illnesses can be prevented through proper temperature control and a comprehensive program of sanitation. Both these factors are important to build quality service as the foundation of customer satisfaction. Safe food handling practices to prevent food-borne illness is of critical importance to the health and safety of your customers.

HACCP, an acronym for Hazard Analysis (at) Critical Control Points, is a quality control program of operating procedures to assure food integrity, quality, and safety. Taking steps necessary to augment food safety practices is both cost effective and relatively simple. While HACCP guidelines go far beyond the scope of this manual, additional information is available by contacting:

**CENTER FOR FOOD SAFETY AND APPLIED
NUTRITION FOOD AND DRUG ADMINISTRATION
1-888-SAFEFOOD**

INTERNAL FOOD PRODUCT TEMPERATURES		
HOT FOODS		
DANGER ZONE	40° TO 140°F	(4° TO 60°C)
CRITICAL ZONE	70° TO 120°F	(21° TO 49°C)
SAFE ZONE	140° TO 165°F	(60° TO 74°C)
COLD FOODS		
DANGER ZONE	ABOVE 40°F	(ABOVE 4°C)
SAFE ZONE	36° TO 40°F	(2° TO 4°C)
FROZEN FOODS		
DANGER ZONE	ABOVE 32°F	(ABOVE 0°C)
CRITICAL ZONE	0° TO 32°F	(-18° TO 0°C)
SAFE ZONE	0°F or below	(-18°C or below)

SERVICE

THERMOSTAT & INDICATOR LIGHT SEQUENCE

Whenever the thermostat is turned "ON," the indicator light will indicate the power ON/OFF condition of the heating cable, and consequently, the cycling of the cabinet as it maintains the dialed cavity temperature. If this light does not illuminate after normal start-up, the main power source, thermostat, and/or indicator light must be checked. If the warming cabinet does not hold the temperature as dialed, the calibration of the thermostat must be checked. If the warming cabinet fails to heat or heats continuously with the thermostat "OFF," the thermostat must be initially checked for proper operation. If these items are checked and found to be in order, a continuity and resistance check of the heating cable should be made. SEE WIRE DIAGRAM INCLUDED WITH THE UNIT.



THERMOSTAT CALIBRATION

The thermostat is precision calibrated at the factory. Normally, no adjustment or recalibration is necessary unless the thermostat has been mishandled in transit, changed or abused while in service. A thermostat with a sensing bulb operates on hydraulic pressure, consequently, any bending of the bulb results in a change in its volume, and alters the accuracy of the thermostat calibration.

A thermostat should be checked or recalibrated by placing a quality, thermal indicator at the center of an empty holding cavity. **DO NOT CALIBRATE WITH ANY FOOD PRODUCT IN THE CABINET.** The thermostat should be set, and should be allowed to stabilize at that setting for a minimum of one hour. The center of the thermal swing of the air temperature within the cabinet should approximately coincide with the thermostat setting.

If calibration is necessary, the calibration screw should be adjusted with great care. The calibration screw of the thermostat is located in the thermostat dial shaft. With the shaft held stationary, a minute, clockwise motion of the calibration screw appreciably lowers the thermostat setting. A reverse, or counter-clockwise motion appreciably raises the thermostat setting. After achieving the desired cycling of the thermostat, the calibration screw must be sealed. Place a few drops of enamel sealant directly on the calibration screw. (*Red nail polish or equivalent is acceptable.*)

SERVICE

SERVICE PARTS LIST

ITEM	DESCRIPTION	PART NO.	QTY	ITEM	DESCRIPTION	PART NO.	QTY
1	CARRYING HANDLE	HD-2021	4	13	THERMOSTAT	TT-3057	1
	CARRYING HANDLE MTG SCREWS	SC-2070	16		THERMOSTAT KNOB (Fahrenheit)	KN-3469	1
2	CASING MOUNTING RIVETS	RI-2100	20		THERMOSTAT KNOB (Celsius)	KN-3474	1
3	INLET (125V)	IT-3001	1	14	TEMPERATURE GAUGE	GU-3273	1
	INLET (230V)	IT-33173	1	15	SHELF	SH-2102	13
4	INSULATION, 18" x 82" (457mm x 2082mm)	IN-2381	1	16	CABLE CONNECTION HARDWARE	AVAILABLE	1
5	GLASS DOOR MOUNTING SCREWS	SC-2425	12	17	CORD AND PLUG SET (125V)	CD-3029	1
6	HINGE SET (1 pair of 2 hinges), GLASS DR.	HG-2047	2		CORDSET: 230V INTL (TYPE HO7 RN-F)	CD-3984	1
	HINGE MOUNTING SCREWS	SC-2470	8		CORDSET: 230V (FOR USA USAGE)	CD-3858	1
7	DOOR GASKET, GLASS DOOR	GS-28469	1	18	HEATING CABLE, 107' (32614mm)	CB-3044	1
8	GLASS DOOR ASSEMBLY	4100	1	19	CASING	1365	1
9	DOOR HANDLE	HD-2008	1		CASING BOTTOM	1383	1
	DOOR HANDLE MOUNTING SCREWS	SC-2664	2		CASING BACK	1393	1
10	DOOR LATCH	LT-2040	1	20*	DOOR, SOLID, RH	15248	1
	DOOR LATCH MOUNTING SCREWS	SC-2239	4		DOOR GASKET (15248), SOLID DOOR	GS-2398	9 FT
11	POWER SWITCH	SW-3887	1		HINGE SET, RH SOLID DOOR (15248)	HG-2015	2
12	HEAT INDICATOR LIGHT (125V)	LI-3493	1				
	HEAT INDICATOR LIGHT (230V)	LI-3923	1				

* NOT SHOWN

CABLE HEATING SERVICE KIT - NO. 4874		
KIT INCLUDES:	PART NO.	QTY.
Cable Heating Element	CB-3044	120 feet (3658cm)
Ring Connector	CR-3226	4
Insulation Corner	IN-3488	1 foot (30,5cm)
Shoulder Bushing	BU-3105	4
Cup Bushing	BU-3106	4
Stud	ST-2439	4
Hex Nut	NU-2215	8
Insulating Sleeve	SL-3063	4
Electrical Tape	TA-3540	1 roll

500-PH/GD
SERVICE VIEW

5/64" = 1"

7-14-89

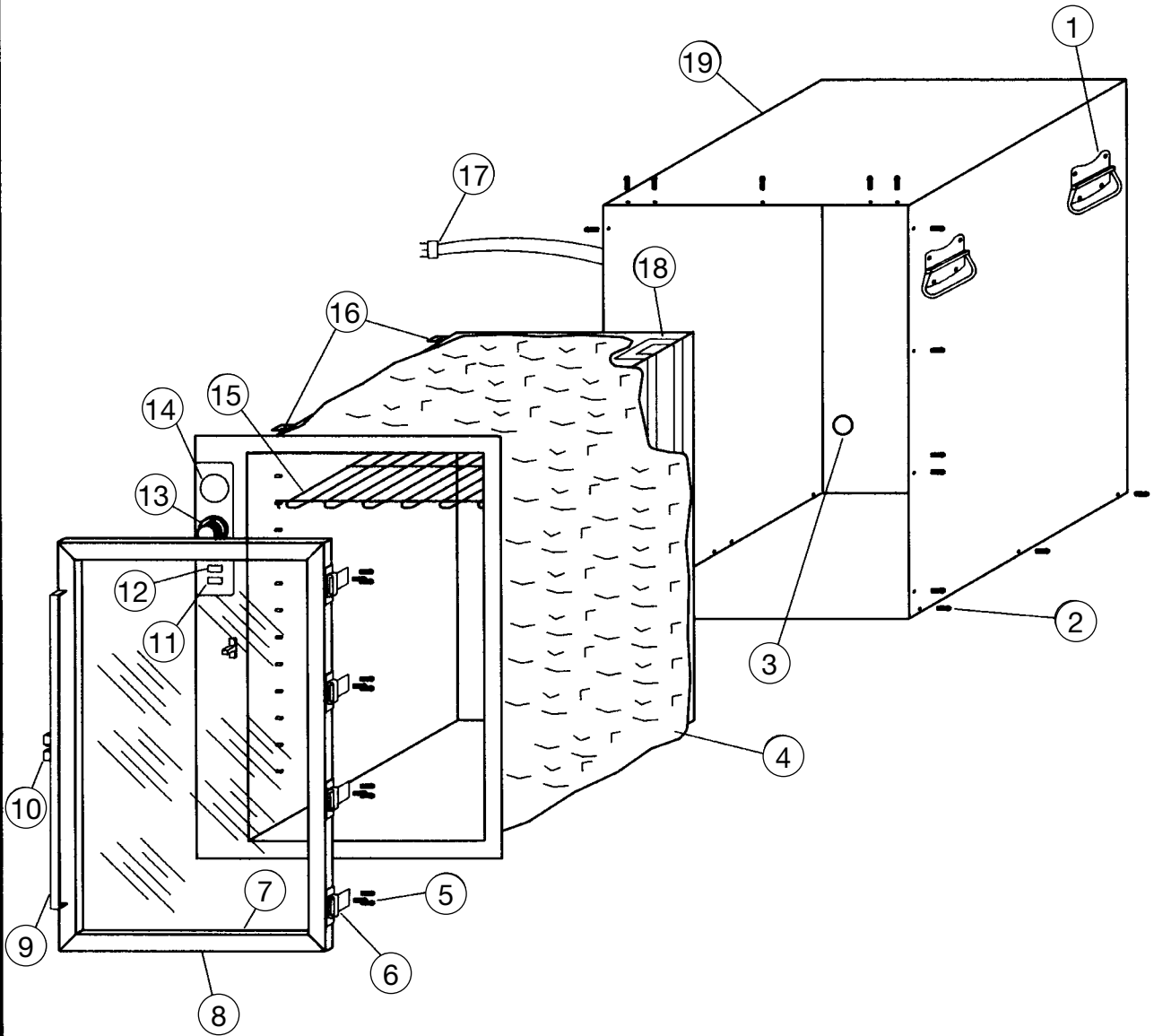

Part numbers and drawings are subject to change without notice.

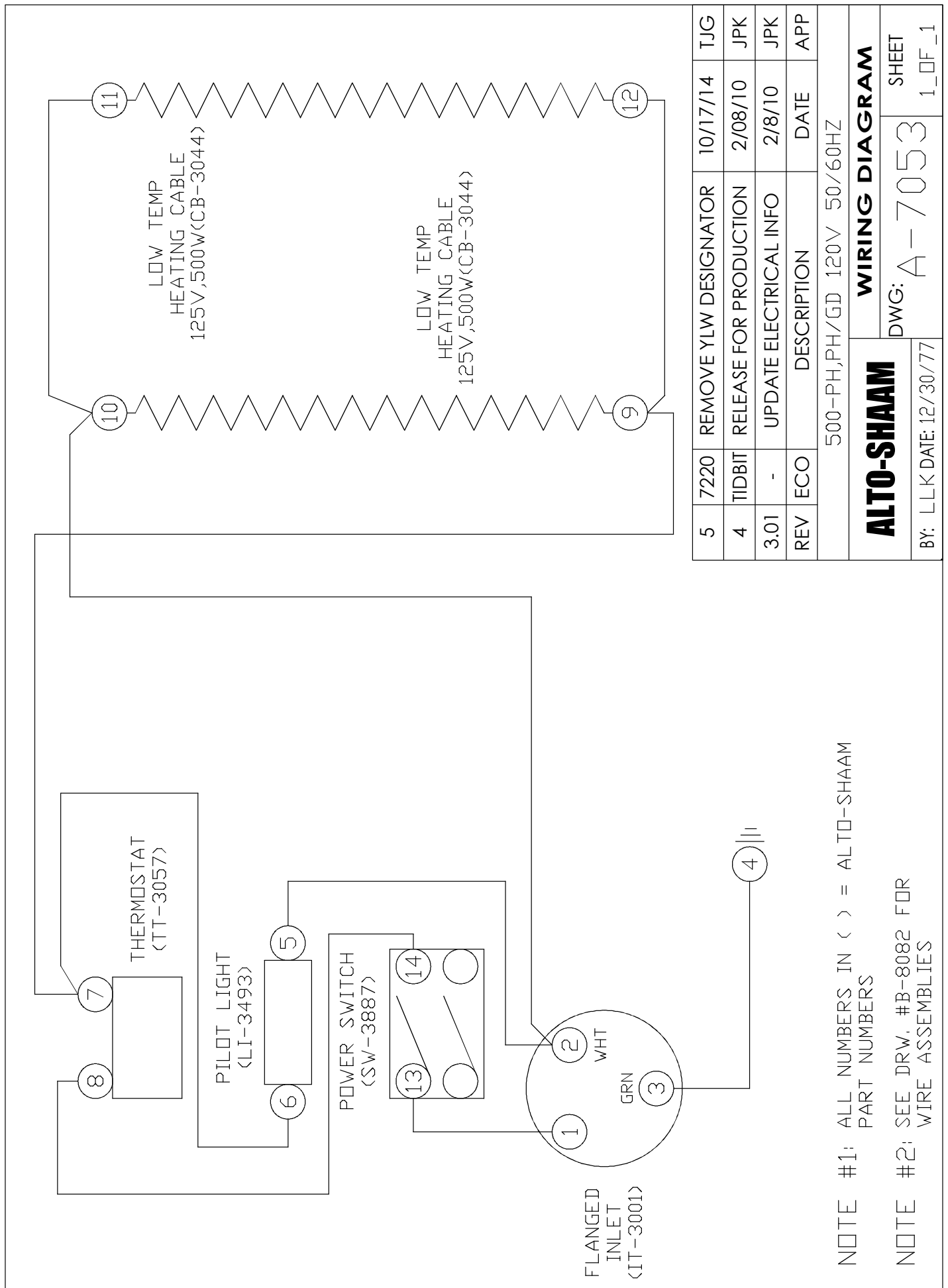

5	7220	REMOVE YLW DESIGNATOR	10/17/14	TJG
4	TIDBIT	RELEASE FOR PRODUCTION	2/08/10	JPK
3.01	-	UPDATE ELECTRICAL INFO	2/8/10	JPK
REV	ECO	DESCRIPTION	DATE	APP
500-PH,PH/GD 120V 50/60HZ				
ALTO-SHAAM		WIRING DIAGRAM		
BY: L L K DATE: 12/30/77			DWG: A-7053	
			SHEET 1_OF_1	

NOTE #1: ALL NUMBERS IN () = ALTO-SHAAM PART NUMBERS

NOTE #2: SEE DRW. #B-8082 FOR WIRE ASSEMBLIES

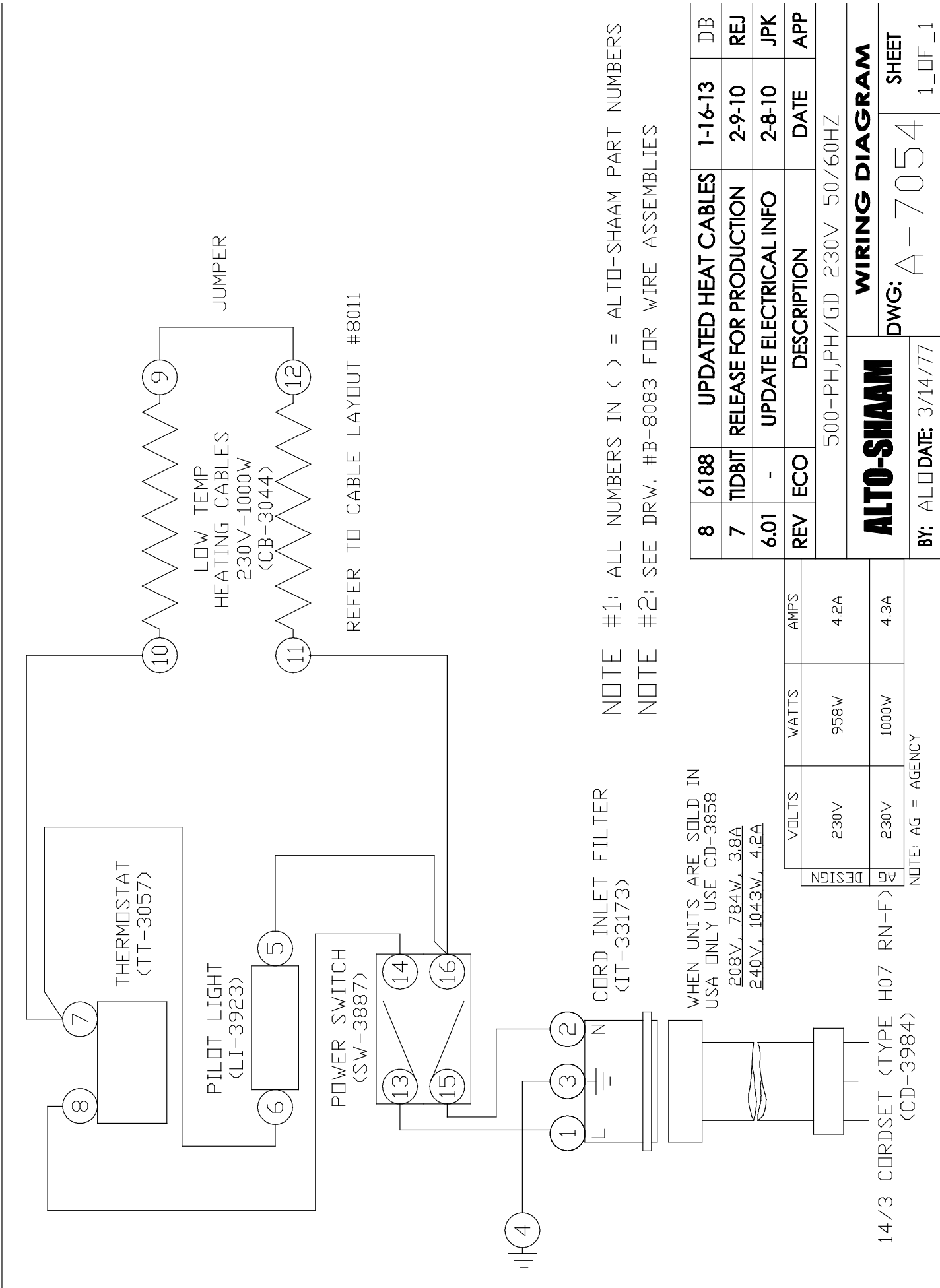

NOTE #1: ALL NUMBERS IN () = ALTO-SHAAM PART NUMBERS
 NOTE #2: SEE DRW. #B-8083 FOR WIRE ASSEMBLIES

8	6188	UPDATED HEAT CABLES	1-16-13	DB
7	TIDBIT	RELEASE FOR PRODUCTION	2-9-10	REJ
6.01	-	UPDATE ELECTRICAL INFO	2-8-10	JPK
REV	ECO	DESCRIPTION	DATE	APP
500-PH,PH/GD 230V 50/60HZ				
ALTO-SHAAM			WIRING DIAGRAM	
BY: AL DATE: 3/14/77			DWG: A-7054 SHEET 1_OF_1	

WHEN UNITS ARE SOLD IN USA ONLY USE CD-3858
 208V, 784W, 3.8A
 240V, 1043W, 4.2A

VOLTS	WATTS	AMPS
230V	958W	4.2A
230V	1000W	4.3A

NOTE: AG = AGENCY

TRANSPORTATION DAMAGE and CLAIMS



All Alto-Shaam equipment is sold F.O.B. shipping point, and when accepted by the carrier, such shipments become the property of the consignee.

Should damage occur in shipment, it is a matter between the carrier and the consignee. In such cases, the carrier is assumed to be responsible for the safe delivery of the merchandise, unless negligence can be established on the part of the shipper.

1. Make an immediate inspection while the equipment is still in the truck or immediately after it is moved to the receiving area. Do not wait until after the material is moved to a storage area.
2. Do not sign a delivery receipt or a freight bill until you have made a proper count and inspection of all merchandise received.
3. Note all damage to packages directly on the carrier's delivery receipt.
4. Make certain the driver signs this receipt. If he refuses to sign, make a notation of this refusal on the receipt.
5. If the driver refuses to allow inspection, write the following on the delivery receipt:
Driver refuses to allow inspection of containers for visible damage.
6. Telephone the carrier's office immediately upon finding damage, and request an inspection. Mail a written confirmation of the time, date, and the person called.
7. Save any packages and packing material for further inspection by the carrier.
8. Promptly file a written claim with the carrier and attach copies of all supporting paperwork.

We will continue our policy of assisting our customers in collecting claims which have been properly filed and actively pursued. We cannot, however, file any damage claims for you, assume the responsibility of any claims, or accept deductions in payment for such claims.

LIMITED WARRANTY

Alto-Shaam, Inc. warrants to the original purchaser only that any original part that is found to be defective in material or workmanship will, at Alto-Shaam's option, subject to provisions hereinafter stated, be replaced with a new or rebuilt part.

The original parts warranty period is as follows:

For the refrigeration compressor on Alto-Shaam Quickchillers™, five (5) years from the date of installation of appliance.

For the heating element on Halo Heat® cooking and holding ovens, as long as the original purchaser owns the oven. This excludes holding only equipment.

For all other original parts, one (1) year from the date of installation of appliance or fifteen (15) months from the shipping date, whichever occurs first.

The labor warranty period is one (1) year from the date of installation or fifteen (15) months from the shipping date, whichever occurs first.

Alto-Shaam will bear normal labor charges performed during standard business hours, excluding overtime, holiday rates or any additional fees.

To be valid, a warranty claim must be asserted during the applicable warranty period. This warranty is not transferable.

THIS WARRANTY DOES NOT APPLY TO:

1. Calibration.
2. Replacement of light bulbs, door gaskets, and/or the replacement of glass due to damage of any kind.
3. Equipment damage caused by accident, shipping, improper installation or alteration.
4. Equipment used under conditions of abuse, misuse, carelessness or abnormal conditions, including but not limited to, equipment subjected to harsh or inappropriate chemicals, including but not limited to, compounds containing chloride or quaternary salts, poor water quality, or equipment with missing or altered serial numbers.
5. Damage incurred as a direct result of poor water quality, inadequate maintenance of steam generators and/or surfaces affected by water quality. Water quality and required maintenance of steam generating equipment is the responsibility of the owner/operator.
6. Damage caused by use of any cleaning agent other than Alto-Shaam's Combitherm® Cleaner, including but not limited to damage due to chlorine or other harmful chemicals. **Use of Alto-Shaam's Combitherm® Cleaner on Combitherm® ovens is highly recommended.**
7. Any losses or damage resulting from malfunction, including loss of product, food product, revenue, or consequential or incidental damages of any kind.
8. Equipment modified in any manner from original model, substitution of parts other than factory authorized parts, removal of any parts including legs, or addition of any parts.

This warranty is exclusive and is in lieu of all other warranties, express or implied, including the implied warranties of merchantability and fitness for a particular purpose. In no event shall Alto-Shaam be liable for loss of use, loss of revenue or profit, or loss of product, or for any indirect, special, incidental, or consequential damages. No person except an officer of Alto-Shaam, Inc. is authorized to modify this warranty or to incur on behalf of Alto-Shaam any other obligation or liability in connection with Alto-Shaam equipment.



Effective November 1, 2012

RECORD THE MODEL AND SERIAL NUMBER OF THE APPLIANCE FOR EASY REFERENCE.

ALWAYS REFER TO BOTH MODEL AND SERIAL NUMBER IN ANY CONTACT WITH ALTO-SHAAM REGARDING THIS APPLIANCE.

Model: _____ Date Installed: _____
Voltage: _____ Purchased From: _____
Serial Number: _____

W164 N9221 Water Street • P.O. Box 450 • Menomonee Falls, Wisconsin 53052-0450 • U.S.A.
PHONE: 262.251.3800 • 800.558-8744 USA/CANADA FAX: 262.251.7067 • 800.329.8744 U.S.A. ONLY
www.alto-shaam.com

PRINTED IN U.S.A.