

Operating Instructions

NE-1027/NE-1037
1000 Watts Microwave Oven

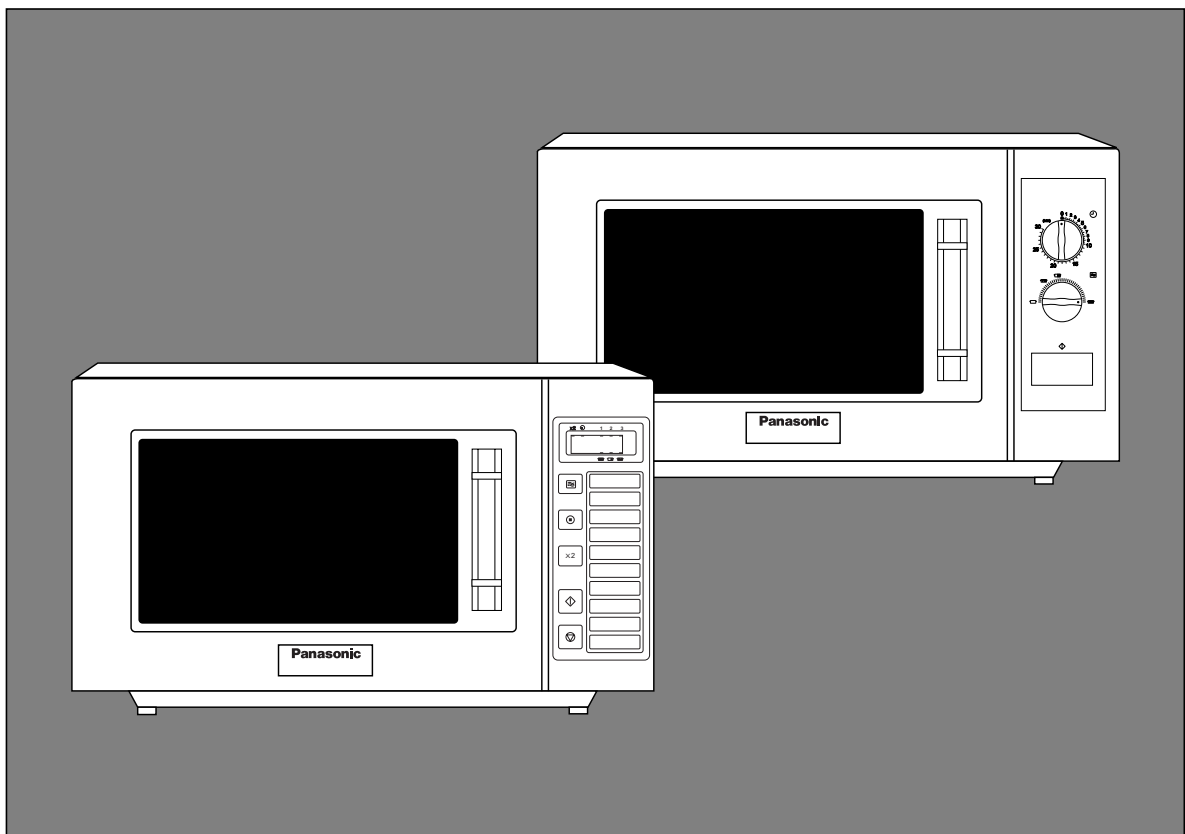



Panasonic®

Please read these instructions completely before operating this oven.

Table of Contents

For Your Safety	2
Unpacking Your Oven	2
Placement of Your Oven	3
Using Your Oven	3
Maintenance of Your Oven	3
Important Information —Read Carefully	4 - 5
How Does the Microwave Work?	6
- NE-1027 -	
Outline Diagram	7
How to Operate	7
- NE-1037 -	
Outline Diagram	9
How to Operate	
Before Operating	10
Heating	
A. Manual Single Stage Heating	11
B. Manual 2 or 3 Stages Heating	11
C. Programmed Heating	12
Programming	
A. Programming Memory Pads for Single Stage Heating	13
B. Programming Memory Pads for 2 or 3 Stages Heating	14
C. Programming the Double Quantity Pad	15
Other Features	
A. To Activate Program Lock	16
B. To Release Program Lock	16
C. To Read Program List	17
D. To Select Beep Tone Options	18
E. To Read the Cycle Counter	18
Self Diagnostics Failure Code	19
Care of Your Microwave Oven	19
Cooking/Defrosting Guide	20
Technical Specifications	21

For Your Safety

This appliance is supplied with a moulded three pin mains plug for your safety and convenience. A 13 amp fuse is fitted in this plug. Should the fuse need to be replaced, please ensure that the replacement fuse has a rating of 13 amps and that it is approved by ASTA or BSI to BS1362. Check for the ASTA mark  or the BSI mark  on the body of the fuse.

If the fuse cover is detachable, never use the plug with the cover omitted. If a replacement fuse cover is required, ensure that it is the same colour as that visible on the face of the plug (i.e. Red or Orange). A replacement fuse cover can be purchased from your local Panasonic Dealer.

HOW TO REPLACE THE FUSE

Open the fuse compartment with a screwdriver and replace the fuse.

IF THE FITTED MOULDED PLUG IS UNSUITABLE FOR THE SOCKET OUTLET IN YOUR HOME THEN THE FUSE SHOULD BE REMOVED AND THE PLUG CUT OFF AND DISPOSED OF SAFELY AND AN APPROPRIATE ONE FITTED. THERE IS A DANGER OF SEVERE ELECTRICAL SHOCK IF THE CUT OFF PLUG IS INSERTED INTO ANY 13 AMP SOCKET.

If a new plug is to be fitted, please observe the wiring code as shown to the right above. If in any doubt, please consult a qualified electrician. (For U.K. Models only)

WARNING: THIS APPLIANCE MUST BE EARTHED.

IMPORTANT: The wires in this mains lead are coloured in accordance with the following code:

Green-and-yellow:	Earth
Blue:	Neutral
Brown:	Live

As the colours of the wire in the mains lead of this appliance may not correspond with the coloured markings identifying the terminals in your plug, proceed as follows:

The wire which is coloured GREEN-AND-YELLOW must be connected to the terminal in the plug which is marked with the letter E or by the Earth symbol  or coloured GREEN or GREEN-AND-YELLOW.

The wire which is coloured BLUE must be connected to the terminal in the plug which is marked with the letter N or coloured BLACK.

The wire which is coloured BROWN must be connected to the terminal in the plug which is marked with the letter L or coloured RED.

Voltage & Power

The voltage used must be the same as specified on this microwave oven. Using a higher voltage than that which is specified is dangerous and may result in a fire or other type of accident causing damage.

Do not immerse cord, plug or oven in water. Keep cord away from heated surfaces. Do not let cord hang over the edge of table or worktop. Do not plug your oven in via an extension cable as this can be dangerous. It is important to plug the oven directly into a wall socket.

The back of the appliance heats up during use. Do not allow the cord to be in contact with the back of the appliance or cabinet surface.

Unpacking Your Oven

1. Examine Your Oven

Unpack the oven, remove all packing material, and examine the oven for any damage such as dents, broken door latches or cracks in the door. Notify dealer immediately if the unit is damaged. DO NOT install it if the unit is damaged.

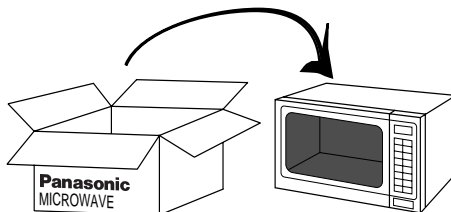

2. Guarantee Card

Fill out and post the pre-addressed guarantee card.



3. Cord

If the supply cord of this appliance is damaged, it must be replaced by the special cord available only from the manufacturer.

N.B. The appliance should be inspected for damage to the door seals and door seal areas and if these areas are damaged the appliance should not be operated until it has been repaired by service technician trained by the manufacturer.

4. Removal of protective film

A protective film is used to prevent scratching of the outer case during transportation. Peel this film off before installation or use.

DO NOT REMOVE THE ADHESIVE PLASTIC FILM FROM THE INSIDE OF THE DOOR.

Placement of Your Oven

1. Oven must be placed on a flat, stable surface. For proper operation, the oven must have sufficient air flow, i.e. 5 cm/2" at the side; 15 cm/6" clear over the top; 10 cm/4" at the rear.
2. Do not place the microwave oven on a shelf directly above a gas or electric hob. This may be a safety hazard and the oven may be damaged.
3. Do not block air vents on the rear and bottom of the cabinet. If air vents are blocked during operation, the oven may overheat. If the oven overheats, a thermal safety device will turn the oven off. The oven will remain inoperable with blank display until it has cooled.
4. Do not use the oven outdoors.

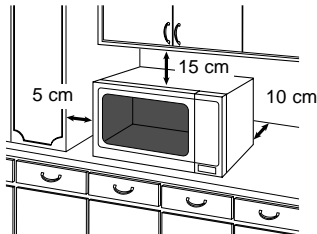

Using Your Oven

1. This oven must not be operated by Microwave without food in the oven. Operation when empty will damage the appliance.
2. Children should be kept away from the oven at all times and should only be allowed to operate the oven under supervision. Ensure that children do not touch the hot outer casing after operation of the oven.



3. Storage of accessories. Do not store any objects other than oven accessories inside the oven in case it is accidentally turned on. In case of electronic failure, the oven can be turned off at wall socket.
4. Do not dry fabrics in the oven since there is a possibility of the clothes burning if left in the oven for too long.
5. If smoke is observed, press the **Stop/Reset** Pad or turn the **Timer Select Dial** back to zero "0" position and leave the door closed. Disconnect the power cord, or shut off the power at the fuse or circuit breaker panel.

Maintenance of Your Oven

1. WHEN YOUR OVEN REQUIRES A SERVICE call your local Panasonic engineer (0541-591590) for Customer support. It is dangerous for anyone other than a service technician trained by the manufacturer to perform repair service. Do not attempt to remove the outer casing after operation of the oven.
2. Do not attempt to tamper with or make any adjustments or repairs to the door, control panel housing, safety interlock switches or any other part of the oven. **Do not remove outer panel from the oven.** The door seals and door seal areas should always be kept clean — use a damp cloth.
3. The oven lamp must be replaced by a service technician trained by the manufacturer. DO NOT attempt to remove the outer casing from the oven.



Important Information — Read Carefully

Short Cooking Times

As microwave cooking times are much shorter than other cooking methods it is essential that recommended cooking times are not exceeded without first checking the food.

Factors that may affect cooking times are: preferred degree of cooking, starting temperature, altitude, volume, size and shape of foods and utensils used. As you become familiar with the oven, you will be able to adjust these factors.

It is better to undercook rather than overcook foods. If food is undercooked, it can always be returned to the oven for further cooking. If food is overcooked, nothing can be done. Always start with minimum cooking times.

IMPORTANT

If the recommended cooking times are exceeded, the food will be spoiled and in extreme circumstances it could catch fire and possibly damage the interior of the oven.

1. Small Quantities of Food

Take care when heating small quantities of food as these can easily burn, dry out or catch on fire if cooked too long. Always set short cooking times and check the food frequently.

N.B. If materials inside the oven should ignite, keep the oven door closed, turn the oven off.



Disconnect the power cord, or shut off the power at the fuse or circuit breaker panel.

NEVER OPERATE THE OVEN WITHOUT FOOD.

2. Foods Low in Moisture

Take care when heating foods low in moisture, e.g. bread items, chocolate, popcorn, biscuits and pastries. These can easily burn, dry out or catch on fire if cooked too long.

3. Christmas Pudding

Christmas puddings and other foods high in fats or sugar, e.g. jam, mince pies, must not be over heated. These foods must never be left unattended as with over cooking these foods can ignite.

4. Boiled Eggs

Do not boil eggs in their shells and whole hard-boiled eggs in your microwave. Raw eggs boiled in their shells can explode causing injury.



5. Foods with Skins

Potatoes, apples, egg yolk, whole vegetables and sausages are examples of food with non porous skins. These must be pierced using a fork before cooking to prevent bursting.



6. Liquids

When heating liquids, e.g. soup, sauces and beverages in your microwave oven, overheating the liquid beyond boiling point can occur without evidence of bubbling. This could result in a sudden boil over of the hot liquid. To prevent this possibility the following steps should be taken:



- Avoid using straight-sided container with narrow necks.
- Do not overheat.
- Stir the liquid before placing the containers in the oven and again halfway through the heating time.
- After heating, allow it to stand in the oven for a short time, stirring again before carefully removing the container.

7. Lids

Always remove the lids of jars and containers and take away food containers before you microwave them. If you don't, steam and pressure might build up inside and cause an explosion even after the microwave cooking has stopped.

8. Deep Fat Frying

Do not attempt to deep fat fry in your oven.

9. Temperature probe

Use a temperature probe to check the temperature of foods when they have been removed from the microwave. If undercooked, return to the oven and cook for a few more minutes at the recommended power level. Do not leave the temperature probe in the oven when microwaving.

10. Paper, Plastic

When heating food in plastic or paper containers, check the oven frequently as these types of containers ignite if overheated. Do not use wire twist-ties with roasting bags as arcing will occur. Do not use recycled paper products, e.g. kitchen roll unless they say they are specifically designed for use in a microwave oven. These products contain impurities which may cause sparks and/or fires when used.

Important Information — Read Carefully

11. Reheating

It is essential that reheated food is served "piping hot". Remove the food from the oven and check that it is "piping hot", i.e. steam is being emitted from all parts and any sauce is bubbling. If you wish you may choose to check the food has reached 72°C with a food thermometer – (but remember do not use this thermometer inside the microwave.) or to a temperature recommended by Government Food Hygiene Regulations.

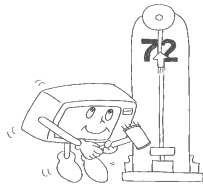

For foods that cannot be stirred, e.g. lasagne, shepherds pie, the centre should be cut with a knife to test it is well heated through. Even if a manufacturer's packet instructions have been followed, always check the food is piping hot before serving it. If in doubt return your food to the oven for further heating.

12. Standing Time

Standing time refers to the period at the end of cooking or reheating when food is left before being eaten, i.e. it is a rest time which allows the heat in the food to continue to conduct to the centre, thus eliminating cold spots.

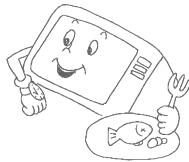

13. Keeping Your Oven Clean

It is essential for the safe operation of the oven that it is wiped out regularly. Use warm soapy water. Squeeze the cloth out well and use it to remove any grease or food from the interior. Pay particular attention to the door seal area and also the areas around the microwave feed guide situated on the right hand side of the cavity wall. The oven should be unplugged when cleaned.

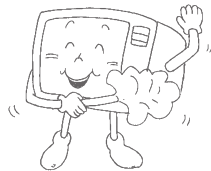

14. Babies Bottles and Food Jars

When reheating babies bottles always remove top and teat. Liquid at the top of the bottle will be much hotter than at the bottom and must be shaken thoroughly before checking the temperature. The lid must also be removed from babies food jars, the contents must also be stirred or shaken before the temperature is checked.

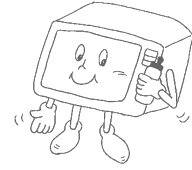

15. Containers

Before use check that utensils/containers are suitable for use in microwave ovens.

How Does the Microwave Work?

Microwaves are a form of high frequency radio waves similar to those used by a radio including AM, FM and CB. They are, however, much shorter than radio waves; approximately 12 cm long. Electricity is converted into microwave energy by the magnetron tube. From the magnetron tube, microwave energy is transmitted and absorbed.

Reflection

Microwaves are reflected by metal just as a ball is bounced off a wall. A combination of stationary (interior walls) and rotating antenna, located underneath the bottom shelf assure that the microwaves are well distributed within the oven cavity to produce even heating or cooking of foods.

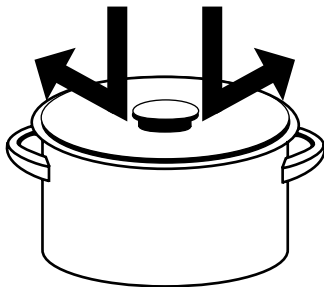

Transmission

Microwaves pass through some materials such as paper, glass and plastic much like sunlight shining through a window. Because these substances do not absorb or reflect the microwave energy, they are ideal materials for microwave oven heating containers.

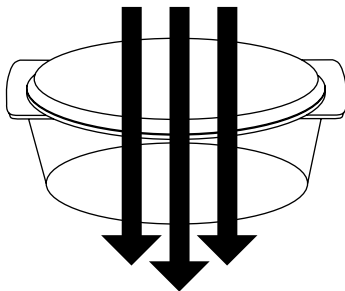

Absorption

During heating, microwaves will be absorbed by food. They penetrate to a depth of about 1- 5 cm. Microwave energy excites the molecules in the food (especially water, fat and sugar molecules), and causes them to vibrate at a rate of 2,450,000,000 times per second. This vibration causes friction, and heat is produced just as you will feel heat produced if you vigorously rub your hands together. The internal heating of larger foods is done by conduction. The heat which is produced by friction travels by conduction to the centre of the food. Foods also continue to heat by conduction during standing time.

Because microwaves dissipate, much like sunlight as it reaches the Earth's surface, they are not stored in food.

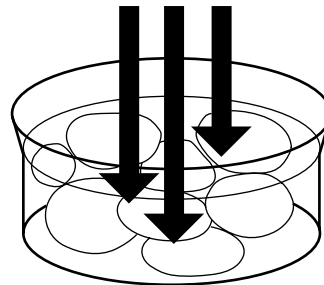

Radio Interference

1. Operation of the microwave oven may cause interference to your radio, TV or similar equipment.
2. When there is interference, it may be reduced or eliminated by taking the following measures:
 - a. Clean the door and sealed surfaces of the oven. (See Care of Your Microwave Oven found on page 19.)
 - b. Place the radio, TV, etc. as far away as possible, from the microwave.
 - c. Use a properly installed antenna, to obtain stronger signal reception.

Outline Diagram NE-1027

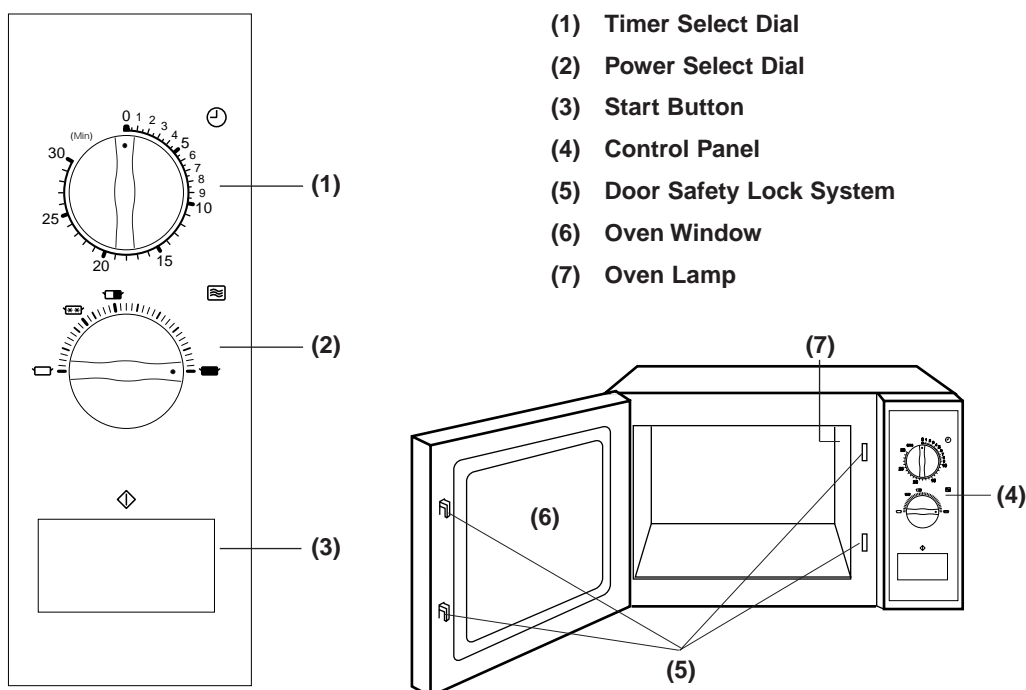





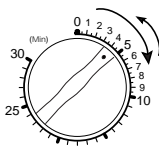
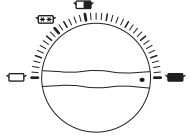

- (1) Timer Select Dial
- (2) Power Select Dial
- (3) Start Button
- (4) Control Panel
- (5) Door Safety Lock System
- (6) Oven Window
- (7) Oven Lamp

NE-1027

How to Operate

Heating

<p>1.</p> 	<ul style="list-style-type: none"> • Turn the Timer Select Dial to the desired position. <p>Note:</p> <ul style="list-style-type: none"> • When selecting the time for shorter than 4 minutes, turn the Timer Select Dial past 4 minutes and then return to the correct time.
<p>2.</p> 	<ul style="list-style-type: none"> • Turn the Power Select Dial to the desired power level. <p>Power Level:</p> <ul style="list-style-type: none">  ... 1000 W  ... 500 W  ... 340 W (Defrost)  ... 100 W
<p>3.</p> 	<ul style="list-style-type: none"> • Press the Start Button. <p>Heating will start.</p>

NOTE: • TO STOP THE OVEN, open the door or set the **Timer Select Dial** back to "0" (zero) position — microwaves will automatically stop.

- MEMO -

Outline Diagram NE-1037

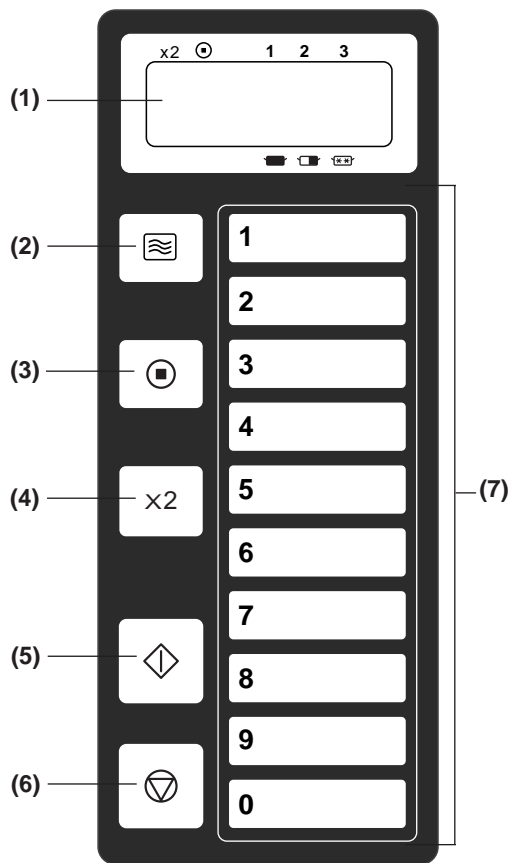

- (1) Digital Display Window (see below)
- (2) Power Level Pad
- (3) Program Pad
- (4) Double Quantity (x2) Pad
- (5) Start Pad
- (6) Stop/Reset Pad
- (7) Memory Pads
- (8) Control Panel
- (9) Door Safety Lock System
- (10) Oven Window
- (11) Oven Lamp

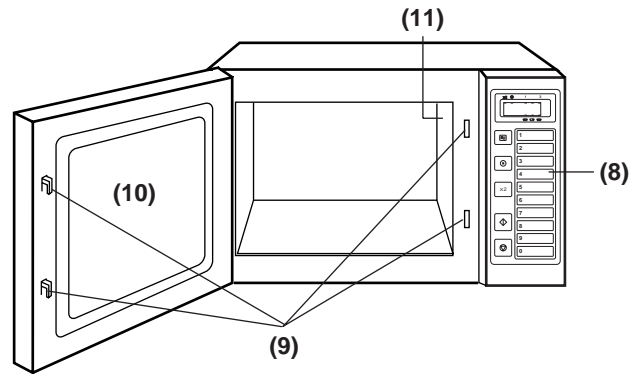

NE-1037

Digital Display Window Indicator Locations

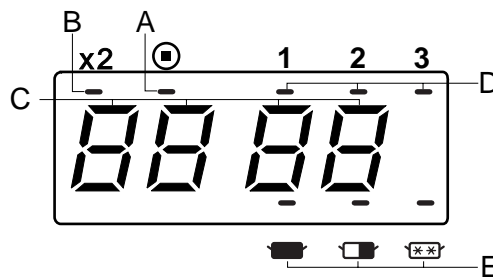

- A - Program Change Indicator
- B - Double Quantity (x2) Heating Indicator
- C - Memory Pad Number and Heating Time Display (min. sec.)
- D - Stage Heating Indicator

- E - Power Level Indicator
- 1000 W
- 500 W
- 340 W (Defrost)

How to Operate

Before Operating

Make sure the oven is connected to a properly earthed electrical outlet. When the door is closed, the display is still blank. When the door is opened, the display shows "0". For the detailed operation, see the page on each feature.

This oven is preset at the factory for the following:

1. Memory Pads preset to 1000 W at the indicated heating times for single stage heating.

Pad No.	1	2	3	4	5	6	7	8	9	0
Time	10 sec.	20 sec.	30 sec.	45 sec.	1 min.	1 min. 30 sec.	2 min.	2 min. 30 sec.	3 min.	3 min. 30 sec.

The Double Quantity Pad (x2) preset to automatically double the programmed time of each Memory Pad. (See pages 12, 15)

Example: Press  → = 2 min.

2. Program Unlock. (See page 16)
3. Cycle counter set to "0". (See page 18)

To set the power level:



Select power level before programming the cooking time.

Press



- once.....  1000 W
- twice.....  500 W
- 3 times...  340 W (Defrost)

To set the cooking time:

You can set up to 30 minutes for  and 99 minutes 99 seconds for  and .

Example 1: To set 15 minutes 45 seconds

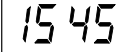
Press → → → 

Example 2: To set 85 minutes 30 seconds

Press → → → 

When you press the Start Pad, the display shows 1 hour 25 minutes instead of 85 minutes 30 seconds. When selected cooking time is over an hour, the display shows hours and minutes, but the oven works for your setting time.

↓

Display:

The display will go blank (when the door is closed):

- at more than 1 minute interruption.
- at more than 1 minute after completion of heating and removing food.

The display will flash "0":

- continuously if the door is not opened to remove the food.

Oven Light:

Oven light will be turned on, when:

- the door is opened.
- heating starts.

Oven light will be turned off, when:

- the door is closed (no heating).
- heating finishes.

How to Operate



Heating

Open the door and place the food in the oven cavity. Close the door.
"0" must be showing in the display window.

A. Manual Single Stage Heating:

This feature gives the user maximum flexibility to set the oven to desired heating time and power level. This is ideal for menus that require various heating requirements.

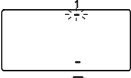
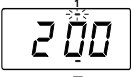
Example: To heat for 2 minutes at 1000 W

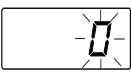
1. 	• Press the Power Level Pad once.	
2. <input type="text" value="2"/> <input type="text" value="0"/> <input type="text" value="0"/>	• Press the Memory Pads 2, 0 and 0 .	
3. 	• Press the Start Pad. Heating will start. The time on digital display will count down.	
4. Beep tone will sound. (See page 18)	• All heating will stop. When opening the door, the display will stop blinking.	

B. Manual 2 or 3 Stages Heating:



This feature allows you to set to begin heating at one power level then shift automatically to a different power level after the designated length of heating time.

Example: To heat for 2 minutes at 340 W for 2nd stage heating

For Stage 1 cooking

1.	• Follow steps 1 and 2 above table.	
----	-------------------------------------	--

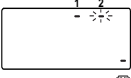
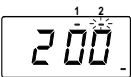
For Stage 2 cooking

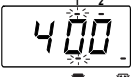
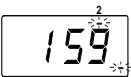
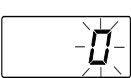
1. 	• Press the Power Level Pad 3 times. Indicator will change each time the pad is pressed. "3" is now displayed. The stage "2" is blinking.	
2. <input type="text" value="2"/> <input type="text" value="0"/> <input type="text" value="0"/>	• Press the Memory Pad 2, 0 and 0 .	
3. 	• Press the Start Pad. The total time for both stages will be displayed. The stage "1" and the power level "3" blink. The oven lamp will be turned on. Heating will start. • The total time will be displayed and count down. • When oven shifts to the next stage, a single beep tone will sound. The stage "2" and the power level "3" blink.	 
4. Beep tone will sound. (See page 18)	• All heating will stop. When opening the door, the display will stop blinking.	

NOTE:

For 3 stages heating, select a power level again and set the cooking time.

SPECIAL NOTE: For both single and 2 or 3 stages heating



1. While heating, one touch on the **Stop/Reset** Pad stops the oven. You can restart by pressing the **Start** Pad or a second touch on the **Stop/Reset** Pad will cancel the selected program.
2. One touch on the **Stop/Reset** Pad, before the heating cycle is started, will cancel the selected program.

NE-1037

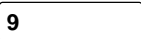
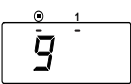

How to Operate

C: Programmed Heating:

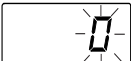
Example: 1 stage; Memory Pad 9 to heat for 3 minutes at 1000 W

1. 	<ul style="list-style-type: none"> Press the Memory Pad 9. In Program Lock Mode the oven will start without pressing the Start Pad. (See page 16) 	
2. 	<ul style="list-style-type: none"> Press the Start Pad. Heating will start. The time on digital display will count down. 	
3. Beep tone will sound. (See page 18)	<ul style="list-style-type: none"> All heating will stop. When opening the door, the display will stop blinking. 	

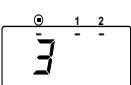

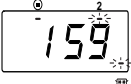
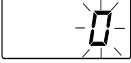

Example: 2 stages; Memory Pad 3 to heat for 3 minutes at 1000 W and 2 minutes at 340 W

1. 	<ul style="list-style-type: none"> Press the Memory Pad 3. In Program Lock Mode the oven will start without pressing the Start Pad. (See page 16) 	
2. 	<ul style="list-style-type: none"> Press the Start Pad. The total time for both stages will be displayed. The time on digital display will count down. Heating will start. When the oven shifts to the next stage, a single beep tone will sound. 	 
3. Beep tone will sound. (See page 18)	<ul style="list-style-type: none"> All heating will stop. When opening the door, the display will stop blinking. 	

For Double Quantity Heating:

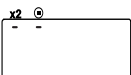
The Double Quantity (x2) Pad is preset at the factory to automatically double the programmed time for double quantity heating. (See page 15 for programming the Double Quantity Pad.)

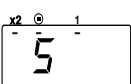
Example: Memory Pad 5

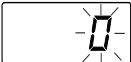
1. 	<ul style="list-style-type: none"> Press the Double Quantity Pad. 	
2. 	<ul style="list-style-type: none"> Press the Memory Pad 5. In Program Lock Mode oven will start without pressing the Start Pad. (See page 16) 	
3. 	<ul style="list-style-type: none"> Press the Start Pad. Heating will start. The time on digital display will count down. 	
4. Beep tone will sound. (See page 18)	<ul style="list-style-type: none"> All heating will stop. When opening the door, the display will stop blinking. 	

How to Operate







Programming

— DO NOT OPEN THE DOOR —

The display window MUST be blank before programming. If any indicator light is illuminated in the digital display window: close the door, press the **Stop/Reset** Pad and wait 1 minute until the display goes blank.

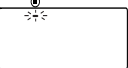
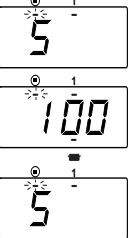
A. Programming Memory Pads for Single Stage Heating:

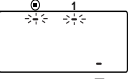
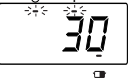
Example: To program 30 seconds at 500 W for Memory Pad 5

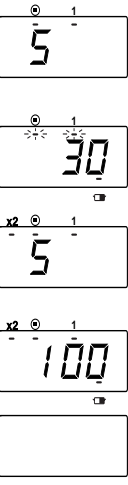
<p>1. </p>	<ul style="list-style-type: none"> Press the Program Pad. Note: <ul style="list-style-type: none"> If no “” Indicator appeared on display, “Program Lock” should be cancelled. (See page 16) 	
<p>2. <input type="text" value="5"/></p>	<ul style="list-style-type: none"> Press the Memory Pad 5. The pad number and the previously selected time and power level will appear in the display. The pad number and Stage Heating Indicator will appear in the display again. 	
<p>3. </p>	<ul style="list-style-type: none"> Press the Power Level Pad twice. The Memory Pad number will go out. 	
<p>4. <input type="text" value="3"/> <input type="text" value="0"/></p>	<ul style="list-style-type: none"> Press Memory Pads 3 and 0. 	
<p>5. </p>	<ul style="list-style-type: none"> Press the Program Pad again. You have completed programming the selected Memory Pad for single stage heating. Double heating time for double quantity heating was automatically set. 2 seconds later, the time and power level setting you programmed will appear in the display. 2 seconds later, Double Quantity Heating Indicator and then the double heating time will appear in the display. 2 seconds later, the display will go blank. <p>The Memory Pad 5 is now programmed for heating - 30 seconds at 500 W.</p>	

NOTE:







- Program the remaining Memory Pads as desired by repeating steps 1 - 5. You may insert up to 10 memory programs.
- When the Program indicator “” is blinking, the program can be cancelled and/or the pad number erased by pressing the **Stop/Reset** Pad.

NE-1037

How to Operate

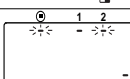
B. Programming Memory Pads for 2 or 3 Stages Heating:

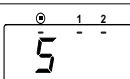
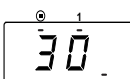
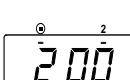
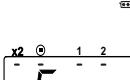
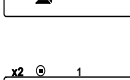
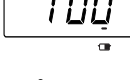
Example: To program for 2 minutes at 340 W for 2nd stage heating using Memory Pad 5

<p>1. Complete steps 1 to 4 on page 13.</p>	<ul style="list-style-type: none"> Program the 1st stage for 30 seconds at 500 W. 	
<p>2. </p>	<ul style="list-style-type: none"> Press the Power Level Pad 3 times. “” is now displayed. 	
<p>3. <input style="width: 40px; text-align: center;" type="text" value="2"/> <input style="width: 40px; text-align: center;" type="text" value="0"/> <input style="width: 40px; text-align: center;" type="text" value="0"/></p>	<ul style="list-style-type: none"> Press the Memory Pads 2, 0 and 0. 	
<p>4. </p>	<ul style="list-style-type: none"> Press the Program Pad again. You have completed programming the selected Memory Pad for 2 stages heating. Double heating time for double quantity heating was automatically set. 2 seconds later, the display will confirm your programming. 	     
	<ul style="list-style-type: none"> After all of your programming has been completed, the display will go blank. 	

NOTE:

- Program the remaining Memory Pads as desired by repeating the steps above.
- DO NOT OPEN THE OVEN DOOR** during programming.
- For 3 stages heating, select a further power level and set the desired heating time between steps 3 and 4 above.

NE-1037

How to Operate









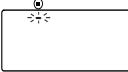

C. Programming the Double Quantity Pad:

Your oven is preset at the factory to automatically double the programmed time for double quantity heating.

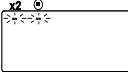
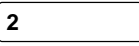
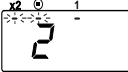
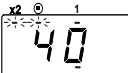
This model allows you to customize the heating time and/or power level for double quantity of your menu items.

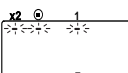
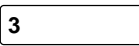
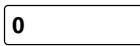
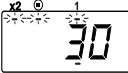
For example, if Memory Pad 2 is set for 20 seconds at 1000 W, 40 seconds at 1000 W is set for double quantity heating automatically. However, if your own tests have determined that the correct heating time required for two portions is less (only 30 seconds at 1000 W), you can program as shown below.

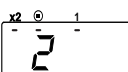
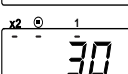
Example: To program 30 seconds at 1000 W on double quantity of Memory Pad 2 (display must be blank)

<p>1. </p>	<ul style="list-style-type: none"> Press the Program Pad. Note: <ul style="list-style-type: none"> If no “” Indicator appeared on display, “Program Lock” should be cancelled. (See page 16) 	
<p>2. </p>	<ul style="list-style-type: none"> Press Double Quantity Pad. 	
<p>3. </p>	<ul style="list-style-type: none"> Press the Memory Pad 2. The pad number and the previously selected time and power level for double quantity heating will briefly appear in the display. The pad number and Stage Heating Indicator will reappear in the display. 	  
<p>4. </p>	<ul style="list-style-type: none"> Press the Power Level Selector Pad once. The Memory Pad number will go out. 	
<p>5.  </p>	<ul style="list-style-type: none"> Press Memory Pads 3 and 0. 	
<p>6. </p>	<ul style="list-style-type: none"> Press the Program Pad again. You have completed programming the selected Memory Pad for double quantity heating. 2 seconds later, the display will confirm your programming. 2 seconds later, the display will go blank. 	  

NOTE:

- Program the remaining Memory Pads as desired by repeating steps 1 - 6 above. You may insert up to 10 memory programs.
- When the Program indicator “” is blinking, the program can be cancelled and/or the pad number erased by pressing the **Stop/Reset Pad**.



NE-1037

How to Operate

Other Features

A. To Activate Program Lock:

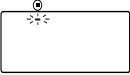
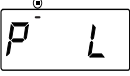

This procedure locks the Memory Pads into their programmed heating times and power levels.
DO NOT OPEN THE DOOR.

1. The display window must be blank.		
2. 	<ul style="list-style-type: none"> • Press and hold in the Program Pad (for 5 seconds) until the display shows "P" and "L". • Program Lock feature is now activated. 	 

- NOTE:**
- In "Program Lock"
 - a. To activate preset programs, open door will display "0".
 - b. The oven is started by pressing the desired Memory Pad. There is no need to press the **Start Pad**.
 - c. The interrupt feature is deactivated — Opening the door cancels the remaining time of the program.
 - d. The oven cannot be programmed until the Program Lock is released.

B. To Release Program Lock:

This procedure releases "Program Lock" and activates all other features. The Oven reverts to a 2 touch operating mode (Memory Pad plus **Start Pad**).
DO NOT OPEN THE DOOR.

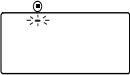
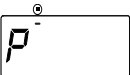
1. The display window must be blank.		
2.  + 	<ul style="list-style-type: none"> • Press the Stop/Reset Pad. While pressing this pad, press the Program Pad (for 5 seconds) until the display shows "P". • Program Lock feature is now released. 	 





- NOTE:**
- In "Program Unlock"
 - a. Repeat and interrupt features are operational.
 - b. Memory Pads can be programmed.
 - c. Beep Tone can be set On or Off.

NE-1037

How to Operate

C. To Read Program List:

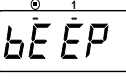
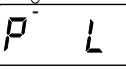
Allows you to review all currently programmed pad number, heating time and power level for each stage.

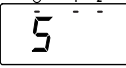
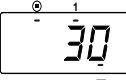
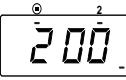
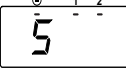
<p>1. Open the door.</p>		
<p>2.</p>  + 	<ul style="list-style-type: none"> While pressing the Stop/Reset Pad, press the Start Pad. The beep tone setting will be shown in the display window. Example: Stage Indicator 1: Beep tone is ON. Stage Indicator 2: Beep tone is OFF. 2 seconds later, the Program Lock setting will be shown in the display window. Program Lock: "P L" Program Unlock: "P" 	 
<p>3.</p> 	<ul style="list-style-type: none"> Press the Memory Pad you desire to read the program. Example: The Memory Pad 5. The display window will show; Program Memory Pad 5, first stage heating time and power level currently programmed on Memory Pad. 2 seconds later, the information of 2nd and 3rd stage heating will be displayed. After all settings have been displayed, the pad number and the Stage Heating Indicator will appear in the display again. 	   

NE-1037

- NOTE:**
- If you want to go to another program, press the Memory Pad you desire in order to read the program, while the information of Memory Pad is being displayed.
 - If you want to see the Double Quantity Heating (x2) program, press the **Double Quantity** Pad before pressing the Memory Pad.

How to Operate

D. To Select Beep Tone Options:

The Beep Tone can be set, ON or OFF.

1. Open the door.		
2.	<ul style="list-style-type: none"> Press the Program Pad. The display will not change. 	
3.	<ul style="list-style-type: none"> Press the Memory Pad 0. 	
4.	<ul style="list-style-type: none"> Repeat pressing the Memory Pad 0. Select "OFF" of Beep Tone. Stage Indicator 1 = ON Stage Indicator 2 = OFF 	
5.	<ul style="list-style-type: none"> Press the Program Pad again. You have completed programming the beep tone. 2 seconds later, "0" will appear in the display. 	

NE-1037

E. To Read the Cycle Counter:

The oven can display the total number of times the oven has been operated cumulatively. This may be used to analyze usage of the oven and traffic flow at the location.

1. Open the door.		
2. +	<ul style="list-style-type: none"> While pressing Stop/Reset Pad, press Power Level Pad. The display shows the total cumulative number of times the oven has been used. Example: <ul style="list-style-type: none"> 9999 means the oven has been used 999900 - 999999 times. 0020 means the oven has been used 2000 - 2099 times. If the total cumulative number of times is less than 100 times, the display will not be changed. 2 seconds later, "0" will appear in the display window. 	

Self Diagnostics Failure Code

This oven monitors its operation and displays a Failure Code in the display window when a problem occurs.

What to do when a failure code appears:

CODE	CAUSE	WHAT TO DO
F01	<ul style="list-style-type: none"> * Overcooked food * Temperature of exhausted air is too high 	<ul style="list-style-type: none"> * Press Stop/Reset Pad to stop beep. * Unplug the oven and wait at least 30 minutes before reconnecting. * Wait for the oven to cool down and reset. * If a flame is observed, do not open the oven door. * If normal operation does not resume, call the service agent with the information of failure code.
F33-34	<ul style="list-style-type: none"> * Defective sensor circuit 	<ul style="list-style-type: none"> * Unplug the oven and wait more than 10 seconds before reconnecting.
F44	<ul style="list-style-type: none"> * When a pad was pressed for more than 2 minutes * Defective pad or control circuit 	<ul style="list-style-type: none"> * If normal operation does not resume, call the service agent with the information of failure code.

NOTE: Above codes shown in the display do not indicate all the possible failures on the unit.

Care of Your Microwave Oven

1. Unplug the oven before cleaning.
2. Keep the inside of the oven clean. When food spatters or spilled liquids adhere to the oven walls, wipe with a damp paper towel. Mild detergent may be used if the oven gets very dirty. The use of harsh detergent or abrasives is not recommended.
3. The outside oven surfaces should be cleaned with a damp paper towel. To prevent damage to the operating parts inside the oven, water should not be allowed to seep into the ventilation openings.
4. If the Control Panel becomes dirty, clean it with a soft, dry cloth. Do not use harsh detergents or abrasives on the Control Panel. When cleaning the Control Panel, leave the oven door open to prevent the oven from accidentally turning on. After cleaning, press the **Stop/Reset** Pad to clear the display window or turn the **Timer Select Dial** back to zero "0" position.
5. If steam accumulates inside or around the outside of the oven door, wipe with a soft paper towel. This may occur when the microwave oven is operated under high humidity conditions and in no way indicates malfunction of the unit.
6. Clean off the grease and dust on bottom surfaces often. Use warm detergent solution.
7. This oven should only be serviced by qualified person. For maintenance and repair of the oven contact the nearest authorized dealer.

Cooking/Defrosting Guide

The times given in the chart below are a **guideline only**. Many factors eg **starting temperature** of the food can affect the final heating time required. The cooking and defrosting times must be adjusted when necessary.

All times are tested using foods at **starting temperatures** as below;

Chilled foodsApprox. +5°C











Frozen foodsApprox. -18°C

Always check for the correct core temperature with a temperature probe to comply with current Government Food Hygiene Regulations.

Function	Food	Weight	Power Level	Time
Defrosting	Fish Fillets	500 g (1 lb 2 oz)	340 W	8 min.
	Minced Beef	500 g (1 lb 2 oz)	340 W	5 min.
	Whole Chicken	1.36 kg (3 lb)	340 W	25 min.
	Composite Dish			
	Multi portion	1.36 kg (3 lb)	340 W	20 min.
	Single portion	275 g (10 oz)	340 W	8 min.
	Apple Pie	1 portion	340 W	1 min. 15 sec.
	Gateau	1 portion	340 W	2 min.
	Bread Rolls	1 portion 50 g (2 oz)	340 W	30 sec.
Cooking from Chilled Raw Food	Scrambled Egg	2 eggs + 2 tbsp. milk	1000 W	45 sec.
	Broccoli	500 g (1 lb 2 oz)	1000 W	6 min.
	Fish Fillets	500 g (1 lb 2 oz)	1000 W	4 min.
	Bacon	2 rashers	1000 W	1 min. 30 sec.
	Chicken Portions	500 g (1 lb 2 oz)	1000 W	5 min. 30 sec. - 6 min. 30 sec.
Cooking and/or Reheating from Frozen	Peas	500 g (1 lb 2 oz)	1000 W	8 min.
	Cooked Rice	167 g (6 1/2 oz)	1000 W	2 min. 20 sec. - 2 min. 45 sec.
	Cooked Sausages	x 3 (50 g/2 oz each)	1000 W	1 min. 20 sec. - 1 min. 45 sec.
	Cooked Wings of Fire	x 7 pieces	1000 W	2 min. - 2 min. 20 sec.
	Cooked Boxed Cheeseburger	75 g (3 oz)	1000 W	1 min. 30 sec. - 1 min. 45 sec.
	Chocolate Fudge Cake	1 portion	340 W	30 sec.
Reheating from Cooked Chilled	Lasagne	325 g (11 oz)	1000 W	3 min. 45 sec. - 4 min. 15 sec.
	Chilli	325 g (11 oz)	1000 W	3 min. 30 sec. - 4 min.
	Apple Pie	1 portion	1000 W	30 sec.
	Pepper Sauce	100 ml (4 fl oz)	1000 W	1 min. - 1 min. 15 sec.
	Baked Beans	100 ml (4 fl oz)	1000 W	1 min. 15 sec. - 1 min. 30 sec.
	Soup	125 ml (6 fl oz)	1000 W	1 min. 30 sec. - 1 min. 45 sec.

- HINTS:**
- Do not cook/reheat/defrost directly onto the base of the oven — use a suitable container.
 - When defrosting **multi portions** of foods, turn over and break apart halfway through defrost time to allow better penetration of microwave energy.
 - **Solid/dense foods** should not be cooked from frozen as they will be overcooked round the edges before the centre has reached the required temperature.
 - **Cover** dishes where appropriate during cooking/reheating. This will retain moisture and prevent splashing/spillages.
 - Loosen lids/pierce clingfilm before cooking/reheating covered foods.
 - **Stir** or **shake** foods halfway through cooking/defrosting time to distribute the heat evenly.
 - Allow a **Stand Time** before food temperature is checked and/or offered for consumption.

Technical Specifications

	NE-1027	NE-1037
Power Source	230 - 240 V, 50 Hz, single phase	
Required Power	6.6 A 1490 W	
Output	<ul style="list-style-type: none">  1000 W *  500 W  340 W  100 W 	<ul style="list-style-type: none">  1000 W *  500 W  340 W
Frequency	2450 MHz	
Outer Dimensions (W x D x H)	510 mm x 360 mm x 306 mm (20 ¹ / ₈ " x 14 ¹ / ₈ " x 12")	
Cavity Dimensions (W x D x H)	330 mm x 330 mm x 200 mm (13" x 13" x 7 ⁷ / ₈ ")	
Net Weight	17.8 kg	
Shipping Weight	19.5 kg	
Timer	30 min. (Dial)	30 min. for  99 min. 99 sec. for  and 
Memory	_____	10 Memory Pads with Double Quantity (X2) Pad

* IEC 705-88 Test Procedure

Specifications subject to change without notice.

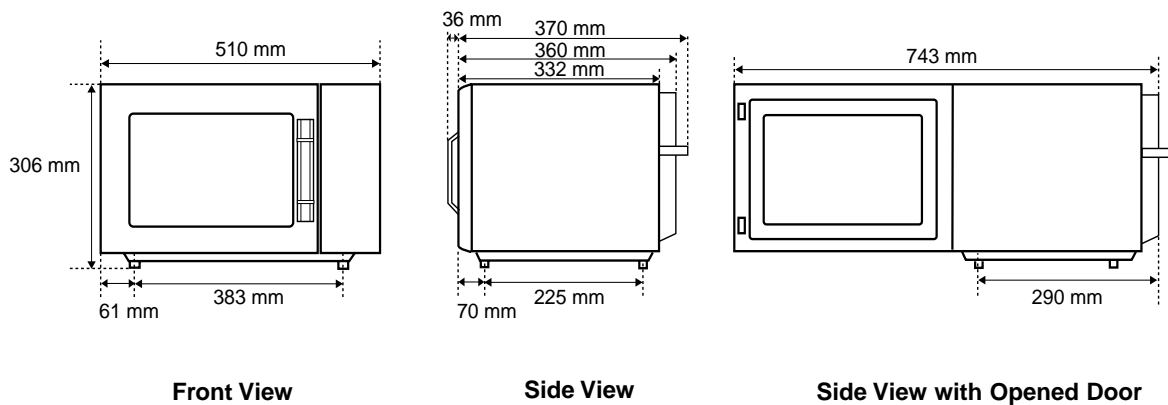

Matsushita Electric Industrial Co., Ltd.

Central P.O.Box 288, Osaka 530-91, Japan

A00033701BP
F0297-0
Printed in Japan