



Dive Xtras DPV User Manual

09/30/2022 (Version 1.5)

Models Covered: DX-004-1X000

General Description

This Dive Xtras DPV series is range of underwater tow behind diver propulsion vehicles designed to enhance a diver's underwater experience. This owner's manual is not a training manual and should not be substituted for a proper training course. It is the diver's personal responsibility to seek proper training in the use of their DPV and to dive within the limits of their training, experience and DPV as described in the specification.

Original Instructions



Contents

| | |
|-------------------------------|----|
| Cautions & Warnings..... | 3 |
| Specifications..... | 5 |
| Basic Scooter Components..... | 6 |
| Batteries..... | 7 |
| Assembly..... | 8 |
| Operation..... | 9 |
| Dive Planning..... | 11 |
| Scooter Failures..... | 11 |
| Post-Dive Procedures..... | 14 |
| Travel & Storage..... | 15 |
| Maintenance..... | 16 |
| Spare Parts..... | 17 |
| Troubleshooting..... | 17 |
| Compliance..... | 18 |
| Warranty & Returns..... | 20 |

Cautions & Warnings

Proper Training Required

Always seek proper DPV and dive training prior to using any DPV. Use of Dive Xtras DPVs assumes proper training. Dive Xtras will not be held liable for any injury or death while using this DPV.

Do not operate continuously outside of water

Dive Xtras DPVs are not designed for continuous surface operation. Operation for periods of time longer than 15-30 seconds outside of water may damage rotational seals and compromise sealing capability of the DPV.

Never ascend using your DPV to pull you towards the surface.

This will cause a rapid ascent as explained in basic diver training and should be avoided at all times. A rapid ascent can cause serious injuries such as, but not limited to, lung over-expansion injuries, decompression illness, rupture of the ear drum, and in extreme cases, even death.

Never allow the DPV to put you at risk.

If at any time during your diving activity with a DPV you feel you are at risk, immediately unclip the DPV tow cord and release the DPV.

Placing your hands in the way of the propeller blades can cause damage and/or injury.

Inadvertently getting your hands or other objects caught in the spinning propeller blades can cause damage to your DPV as well as to you. The Dive Xtras DPVs have built in safety features to minimize this danger, but damage/injury may still occur.



Be careful not to entangle hair, equipment, line and/or seaweed, etc. in the propeller.

This may cause the DPV propeller to slow or even stop. Ensure you stop, releasing the trigger, and untangle whatever has caused the entanglement.

DPV may flood if improperly sealed.

Always follow the procedure outlined in the manual for installing batteries and sealing the DPV. If flooding does occur, follow process outlined in the “Flood Recovery” section of the manual.

DPV failure may cause a runaway scooter.

Follow the procedure outlined in the “DPV Won’t Stop Running” section of the manual in the event of a runaway scooter.

Always ensure to connect like colors, whenever connecting any electric connectors.

Always connect red to red, black to black and blue to blue. Failure to do so will result in damage to your DPV or batteries.

Always ensure correct operation of the on/off trigger prior to use.

Always ensure you check the trigger action prior to use of the DPV to ensure correct operation.

(Continued)

A DPV is considered a heavy object.

Use caution when lifting. Always use safe lifting practices when lifting your DPV and utilize built-in handles. Bend from your knees keeping your back straight.

When transporting your DPV on a boat, car or airplane, always ensure your DPV is safe and restrained from movement.

Your DPV is a heavy object, always safely restrain your DPV when transporting to avoid damage to your DPV or bystanders.

Always check the strap is fastened correctly and nothing has been pinched in the seals between the nose and battery tube and between the battery tube and tail.

When assembling your DPV, it is important to ensure that nothing is caught in the seals and none of the O-rings are protruding to minimize the risk of flooding.

Your DPV is not a toy, nor a suitable rescue tool.

It is for assistance in propulsion only. Do not rely on the DPV for ascent or assistance in an emergency.

Not for use by children.

DPV use and operation is not an activity suitable for children.

Remove batteries while not in use.

Batteries may sustain damage from prolonged installation while not in use. Battery removal also minimizes risk of inadvertent operation.

Sound Levels: A-weighted emission sound pressure level does not exceed 70 dB(A) during operation.

Vibration Levels: Hand-arm system vibration does not exceed 2.5 m/s^2 during operation.

Specifications

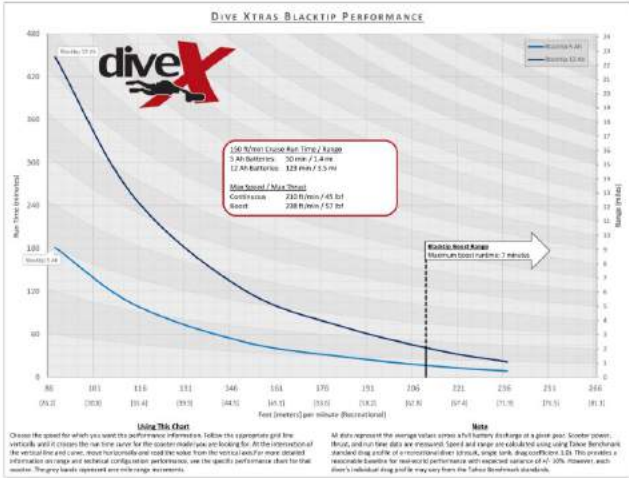

BlackTip Travel

- Weight:** 24lbs (10.9kg)
- Length:** 24in (61cm)
- Depth Rating:** 330ft (100 meters)
- Continuous Max Speed:** 210ft/min (64m/min)
- Boost Mode Max Speed:** 230ft/min (73m/min)
- Boost Mode Max Runtime:** 7 minutes
- Boost Mode Max Thrust:** 57lbs (253N)

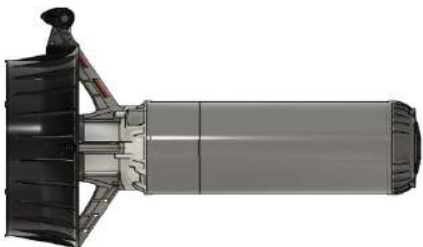

BlackTip Tech

- Weight:** 28.5lbs (12.9kg)
- Length:** 28.5in (72.3cm)
- Depth Rating:** 400ft (121.9 meters)
- Continuous Max Speed:** 210ft/min (64m/min)
- Boost Mode Max Speed:** 230ft/min (73m/min)
- Boost Mode Max Runtime:** 7 minutes
- Boost Mode Max Thrust:** 57lbs (253N)

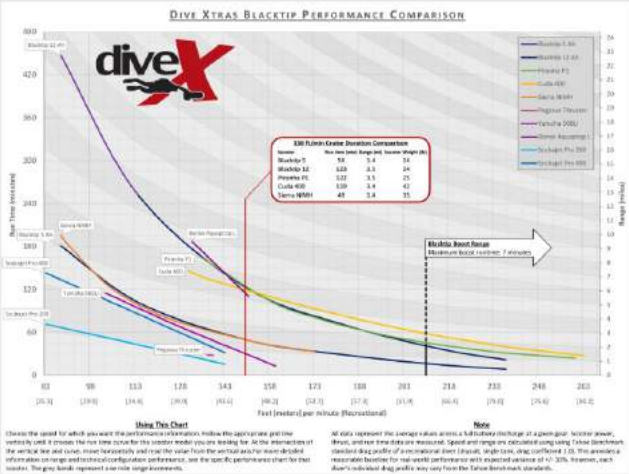

BlackTip Exploration

- Weight:** 37lbs (16.7kg)
- Length:** 37in (94cm)
- Depth Rating:** 260ft (80 meters)
- Continuous Max Speed:** 210ft/min (64m/min)
- Boost Mode Max Speed:** 230ft/min (73m/min)
- Boost Mode Max Runtime:** 7 minutes
- Boost Mode Max Thrust:** 57lbs (253N)

Basic Scooter Components

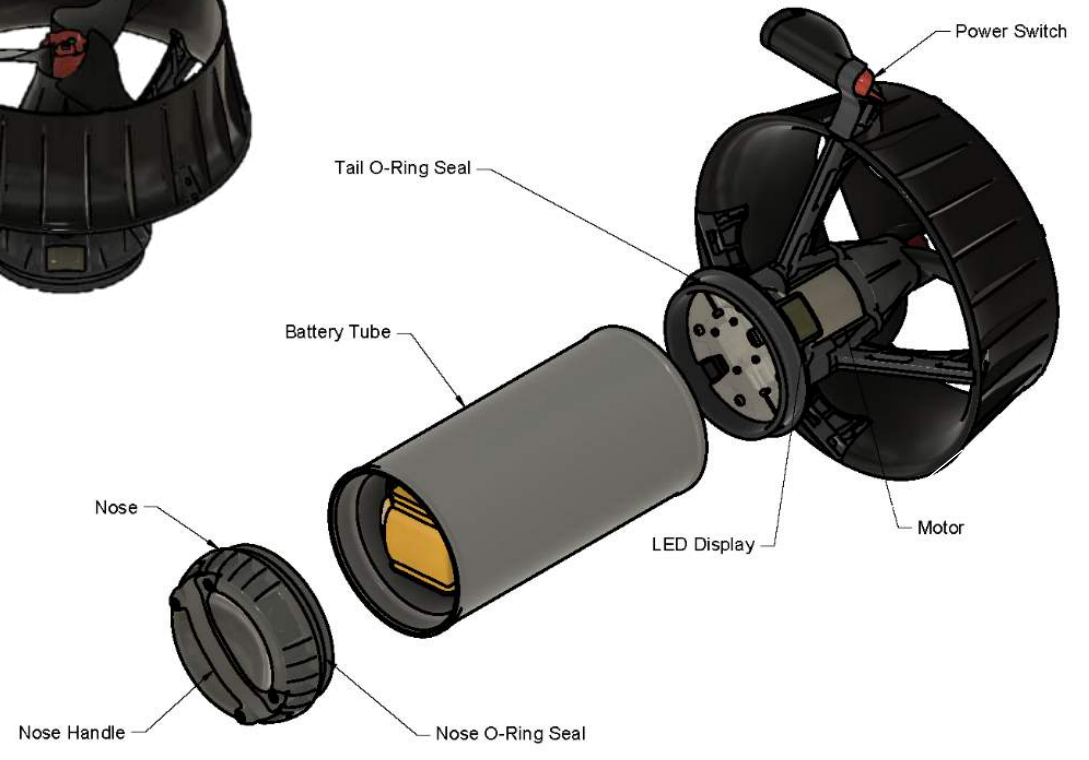
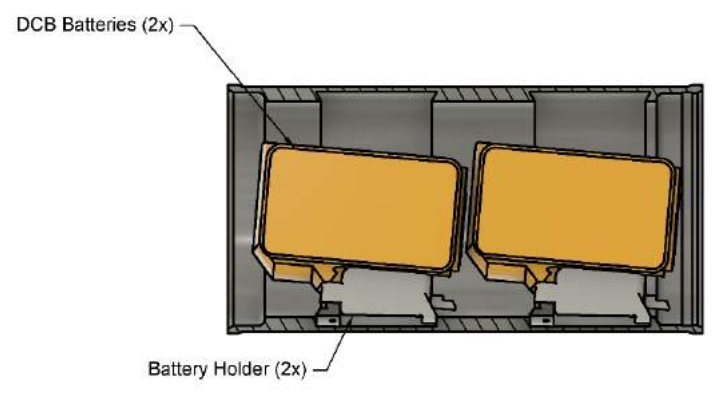
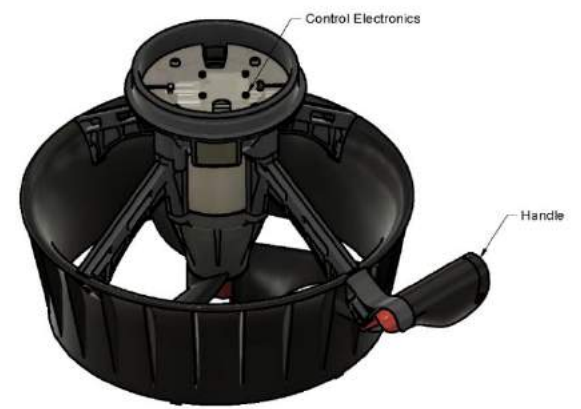
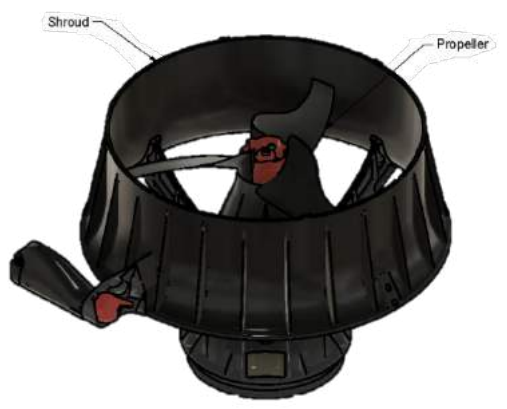
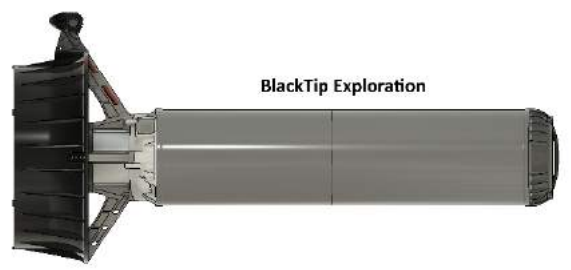
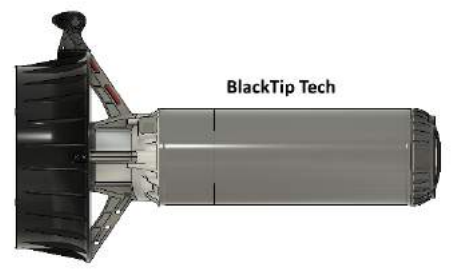

Batteries

Which Batteries to Use?

The DPV accepts any DCB-type power tool batteries. In the USA, these are commonly called 20v Max, whereas in Europe they are known as 18v XR. Supported amp hours are 5Ah, 6Ah, 9Ah, and 12Ah battery capacities. Note that both batteries should be the same age and capacity. For optimal performance, do not mix battery capacities or ages in your DPV. Name brand batteries are not required. Here in the US, we purchase our batteries and chargers online via Amazon or other retailers. You will also need to purchase a compatible charger for your batteries.



Charging Your Batteries

Always fully charge both batteries before installing them in your DPV. This will help prevent your DPV from receiving different voltage readings from each battery and will keep your BlackTip running smoothly. Try to charge your batteries close to your dive time, and never store your batteries inside your scooter, the small power draw of the scooter will eventually drain the batteries and potentially damage them.

Scooter Battery Info

Runtime and range will vary, depending on your choice of batteries. See below for specs on different battery options. (Batteries and charger not included with purchase of scooter)

| | BlackTip w/ 5Ah Battery | BlackTip w/ 12Ah Battery |
|---------------------------------------------------|-------------------------|--------------------------|
| Runtime at Cruise Speed (150 ft/min; 45 m/min) | 50 minutes | 123 minutes |
| Range at Cruise Speed (150 ft/min; 45 m/min) | 1.4 miles (2.3km) | 3.5 miles (5.6km) |

Compatible with 5Ah, 6Ah, 9Ah, 12Ah, 20v (USA only) or 18v batteries that fit the DCB interface.

Assembly

Installing Your Batteries

To install your batteries into the DPV, first loosen the strap securing the cylinder and remove the nose cone off the front of the scooter. Then insert your batteries one at a time into the two battery clips located along the length of the scooter interior. Replace the nose cone by pressing firmly on all sides until it locks into place, then finish the installation by securing the strap over the top of the scooter. Try to install your batteries close to your dive time, and never store your batteries inside your scooter, the small power draw of the scooter will eventually drain the batteries and potentially damage them.

Using the Tow-Cord Attachment

It's very important to use the tow cord while operating your DPV, as the scooter is designed to only be used in conjunction with one. The tow-cord carries all the thrust of the scooter, allowing you to concentrate on steering and other activities. Simply adjust the sliding knot on the long end of your tow cord rope to match the length of your reach, then fasten it to your gear. The tow-cord typically attaches to a D-ring secured to the crotch area of your equipment. Some dive equipment has this attachment point built-in, in the form of a crotch strap. If your diving gear does not feature this attachment point, make sure you obtain one before operating your scooter. You can find one listed on our website or consider buying and using a climbing harness, similar to the one pictured below.



1. Assembly

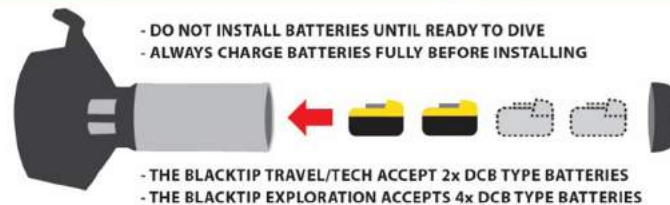

2. Strap

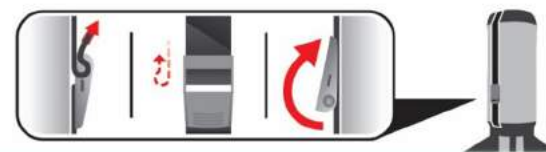

Operation

Operating Your DPV

You'll control your DPV by using double and single clicks on the thumb trigger. Once you're in the water, double-clicking the trigger will start the DPV at speed 3, known as cruise speed. To increase speed, double-click again -once for each speed gear increase. Single-clicking will decrease your speed by one gear with each click. To stop your scooter, simply let go of the thumb trigger.



Safe Start

When you first start the DPV, it will spin its prop slowly at low power before shifting to cruise speed. This is called "safe start". The DPV will not allow you to engage any speed gears until it has confirmed that nothing is obstructing the prop. This is to help prevent accidents. Once running in the water, safe start is only active again if the scooter is at speed 3. If you are in a higher or lower gear, safe start is disabled, allowing you to restart the scooter more quickly. With the DPV's migrate feature, the scooter always returns to speed 3, so a scooter left alone for a short time will always activate in safe start mode.



Buoyancy & Trim

Your DPV's buoyancy can be adjusted to suit your diving. It can be made neutral however it will always float nose up and there is no real way to correct this.

Weight can be added or removed from the nose of the scooter. There are pockets in the nose that can be filled with lead shot from an old soft weight or similar. To access the pockets, remove the 4 screws on the back of the nose cap and lift off the thin stainless-steel cover plate. The scooter ships from the factory with a larger, additional steel plate in the nose, and you can choose to leave this or remove it.

Do not try to remove weight from the tail. There is no weight adjustment in the tail, or any removable parts.

We recommend adjusting your buoyancy so the scooter will float trim while the handle is held. This way it is easy to use when scootering, and only floats nose up when you stow it.



Speed Modes

Out of the box, the DPV comes loaded with 8 speed modes. Double-click to speed up, single click to slow down. Every time you change gear, the LED display will indicate the current gear.

(Continued)

Boost Mode

At the higher speeds such as gear 7 and 8, the current draw is quite high and running at these speeds continuously would overheat the motor or electronics. To prevent this happening, the scooter will start to throttle back its output after a period of time. In speed 8, this time is typically 7 minutes. In speed 7 however, it is much longer. Releasing the trigger for an extended amount of time will allow the scooter to cool itself, and the boost mode time limitation will extend for another 7 min. If you only use speed 8 for less than 7 minutes, you may never even notice it's there! Staying on the trigger in speed 8 continuously will cause the scooter to eventually slow down to somewhere between speed 6 or 7. But for most users, this cap will probably be undetectable, as 7 minutes at speed 8 is quite a lot of scootering!

Speed Migrate

If you release the trigger for a brief moment, your DPV will restart in the same speed as you stopped. If you wait a longer period, the speed at which your scooter restarts will change, migrating slowly back to the start speed. For every five seconds your scooter has been stopped, the DPV will automatically shift one gear closer to its default speed of 3. This works both ways, whether the DPV is traveling faster or slower than speed 3. If the DPV has been stopped for less than five seconds, it will restart at the same speed as before.

Battery Status

The BlackTip LED screen will display battery status bars when motor operation is paused, usually preceded by a short loading screen. If the battery is dead, a small "1" or "2" may appear in the corner of the screen as well, to show which battery may have been exhausted first. See the chart below for an illustrated breakdown of each battery level and status.

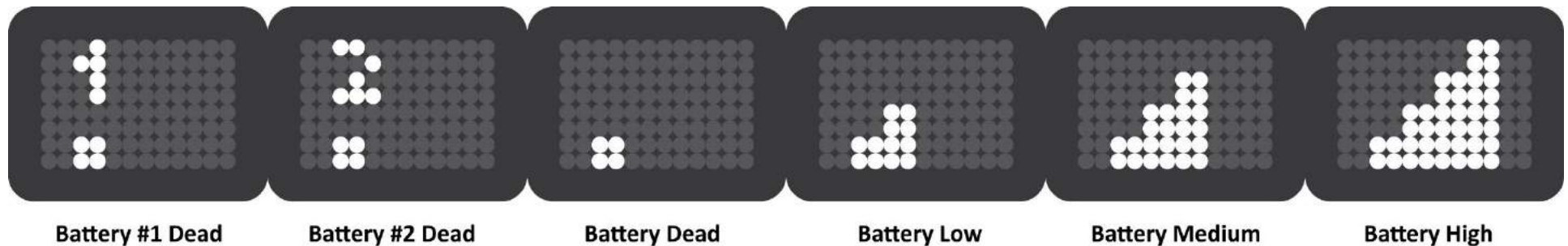

Dive Planning

Your DPV travels much faster than normal swimming speeds. If the user is diving in a buddy pair, they should be more vigilant of their buddy to avoid losing track of them at the increased speeds. These speeds may also increase the risk of collisions with objects and/or other divers especially in limited visibility situations. Always pay close attention to your buddy, where you are traveling, and to your speed to reduce the risk of these incidents occurring.

Distance & Runtime

Your DPV is capable of traveling great distances. Therefore, if it is required that you have to return to the same point as you started the dive (the exit), and swimming out or ascending to the surface is not an option, then one should pay close attention to run times of their DPV. Users should empirically calculate their max runtimes from actual dives and plan accordingly using adequate safety margins.

Scooter Failures

Dive Xtras DPVs are extremely reliable; however, divers should always be prepared to deal with failures.

Flooding

If the DPV floods on the dive, it may become significantly negative and become a risk to the user. The best option is to unclip the DPV via the tow cord bolt snap and release it. This will eliminate the risk and you can safely exit.

Flood Recovery

Occasionally things go badly. Floods typically happen in two ways:

- 1) **Minor flood.** DPV probably still works, and usually isn't detected until you get back to your car, boat, etc.
 - a. Follow the below points A-D on the next page.
- 2) **Bad flood.** The DPV is heavy and may be smoking, fizzing, or hot if the batteries are damaged.
 - a. Don't panic. Address the batteries first. If you see any fizzing, smoke, or heat, simply submerge the entire DPV underwater and remove the nose to flood the batteries. This will remove the heat and allow them to discharge safely. After the batteries have cooled down (this may take a few hours), follow instruction D below.

(Continued)

Instructions A-D:

- a) **A tiny amount of water (just a few drops), the DPV still works.**

- a. Wipe them out and try to be more careful opening the DPV and dripping water in from the nose or your dry/wetsuit. Store the scooter somewhere warm and dry to completely dry out.
- b) A small amount of water (a few tablespoons), the DPV still works.**
 - a. Remove the batteries and rinse the body section in fresh water. Invert tail to drain and dry. Dry everything thoroughly. You have a leak and need to identify what could have caused it. Look for pinched O-rings. Dirt, seaweed, etc.
- c) Lots of water, the DPV still works.**
 - a. Remove the batteries and rinse the whole DPV, inside and out, with fresh water. Dry everything thoroughly. You have a leak and need to identify what could have caused it. Look for pinched O-rings. Dirt, seaweed, etc. If the scooter still works after drying it is most likely fine, however, the batteries are most likely damaged. If you attempt to reuse the batteries, do so with caution. Charge in a safe, nonflammable space under careful observation.
- d) Lots of water, the DPV doesn't work.**
 - a. Remove the batteries and rinse the whole DPV, inside and out in fresh water. Dry everything thoroughly. Batteries will be damaged, recycle appropriately, Contact Dive Xtras for help with repairing your scooter.

DPV No Longer Runs

If your DPV were to fail and stop running during the dive, you have several options:

- 1) Swim the DPV**
 - a. If the DPV is not flooded you can simply stow the DPV by clipping it onto your person (in a low drag area if possible, such as a chest D-ring) and then swimming it back.
- 2) Getting a tow from your buddy**
 - a. If the DPV is not flooded, your buddy can tow you and your failed scooter. The DPV is capable of propelling two people, but for shorter distances and speeds.
- 3) Release the DPV**
 - a. If the above techniques are unsuitable or increase risk to the user, the best option is to unclip the DPV via the tow cord bolt snap and release it.

(Continued)

DPV Won't Stop Running

A runaway DPV can be hazardous as it is a powerful vehicle. If improperly managed, a continuously running DPV might initiate an uncontrolled ascent or descent. It is important to reduce the possibility of a runaway scooter by properly maintaining your DPV and following the various procedures outlined in the operating instructions. If your DPV were to fail during the dive, you have several options:

1) Lever Off the Trigger

- a. In the event of a runaway DPV, the trigger may be stuck in the 'On' position. Use your thumb to apply an opposing force on the trigger to lever it into the 'Off' position.

2) Grabbing the Propeller

- a. The DPV is equipped with a Safe Start system that allows you to simply grab the propeller without suffering injury. This will stop the propeller, allowing you to gain control of the scooter.

3) Reduce Thrust

- a. By pulling the propeller assembly into the diver's body restricting inlet flow you can reduce the overall thrust low level allowing you to gain control of the DPV.

4) Release the DPV

- a. If the above techniques are unsuitable or increase risk to the user, the best option is to unclip the DPV via the tow cord bolt snap and release it.

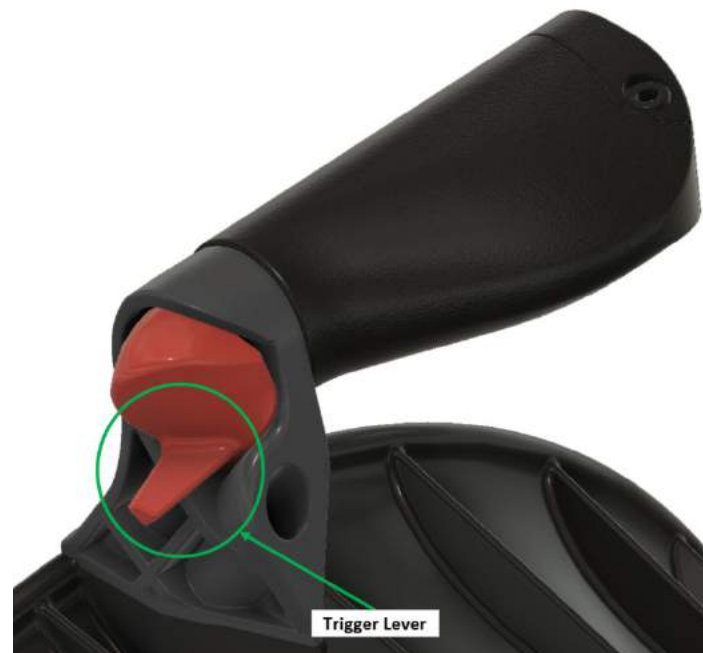

Post-Dive Procedures

After diving with your DPV, rinse the scooter clean, then run the DPV for a few seconds while pressing the trigger a few times to release any additional water buildup. After that, wipe or use compressed air to spray the scooter dry and remove the batteries, being careful not to allow drips or seepage into the scooter body and battery ports. It's important to do this as soon as possible after diving, and never store your batteries in your scooter. The small power draw of the scooter will eventually drain the batteries and potentially damage them. Store your scooter in a warm, dry location.

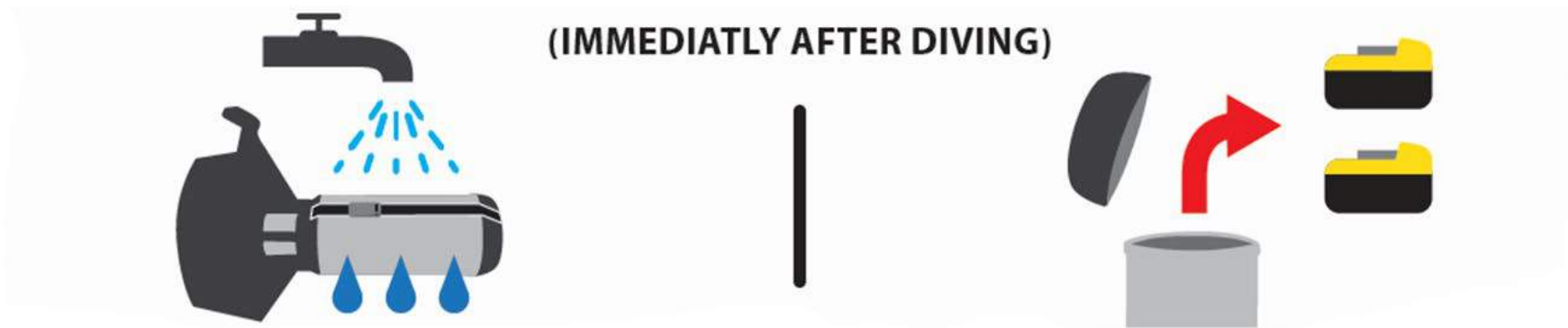

Travel & Storage

The easiest way to pack your DPV for travel is by separating the cylinder body from the tail. After removing the nose cone, pull firmly on the cylinder to detach it. One tip is to pull the body at an angle to more easily break the connection. After separating the cylinder from the tail, carefully disconnect the three wire connections before doing anything else.

Now that you've gotten your DPV disassembled, it can be packed for travel! Make sure to protect the tail unit and propeller area from damage, and the body can be stored with the nose cone either on or off. We recommend storing your BlackTip in a checked bag, as carry-on size and weight restrictions can vary airline to airline.

Your power tool batteries are also safe for travel! While the TSA does not allow loose lithium batteries in checked baggage, they can be safely stored in your carry-on bags by following these protocols. First, make sure your battery ports are protected from contact with other conductive materials, as this can cause a short and create a fire hazard. This can be done by covering each of the battery terminals with tape, sealing your batteries in a plastic bag, or simply leaving the batteries in their original packaging. Secondly, if you plan on traveling with larger capacity batteries like the FlexVolt, make sure to attach the batteries' included travel clip to keep the battery cells separated during travel.

Finally, even after following all these guidelines, the final decision will always come down to the TSA agents and the airline you'll be traveling with. We recommend checking your airline's battery and carry-on policies before you travel and taking every precaution when packing your scooter. Safe travels!



Maintenance

Battery Removal

Remove batteries from the DPV prior to any maintenance activity.

Shroud Removal

It is not necessary to remove the propeller shroud for any routine maintenance. The shroud is only to be removed by Dive Xtras maintenance personnel during a DPV overhaul.

O-Rings

The most important step in your DPV's maintenance is cleaning and maintaining your O-rings. Start by disassembling your DPV into its three main components: the nose cone, the body cylinder, and the tail unit. Then remove both O-ring pairs around the base of the nose cone and around the tail. Clean each O-ring with a clean cloth or paper towel, and wipe around each O-rings' groove. Then apply a light coating of silicone gel to the two innermost O-rings. This helps to preserve their sealing ability and lengthen their lifespan. If you notice any cracking or splitting on your O-rings, you'll need to replace them before diving again.

Propeller

For propeller maintenance, first inspect your DPV's blades for obvious damage. It's common for the leading edges to show signs of wear over time, so look for any damage beyond just nicks and scratches. Next, check the rotation of the prop, making sure it rotates smoothly and does not rub against the prop shroud at all. *(This is usually only a concern if the propeller or shroud has been dropped or damaged, but it's still recommended to check periodically.)* Lastly, although our swept-design propellers are highly effective at shedding foreign objects, there is still a small possibility that your prop may have become entangled. Clear out any kelp or fishing line from around the propeller. If you need to remove the prop, simply remove the large screw in the center of the prop base and reattach once cleaning is complete.

Thumb Trigger

Finally, you'll want to test your thumb trigger. Check for ease of movement. If your thumb trigger is hard to press or doesn't spring up easily, check the spaces around the thumb trigger for debris or blockage. You can usually clear out any foreign material with some compressed air or water into the grooves. If this doesn't work, try disassembling the trigger itself by carefully removing the small star-bit screw attached to the thumb trigger.

After you've completed all these steps, simply reassemble your DPV and store it in a warm, dry location. Remember to remove your batteries from your scooter before storing it.



Spare Parts

Dive Xtras recommends all users carry a basic spares kit. Minimum spares kit should contain: O-Rings, Fuse, and Prop Blade(s). Spare parts are available on the Dive Xtras website including O-Rings, Fuses, Propeller Blades, Noses, and more. Additional spare parts not listed on our website may be procured by contacting customer service at info@dive-xtras.com. Replaced parts may be returned to Dive Xtras for disposal at the cost of the customer or an appropriate local disposal option may be used. Any components replaced during a factory repair will be handled appropriately by the company.

Troubleshooting

If your DPV's LED displays a battery error, chances are you've encountered a battery mismatch. This is most likely caused by one battery not being as fully charged as the other. Your DPV will display either a number "1" or "2" to indicate which battery is performing improperly. "1" is for the top battery (closest to the nose), and "2" is for the bottom battery (closest to the tail). Make sure both batteries are fully charged, then try operating your DPV again. If the problem persists, it may be an issue with your battery outputting irregularly, and you may need to replace the battery itself.



CE Approval

All Dive Xtras DPV model numbers DX-004-1X000 are marked for diving to 80m and demonstrate conformity to the European Machinery Directive 2006/42/EC and EMC Directive 2014/30/EU.



RoHS Statement (Restriction of Hazardous Substances)

All Dive Xtras DPV model numbers DX-004-1X000 and all homogenous subcomponents wherein are, to the best of our knowledge, compliant with the requirements of Directive (EU)2015/863 of the European Parliament issued March 31,2015, (as amended) on the restriction of the use of certain hazardous substances in electrical and electronic equipment



WEEE Compliance (Waste Electrical and Electronic Equipment)

On July 4, 2012 the European Parliament and the Council of the European Union authorized Directive 2012/19/EU or WEEE (Waste Electrical and Electronic Equipment). The aim of the directive is to halt the growing volume of electrical and electronic equipment (EEE) waste disposed of in landfill sites. Dive Xtras Inc. has evaluated its product lines against the criteria set forth in the WEEE directive. As required by the legislation, any Dive Xtras product covered by the directive and sold in the EU after March 1, 2020 is marked with the Wheeled Bin symbol, inserted in the owner's manual or on the packaging. Dive Xtras Inc. uses the symbol based on EN 50419:2006 CENEL-EC standard.



Disposal of Electrical and Electronic Waste

At the end of the product's life, customers should return their electrical and electronic waste in Dive Xtras Inc. products back to the appropriate company. The appropriate company where it can be recycled and treated appropriately will be marked on the label. Alternatively, a local disposal option may be used if appropriate. Any EEE replaced during a factory repair will be handled appropriately by the company.

Issue 2 June 2020

Version 1.2

The supplier (responsible person):

Dive Xtras Inc., 11520 Airport Road, Everett, WA, USA

Declares that the products described:

Battery powered Diver Propulsion Vehicle (DPV)

Model/Serial Number:

BlackTip DPV
DX-004-1X000

Conforms to the following Directives

2006/42/EC, 2014/30/EU, EU 2015/863

Uses the following standards:

EN 60204-1:2016 , EN 61000-6-1:2007, EN 61000-6-3:2007, ISO 12100:2010

and complies with the relevant essential health and safety requirements of the Machinery Directive, on the approximation of the laws of the Member States relating to the safety of machinery, as well as the requirements regarding the use of hazardous substances in electrical and electronic equipment included in the RoHS directive, and the relevant EU harmonization legislation regarding the EMC directive.

The technical file is authorized to be compiled by Dive Xtras. Contact Dive Xtras at info@dive-xtras.com or +1 (425) 296-6570 to receive a digital version of the technical file.



Warranty & Returns

Standard Warranty

Dive Xtras provides a limited warranty to the original purchaser against all defects in original workmanship and material under normal use and service as outlined in the owner's manual for one year from the date of purchase, with the following exceptions:

1. Any flood or damage, for any reason, that is caused from flooding an O-ring-sealed or watertight area will not be covered under warranty. All O-ring-sealed products undergo extensive factory pressure testing before being shipped and delivered and are therefore guaranteed to be sealed and functioning when shipped from factory.
2. All batteries and chargers are warranted by Rabbit Tool Inc., Deep Sea Supply, AllCell Technologies, or the original battery/charger manufacturer. Dive Xtras is not responsible for any issues arising from the use or misuse of batteries and/or chargers.
3. Dive Xtras will not be liable for any loss, damages, or expenses including incidental or consequential damages directly or indirectly arising from the sale or use of this product.
4. All paint finishing, powder coating, or material stitching that is chipped, damaged, or unthreaded through customer use is not covered under warranty.
5. Dive Xtras does not warranty any product for aesthetic finishes. Issues with surface finish that do not affect function of the product are not covered under warranty.
6. Custom modifications to VESC components will void the warranty for those affected parts.
7. A 6-month warranty on all electronics.

What Does This Warranty Not Cover?

This limited warranty does not cover any damage due to: (a) transportation; (b) storage; (c) improper use; (d) failure to follow the product instructions or to perform any preventive maintenance; (e) modifications; (f) unauthorized repair; (g) normal wear and tear; or (h) external causes such as accidents, abuse, or other actions or events beyond our reasonable control.

Should your DPV prove to be defective within the terms of this warranty, it will be repaired or replaced (at Dive Xtras' discretion) free of charge with the exclusion of shipping and handling charges. Dive Xtras will not be responsible for any shipping charges to or from Dive Xtras, Inc.

Return & Replacement Policy

MERCHANDISE SHOULD NOT BE RETURNED WITHOUT AUTHORIZATION.

A Return Material Authorization (RMA) number from our Customer Service department must be obtained before returning goods. Items returned without an RMA number will be subject to inventory charges and fully inspected.

All returns will undergo evaluation. Dive Xtras reserves the right to determine if work falls under warranty. If we determine your return is not covered under warranty, we will contact you regarding any repair charges. All shipping charges, along with non-warranty repair work, are paid for by the equipment's owner.

Returned merchandise will be repaired or replaced at Dive Xtras' discretion.

Unauthorized returns or refused shipments of sellable merchandise will be subject to a 15% restocking fee.

Orders of customized product (custom logo merchandise) are generally not returnable. If an RMA is issued for a customized product, the order is subject to a 40-60% restocking fee, depending on the product.

All items must be freight prepaid.



Dive Xtras, Inc.

info@dive-xtras.com

+1 (425) 296-6570

11520 Airport Road

Everett, WA 98204