

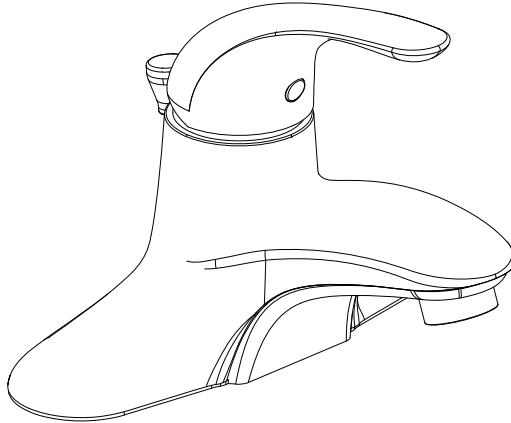

ALLORAUSA

INSTALLATION GUIDE



**Single Handle 4" Centerset Bathroom Faucet
B-4000**

TOOLS YOU WILL NEED



Adjustable Wrench



Pipe Tape



Phillips Screwdriver



Silicone Sealant

INSTALLATION TIPS

- Allora USA suggests using a locally licensed plumber for installation.
- Check if all the parts are present before beginning the installation.
- Cover your drain during the installation to avoid losing parts.

1 Turn water off.



HOT COLD

2 Remove locking nuts(7).

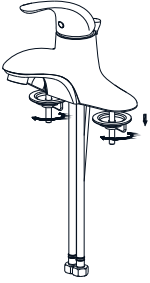

3 Insert faucet through holes.

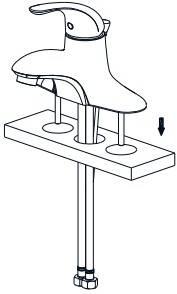

4 Reattach locking nuts (7). Tighten firmly by hand. Tighten an extra 1/4 turn.

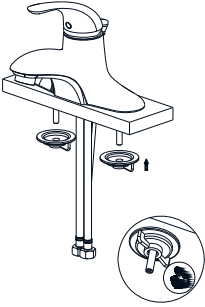

5 Connect hot & cold hoses to supply valves, tighten with adjustable wrench.

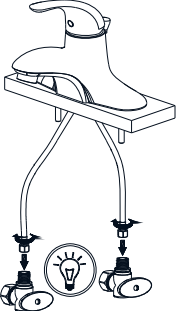

6 Remove stopper(17) and flange(16). Add a ring of silicone around underside of flange. Insert drain from underneath sink and tighten.

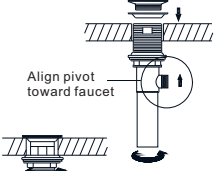

Align pivot toward faucet

Hand-tighten lock nut. Tighten 1/4 turn extra with a wrench.

7 Align stopper(17) opening with hole.

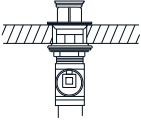

Remove pivot nut (13). Keep gasket in place and insert control rod (11) through stopper (18). Hand-tighten pivot nut (13).

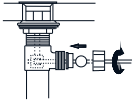

8 Insert one side of clip (12) on control rod (11). Insert control rod (11) through strap (10). Secure the other side of clip(12) on rod (11).

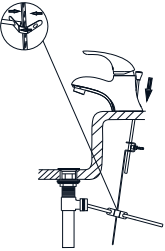

9A Remove aerator (6) from faucet.

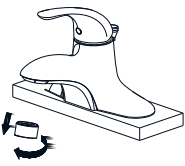

9B Turn supply valves on. Flush water through faucet to clear any debris.

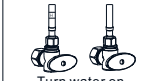
Turn water on.

9C Reattach aerator (6) to faucet.



TROUBLESHOOTING

If you've followed the instructions carefully and your faucet still does not work properly, take these corrective steps.

| PROBLEM | CAUSE | ACTION |
|--|---|---|
| Leaks underneath handle. | Retainer nut has come loose. O-ring is dirty or damaged. | Tighten the retainer nut. Clean or replace O-ring. If necessary, replace cartridge. |
| Aerator leaks or has an inconsistent water flow pattern. | Aerator is dirty or misfitted. | Unscrew aerator, remove any debris, check seating of rubber seal then re-assemble aerator. If necessary, replace aerator. |

Need help? For technical assistance or replacement parts, please contact Allora USA Customer Service and one of our representatives will be happy to assist you:

Call 571-291-3484 or email Customerservice@allorausea.com

CARE & MAINTENANCE

To keep the product clean & shining, follow the steps below:

1. Rinse with clean water & dry with a soft cloth
 2. Do not clean with soaps, acid, polish, abrasives or harsh cleaners
 3. Do not use cloth with a coarse surface
 4. Unscrew the aerator and clean when necessary
-



This product is engineered to meet the EPA WaterSense flow requirement. The flow rate is governed by the flow controller. If replacement is ever required, be sure to replace it with a WaterSense compliant flow controller to retain the water conserving flow rate of this product.

| No. | Description | Part No. |
|-----|-------------------------------|----------|
| 1 | Hot/Cold Indicator | AL4-10 |
| 2 | Metal Handle | |
| 3 | Trim Cap | |
| 4 | Lock Nut | |
| 5 | Ceramic Disc Cartridge (25mm) | AL1-04 |
| 6 | Aerator | AL4-09 |
| 7 | Locking Nuts | |
| 8 | Lift Rod | |
| 9 | Screw | |
| 10 | Strap | |
| 11 | Control Rod | |
| 12 | Spring Clip | |
| 13 | Pivot Nut | |
| 14 | Drain Lock Nut | |
| 15 | Washer Set | |
| 16 | Flange | |
| 17 | Stopper | AL5-02 |

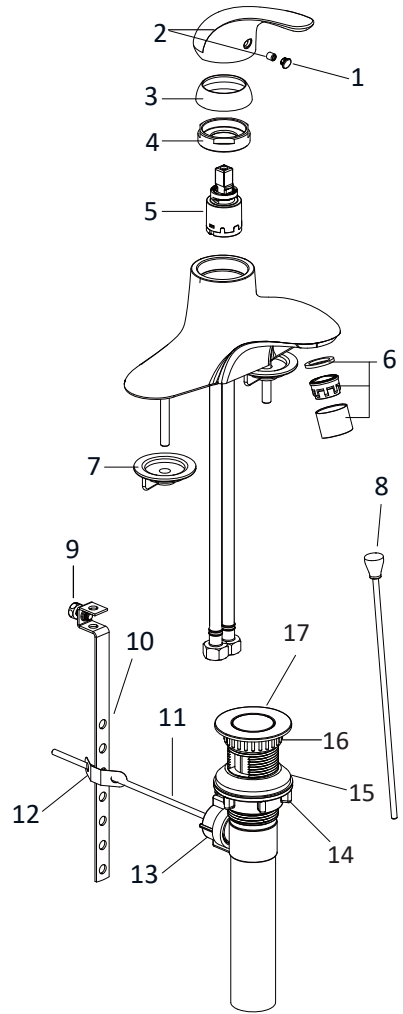

IMPORTANT

Register Your Allora USA Product

<http://www.alloraus.com/registration>

Activate Your Warranty

Access Premium Customer Support

Get Product Information



REGISTER TODAY