

B-101-C

SPECIFICATION SHEET

Kitchen Faucet
Single-Handle Faucet
Side-Spray Faucet



Codes and Standards

- a. cUPC ASME A112.18.1/CSA B125.1
- b. NSF/ANSI/CAN 61-2022
- c. EPA WaterSense

Product Features

- a. Installation: Deck Mounted
- b. Finish: Chrome
- c. Material: Stainless Steel 304 Construction, Zinc Handle
- d. Cartridge: Ceramic Disc
- e. Warranty: Limited Lifetime
- f. Side Spray: Included with Chrome Handle
- g. Max Flow Rate: 1.8 GPM at 60PSI



Accessories Included

- a. Hot/Cold Supply Hoses
- b. Installation Instructions

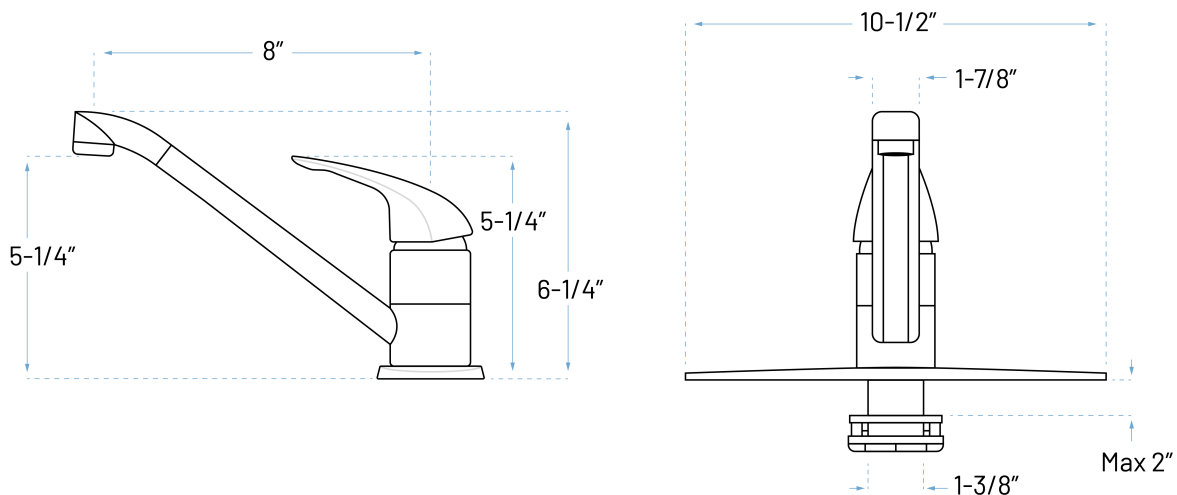

ADDRESS: 22713 COMMERCE CENTER COURT STE 140 DULLES, VA 20166
PHONE: 571-291-3484 | customerservice@allorausa.com
WEBSITE: www.allorausa.com

ALLORA USA NOTES / DISCLAIMER:
Allara USA is not responsible for, nor does it have any liability for any mistakes or typographical errors including liability for incidental, consequential, or special damages. Allara USA recommends that the model to be installed be present, inspected and measured prior to utilizing the related spec sheets and any work, preparations or alterations are made to any counter-top material. See website for detailed warranty information. Allora USA reserves the right to make revisions without notice to product specifications.

REV. Jun 28, 2023