

ADA-KH-2518-S-R20

SPECIFICATION SHEET

Stainless Steel - Tight Radius
Undermount Sink
ADA Compliant Kitchen Sink



Codes and Standards

- a. cUPC ASME A112.19.3/CSA B45.4
- b. Meets ADA guidelines and ANSI A117.1 requirements

Product Features

- a. Installation type: Under-mount
- b. Material: 304 Stainless Steel, 18 gauge
- c. Drain hole location: Rear
- d. Sound Pad

Technical Specs

- a. Drain Size : 3-1/2"
- b. Outer Dimensions : 25" x 18" x 5-1/2"
- c. Bowl Size : 23" x 16"
- d. Water Depth : 5-1/4"
- e. Cabinet Width : 27"
- f. Corner Radius : 20mm



Accessories Included

- a. Installation Clips
- b. Paper Template

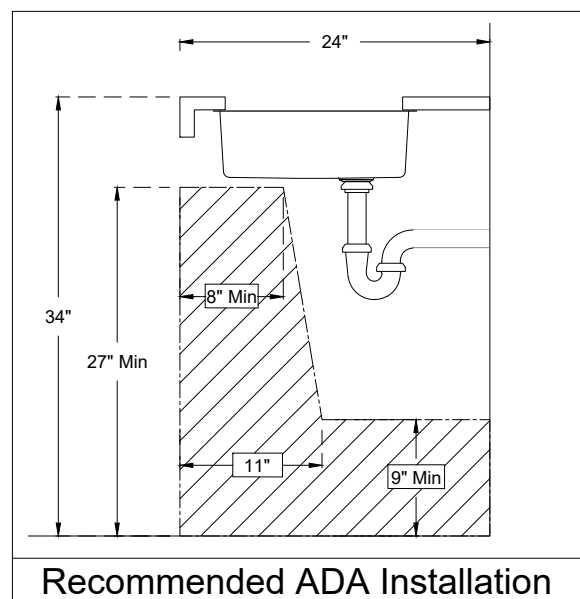
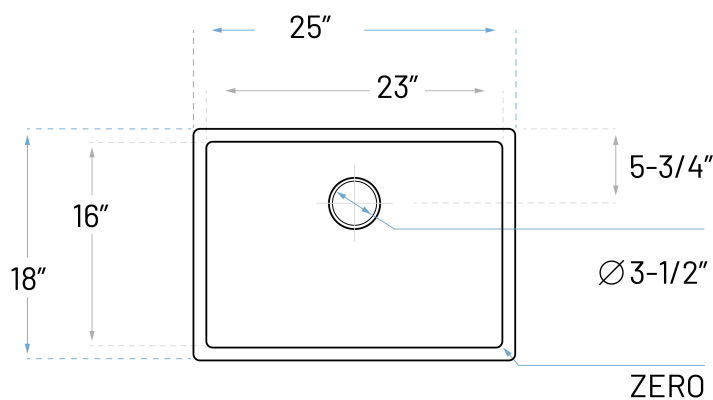

ADDRESS: 22713 COMMERCE CENTER COURT STE 140 DULLES, VA 20166
PHONE: 571-291-3484 | customerservice@allorausea.com
WEBSITE: www.allorausea.com

ALLORA USA NOTES / DISCLAIMER:

Allara USA is not responsible for, nor does it have any liability for any mistakes or typographical errors including liability for incidental, consequential, or special damages. Allara USA recommends that the model to be installed be present, inspected and measured prior to utilizing the related spec sheets and any work, preparations or alterations are made to any counter-top material. See website for detailed warranty information. Allara USA reserves the right to make revisions without notice to product specifications.