

ADULT ASSEMBLY REQUIRED



WARNING: Small Parts

Product contains small parts with potentially hazardous sharp points and sharp edges in the unassembled state. Keep unassembled parts away from children.



WARNING: Tipping Hazard

This toy has been rigorously tested to meet all toy tipping safety standards; however, this toy is **not meant** to be climbed on. Serious injury can occur with improper use.

- Do not allow children to climb on or hang from this product
- Place product on flat, level surface only
- Do not place heavy objects on top of this product
- Keep back of this product against a flat wall
- Follow age guidelines for this product

Assembly Instructions

1. Upon opening package, please inspect contents to make sure all parts and components are accounted for.
2. Place contents on padded or carpeted surface to avoid damage.
3. Please read assembly instructions carefully.

Use and Care

Use on level surfaces only, and routinely check hardware and tighten as necessary. Failure to maintain your new product may result in unsafe conditions for children.

We build our toys with years of future play in mind, so to ensure a long lifespan for your product, surface clean only with a dry soft cloth. To clean small stains, use a slightly damp cloth and if necessary, a mild detergent. Wipe all spills immediately and avoid using any abrasive cleaning agents or scrubs, including ammonia or alcohol based formulas.

For more information on how to care for your new toy, please visit www.miltonandgoose.com.



MILTON & GOOSE

Essentials Play Kitchen

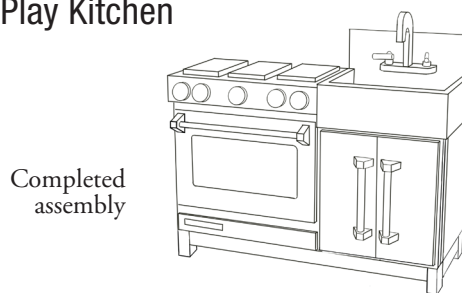

Parts

- 1 cabinet (A)
- 1 sink backboard (B)
- 1 faucet (C)
- 4 legs (D)
- 4 wingnuts (E)
- 7 1½" screws (F)

Tools Required

Philips-head screwdriver

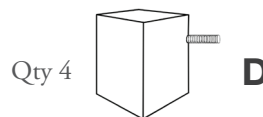
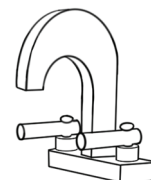
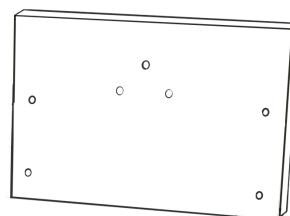
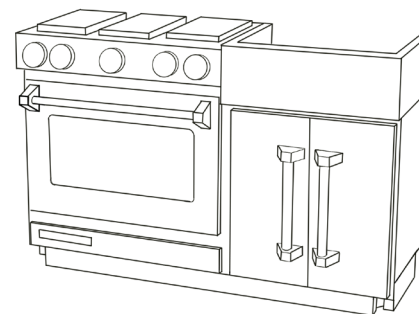
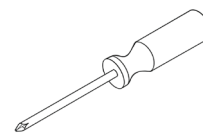

Directions



Loosely attach all screws and then tighten once all screws are in place. **Be careful not to over-tighten**, otherwise cracking of the wood can result.



Step 1

Attach 4 legs (E) to cabinet (A) with wingnuts (F). Turn wingnuts clockwise until tight and securely attached.

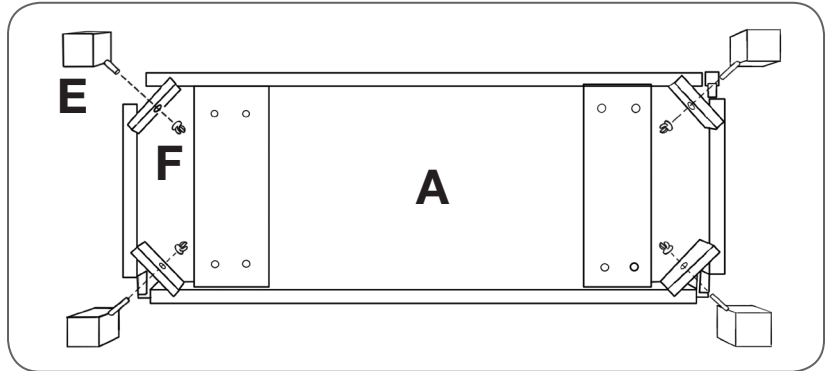

Step 2

Insert all screws through pre-drilled holes first!

Attach sink backboard (B) with 4 screws (F) in pre-drilled holes at back of sink backboard. Secure screws.

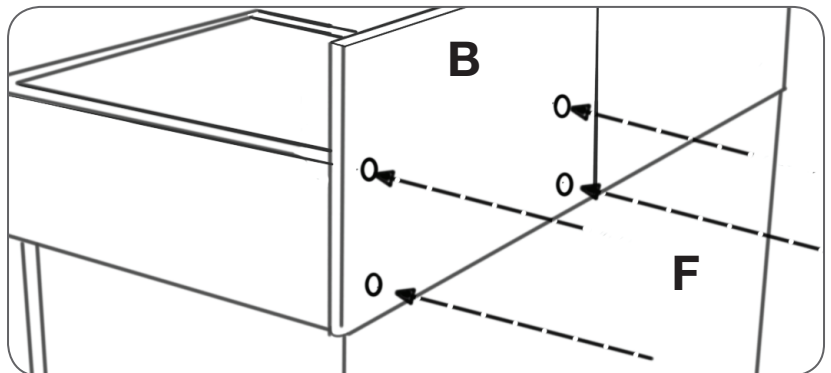

Step 3

Insert all screws through pre-drilled holes first!

Attach faucet (C) to sink backboard with 3 screws (F) in pre-drilled holes at back of sink. Secure screws.

