

NORTHERN KENTUCKY CEDAR, LLC

## **Deluxe Cubby Add-On Assembly**

1. Use caution when assembling this unit. Excessive weight will cause damage to the unit. Serious or fatal injuries may occur from the unit falling if not properly fastened to the wall.
2. Products that are instructed to be fastened to the wall must either be connected to a stud or by drywall anchors (not included).
3. Each unit may be attached to another or cut down to fit your needs. With that in mind; Plan ahead. Assemble each unit one at a time, and only cut down pieces when you are confident that they will fit together.
4. Determine if your unit will fit in the desired space. The only cuts you should make prior to assembly are on the panels of a cubby unit, so they will fit when standing up-right.
5. If you purchased a cubby add-on, please refer to the instructions included with that unit before assembling anything. Special steps must be completed prior to installing this unit.
6. This unit is installed faster and much easier with the help of others.

**For Support:**

Call toll free 855.239.9498 or 606.742.2745      Email - [sales@northernkycedar.com](mailto:sales@northernkycedar.com)

Once your unit is complete, we would love to see it! Send us pictures at our Email!

# Thank You For Your Purchase

Because this system is based around the concept of individuality, this system can be used in conjunction with any Northern Kentucky Cedar, LLC product. The different ways are limited only by your imagination, and as such, not all components have to be used during installation.

To ensure a proper and easy installation, thoroughly read and follow this document. Basic carpentry skills will help.

This system is designed for clothes, linens, and pantry items. Placing excessively heavy items in your closet may lead to structural failure.

Knots, checking, and light cracks are typical characteristics of Aromatic Red Cedar and do not warrant a cause for exchange or refund.

If scent wears off, lightly sand with a fine sandpaper to revitalize scent.

**If you purchased a cubby add-on please refer to the instructions included with that unit before assembling anything. Special steps must be completed prior to installing this unit.**

## Tools you will need



Safety Glasses

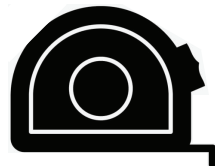

Tape Measure



Cup of Water

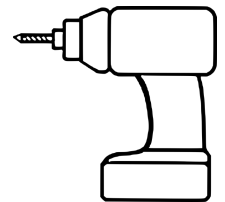

- 1/16" Drill Bit
- 1/8" Drill Bit
- #2 Square Bit



Hammer



Stud Finder



Level

**Your Kit Will Include**



B1 - (x6) 1" Screws

C1 - (x6) 2" Screws

D1 - (x3) 3" Screws

(Kit may contain extra hardware)

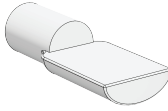

E1 - (x12) Shelf Support Pegs



F1 - (x6) L-Brackets



G1 - (x6) Add-On Shelf Pegs

x1 Top Panel  
x1 Bottom Panel (notched for baseboards)

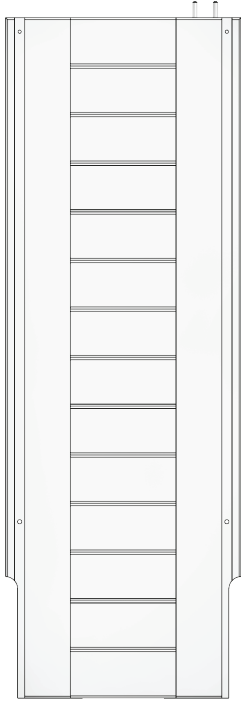
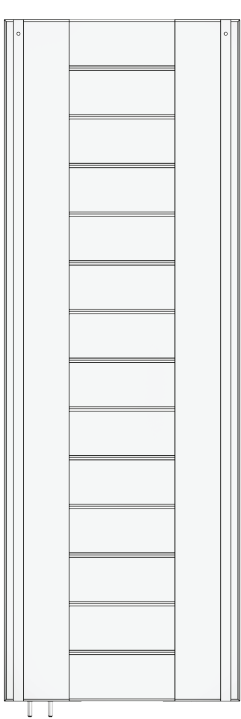

Shelves will be Ventilated or Solid depending on your order

x3 Pre-drilled Shelves of ordered size

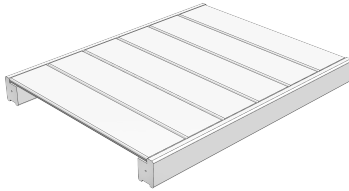
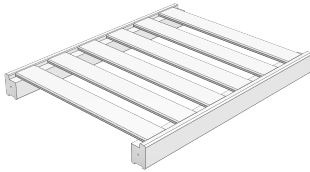

x3 Adjustable Shelves of ordered size

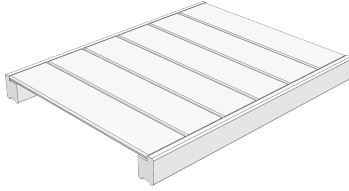
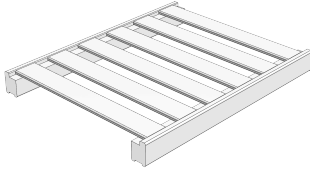

Note: The Panel set that comes with your Add-On will have the holes drilled through all the way.

## Step 1 - Prepare the other Units

It is to assemble the Add-On when you are installing your closet for the first time. If this is a unit that you are adding to your installed system these instructions will still apply.

Have your instructions ready for the unit that you will be attaching this cubby Add-On to. Not that you can only use this unit on a Cubby Unit, Corner Cubby Unit, or Shoe Cubby Unit.

If you are adding to a Cubby Unit:

- Use the Cubby instructions and the assemble the unit until you reach step 4 on pg. 7. Complete that step then refer to his guide.

If you are adding to a Shoe or Corner Cubby Unit:

- Use the instructions that came with that unit and assemble the unit until you reach step 4 on pg. 6. Complete that step then refer to this guide.

## Step 2 - Add-On Explained

Cubby Add-Ons are designed to attach to an existing Cubby Unit. You must read the Cubby Instructions that came with your other unit. STOP at step 4 and refer back to these instructions.

Set that comes with Add-On.

①

Sets that come with other Cubby Unit.

②

Basically take the Panel Set that came with the Add-On and replace it with a Panel Set on any Cubby. That will allow you to make that section an Add-On. Look to the picture on the right to see an exploded view of a Cubby Unit and Add-On Unit with the Panel Set already replaced with the Add-On Panel Set.

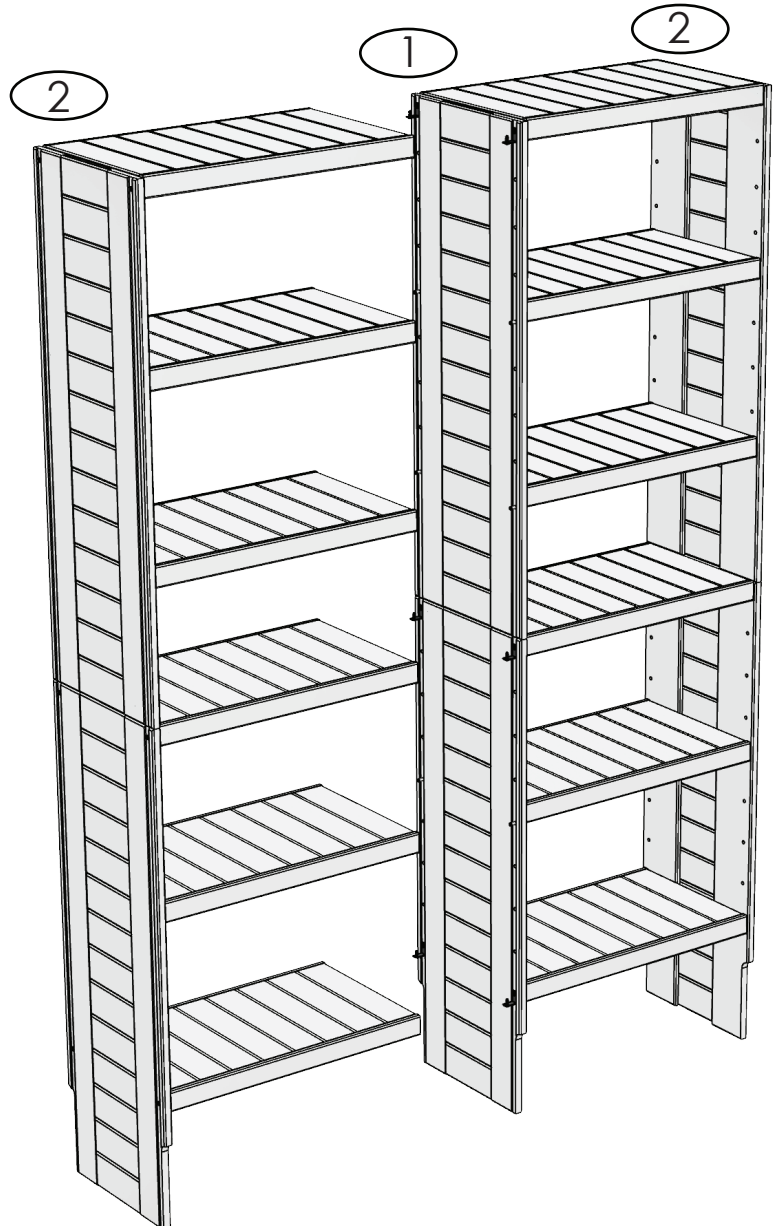



## Step 3 - Assemble Cubby Unit To Step 4

Attach each pre-drilled shelf following the numbers below

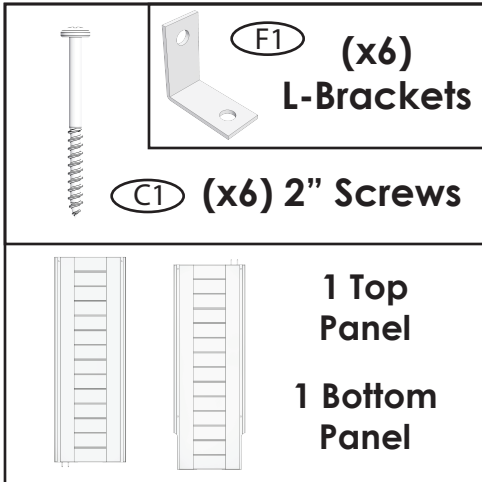

After you have completed the assembly of the Cubby Unit up to this point (Step 4 of the Cubby Instructions)

Flip your Unit over and attach the Add-On Panel Set as shown.

Once you have completed this step move on and finish the other part of the Cubby Unit.

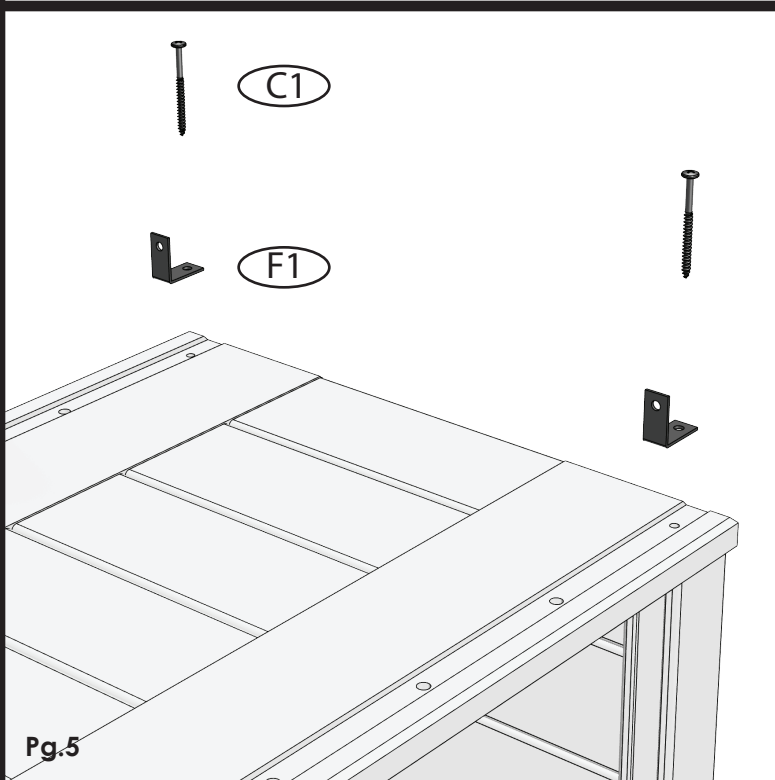
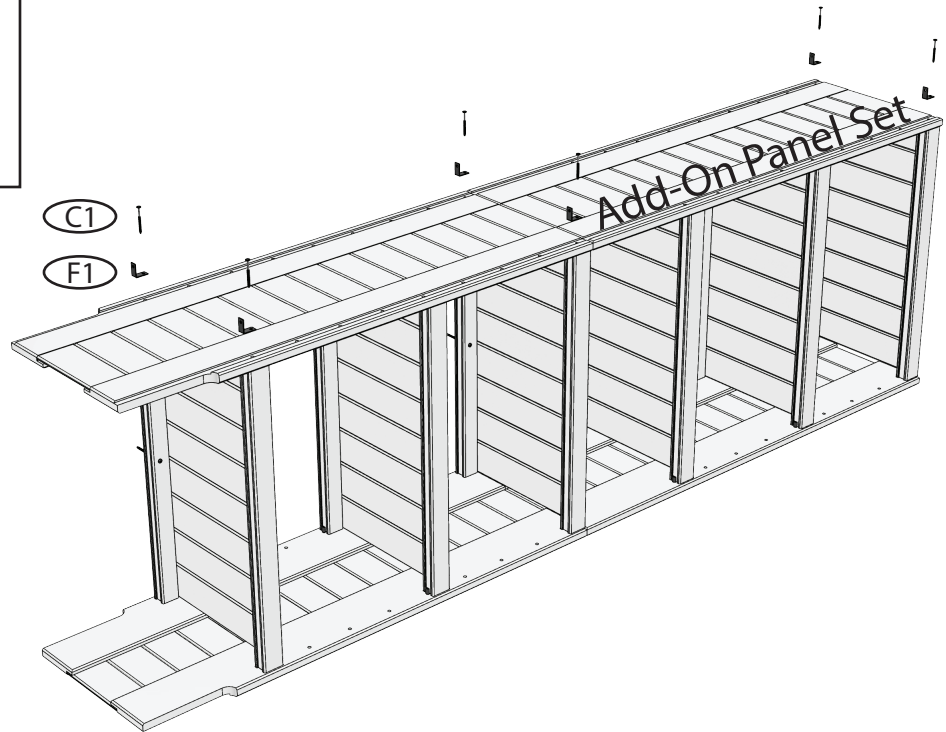

## Step 4 - Finish Cubby Unit & Add-On

Repeat Steps 3 & 4 of the Cubby Instructions.

The Result should look like this.

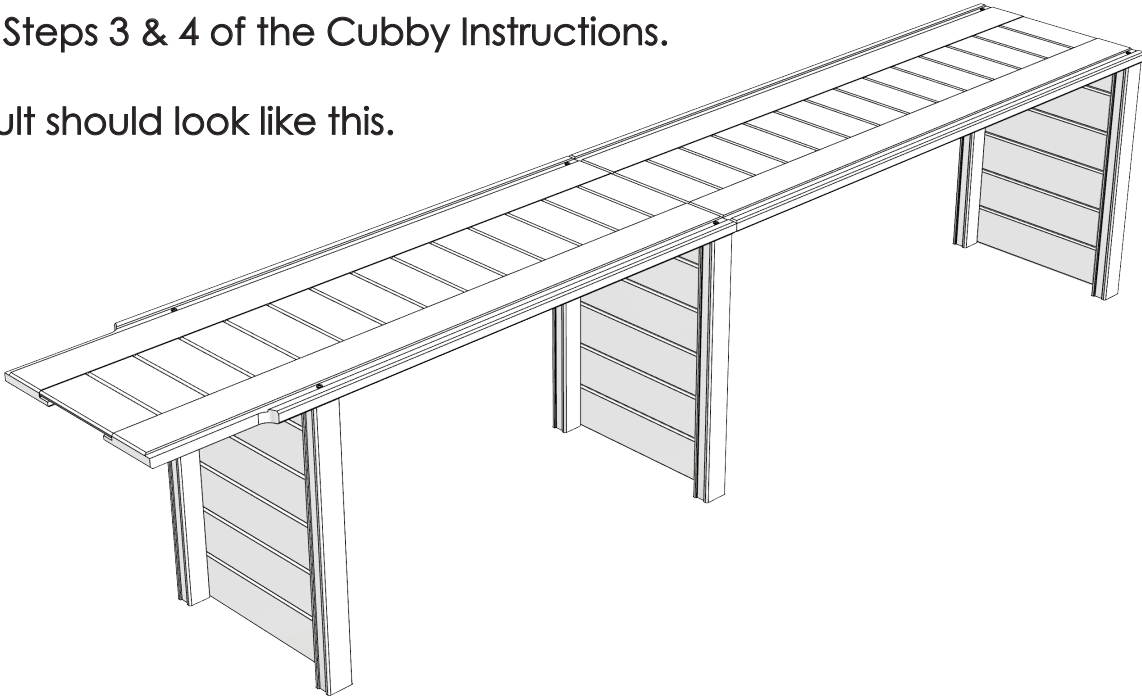

## Step 5 - Assemble Cubby Unit (Pt 3)

Take caution when standing the Add-On up to attach it to your Cubby. Make sure the Cubby is properly fastened to the wall.

Use the L-Brackets (F1) to steady the unit, make sure the unit is level. You can bend the L-Brackets to make the unit more square if needed.

Attach the two units using 1" Screws (B1) through the L-Brackets into the free shelves.

Once it is complete be sure to anchor the shelves to the wall using 3" Screws (D1) into studs.

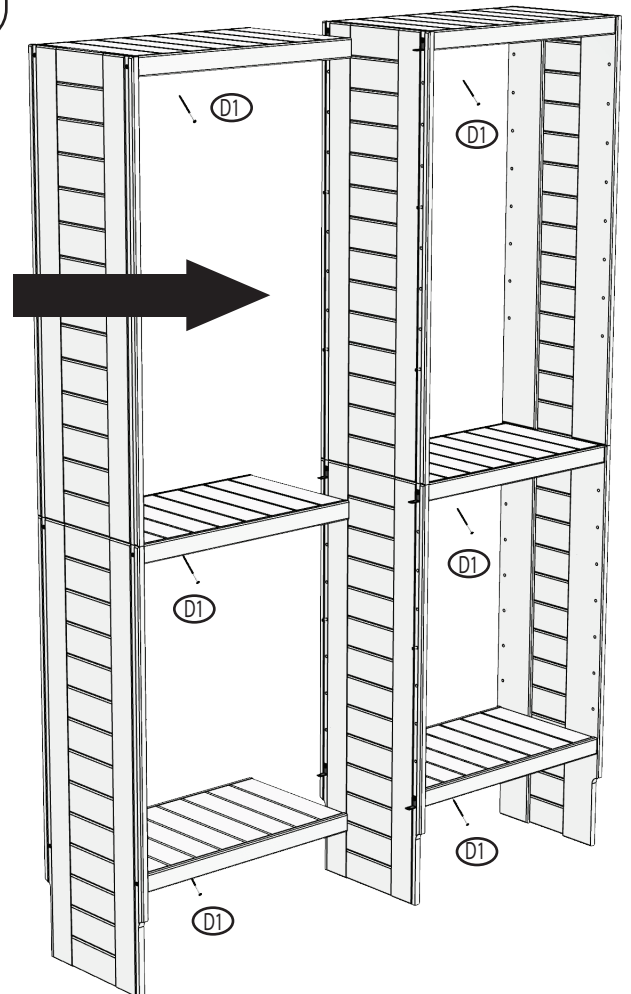

## Step 6 - Place Cubby Unit

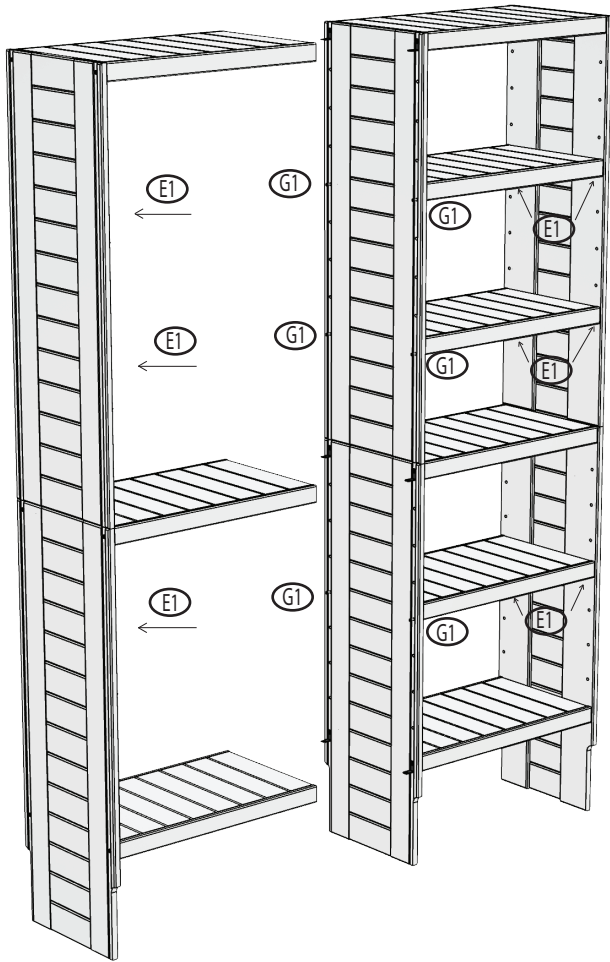

Stand the Cubby Unit (with the Add-On panels you attached earlier) up in position where it will remain as a part of your closet.

Refer to your Cubby Instructions to complete the install of the Cubby.

Place Add-On Shelf Pegs (G1) through the holes to support the middle of your adjustable shelving.

Place Shelf Pegs (E1) on both outside edges of your Cubby and Add-On to place the remaining adjustable shelving.

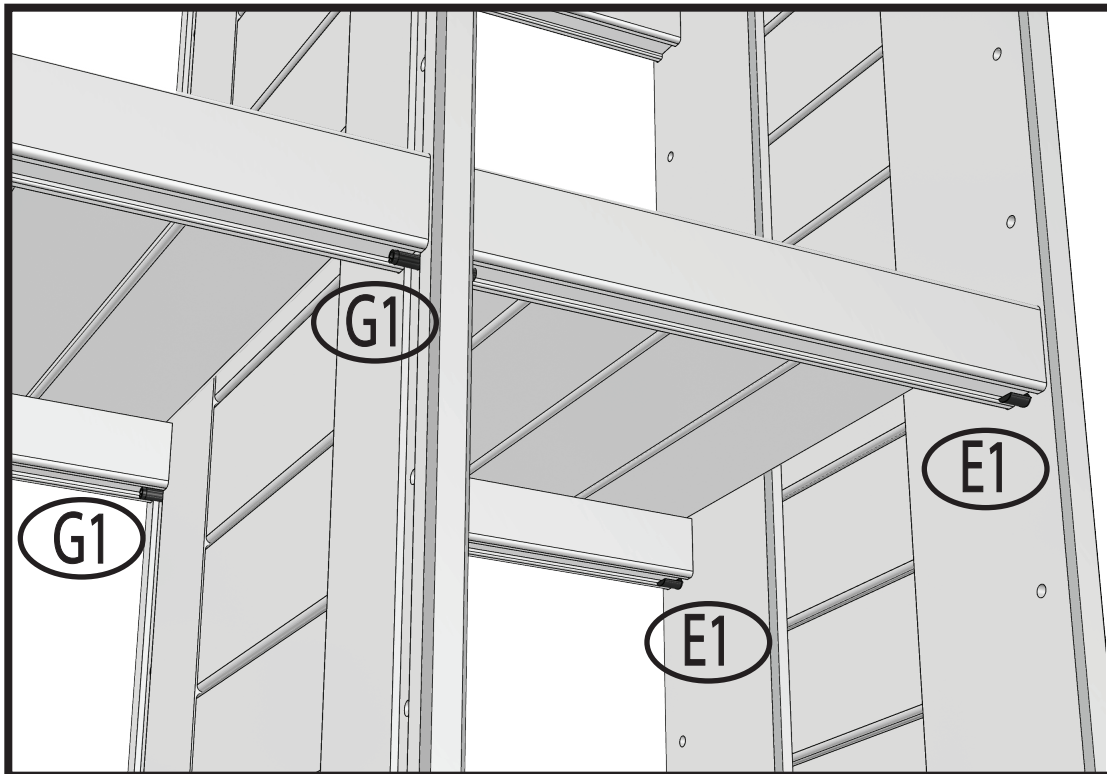

Attaching a Cubby Add-On to a Shoe Cubby requires the use of 2" Screws (C1), Shelf Pegs (E1), and Add-On Shelf Pegs (G1) to connect the shelves to the Panel as shown in the images below.

