

power  
2 GO

# PL-300

Mains / Rechargeable Portable Low Glare Lighting Tower.

Portable 360  
degree  
Lighting  
System



# LIGHTER, BRIGHTER, FASTER DEPLOYMENT

10-second rapid expansion, easy adjustment  
of four lighting angles.



Original petal-shaped adjustable  
head offers 360-degree wide-angle  
illumination, from all directions to  
directly below the light.



Ground pegs are available  
to secure the light tower,  
providing wind and  
vibration resistance.  
**(Optional)**

One-click release or  
lock of the legs.

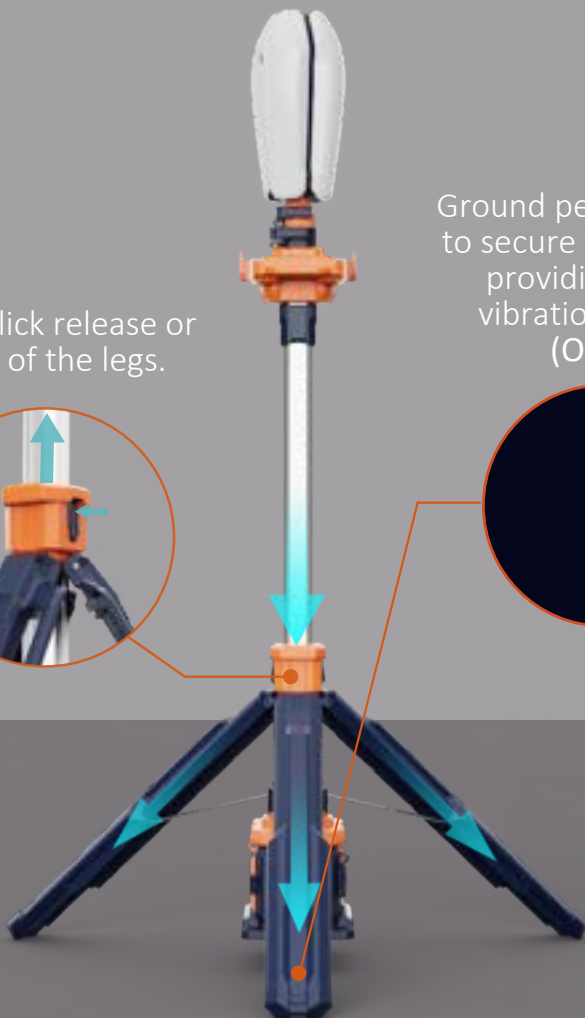

# CREATIVE DESIGN HIDDEN IN THE DETAILS

---



## 360° Lighting.

Biomimetic petal-inspired design for lightweight spherical/hemispherical lighting product.



## USB Output

Dual rainproof USB outputs for charging two devices at once, rain or shine.

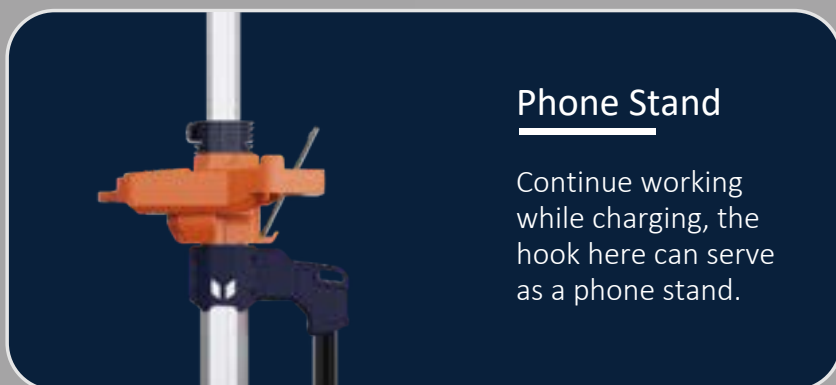

## Phone Stand

Continue working while charging, the hook here can serve as a phone stand.



## Stepless Dimming

Plug the driver into the rainproof port to unlock maximum brightness and stepless dimming.

# LOWER CENTER OF GRAVITY, GREATER STABILITY

---

Ultra-low center of gravity combined with extended legs effortlessly handles strong winds.



# Ultra-long Duration Standard Mode Up To 13+Hours

(D24-100 x 2)

Battery compartment fits two replaceable battery packs.



2 types of battery packs with different capacities have same contact slot.



D24-54 x 2



D24-100 x 2

Typical working hours 36+ hours on PL-300 Eco mode.

Doubled typical working hours to 71+ hours.

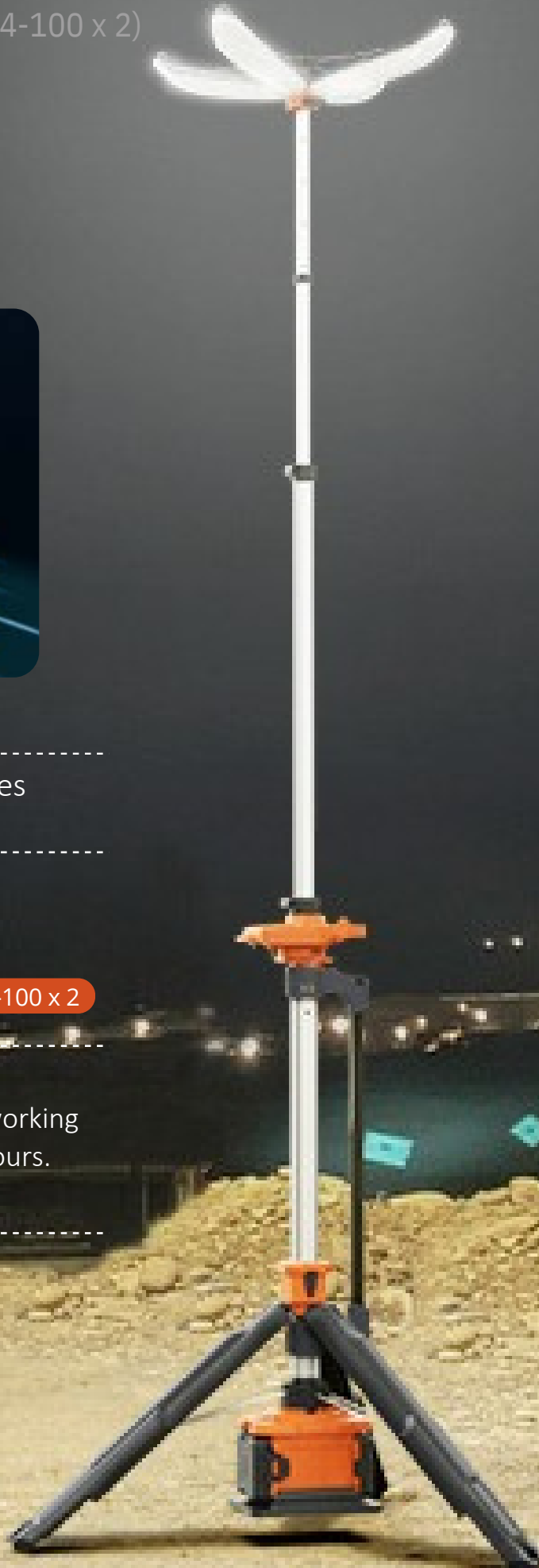

# Uniform and low-glare 360-degree illumination, leaving no dark spots.

▪ Lighting Area 2200 m<sup>2</sup>

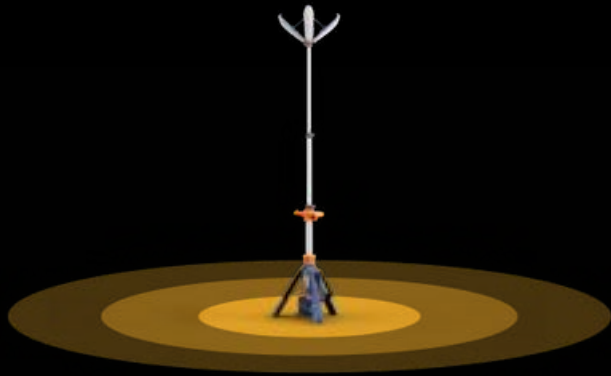

AC Powered

Up To **14,000 Lumens**

Battery-

powered Up To **8000 Lumens**

**Stepless Dimmable** ( AC Powered)



**4 levels of Brightness** (Battery Powered)

Eco      Balanced      Standard      Turbo

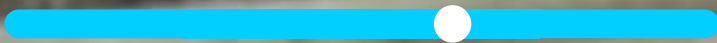

800LM      3000LM      5000LM      8000LM



Construction



Maintenance



Rescue



Emergency



Railway



Mining

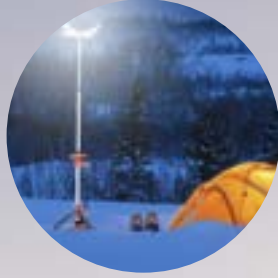

Camping

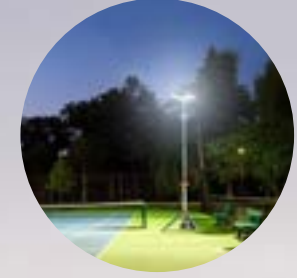

Sport

## Designed for single-person operation

Easy to grip and move, weight 8.8 kg excluding battery pack.



1.58m

3.4m



# Specifications

## PL-300

Height	1.58m~3.4m
Weight	8.8Kg (Fitting only)
Power	D24 series battery pack / AC 100-277V
Supply	0 - 14,000Lm
Lumens	>13 hours (Standard mode, D24-100 x
Run Times	2) IP66
IP Grade	5V 2A (2 Dock)
Output(USB)	



## Size (mm)

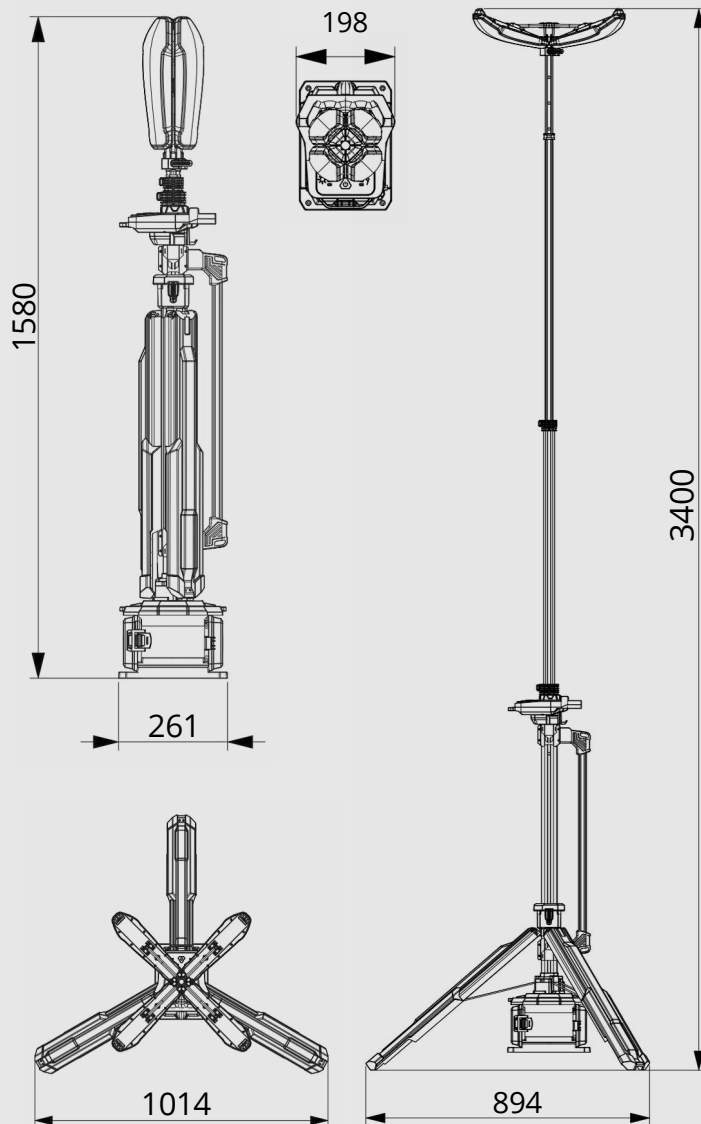

## Package

Model	PL-300
Size of Carton	1660x280x390mm
Gross Weight of Carton	13KG
PC S/Carton	1



Power-2Go  
Unit C, Buckshaw Link, Ordnance Road,  
Chorley, Lancashire PR7 7E

Tel 01934 900471  
Web: [www.power-2Go.com](http://www.power-2Go.com)  
Email: [info@Power-2Go.com](mailto:info@Power-2Go.com)