



DIMENSIONS

66 x 35 x 25 deep (1676 x 889 x 635 mm)
Gallon to Overflow = 70 (Liters = 265)

MATERIAL

Acrylic

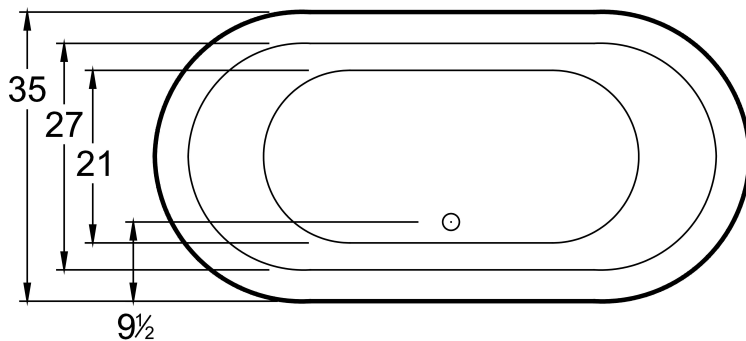

TUB FLOOR

Non-Textured

UNDERMOUNT: NO

This tub is not designed for undermount installation.

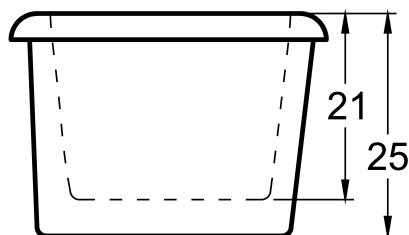
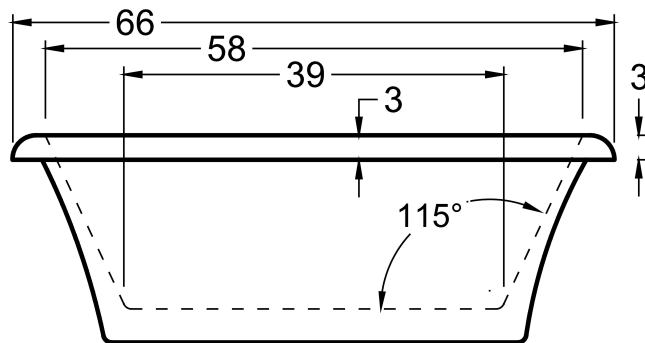

APPROVALS & COMPLIANCE



Americh products meet or exceed the following standards:

- Underwriters Laboratories (UL)
- Underwriters Laboratories - Canada (cUL)
- ANSI Z124.1 • ANSI A112-19.7
- ANSI A112.19.8

Contact Americh for additional approvals.

LEGEND



Remote Blower Connection



REMOTE CONTROL
(With INVISIBLE MAGNETIC HOLDER)

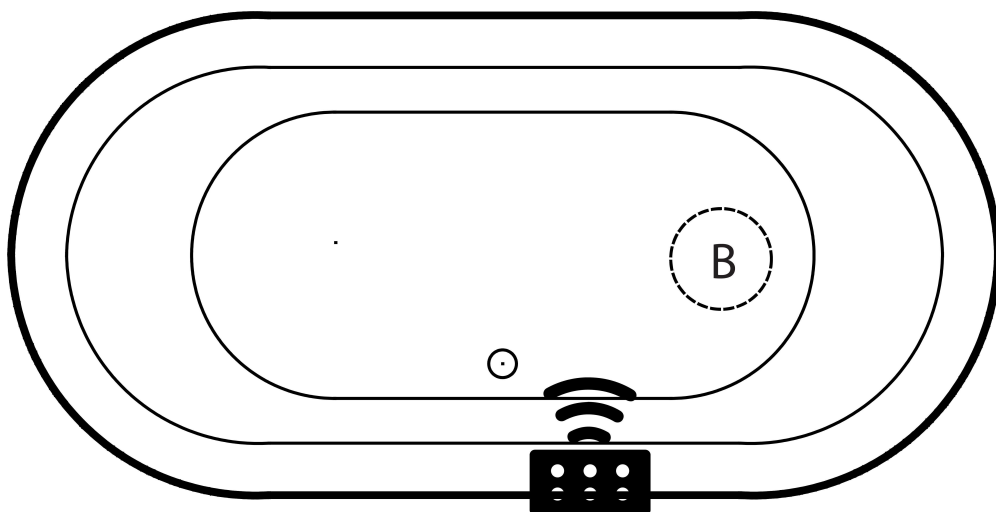

Airbath System III
Blower must be remotely located
(Diagram is required for custom blower connection locations)

STANDARD EQUIPMENT

- Americh Remote Control (with AirBath System only)
- Integral Waste & Overflow
- Lift Bag Included

OPTIONAL ACCESSORIES

- Dual Color (Premium Color Upcharge)
- Linear Waste & Overflow Upgrade
- Pillows: 12" - Angle

INSTALLATION TIPS

- Install according to Owner's Manual and local codes.
- Always consult your local plumber for recommendations as installations will vary.
- The bath must be secured to the floor by applying a bead of silicone around the base.
- Installation must be carried out according to the manufacturer instructions.
- Hot water supply should be 65-75% of tub capacity or greater.
- Tubs with Airsystem may require piping thru the subfloor. Bathrooms on concrete slab may require modification to the tub or installation on a platform to run air piping to the blower in a remote location. (Remote Blower Location Required)

ELECTRICAL REQUIREMENTS

Americh recommends one 20 amp ground fault circuit interrupter (GFCI) for each power supply provided with the bathtub.