



### DIMENSIONS

42 x 42 x 33 deep (1067 x 1067 x 838 mm)  
Gallon to Overflow = 78 (Liters = 295)

### MATERIAL

Acrylic

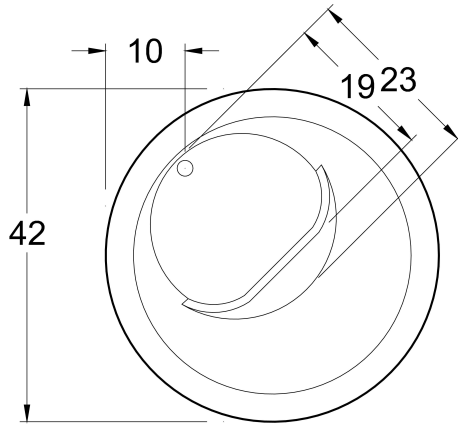

### TUB FLOOR

Non-Textured

### UNDERMOUNT: NO

This tub is not designed for undermount installation.

### APPROVALS & COMPLIANCE



Americh products meet or exceed the following standards:

- Underwriters Laboratories (UL)
- Underwriters Laboratories - Canada (cUL)
- ANSI Z124.1 • ANSI A112-19.7
- ANSI A112.19.8

Contact Americh for additional approvals.

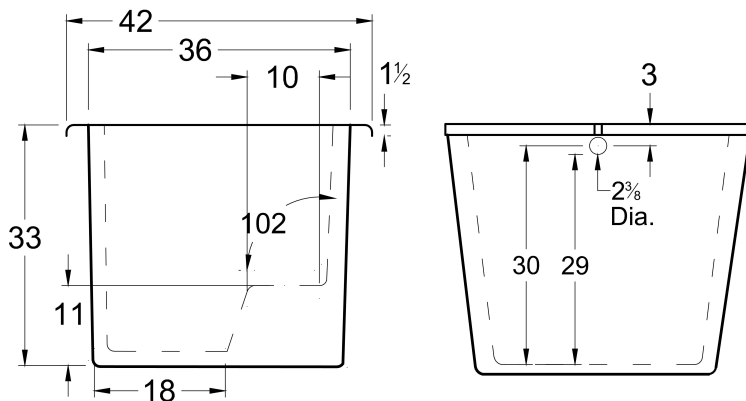

**LEGEND**



Remote Blower Connection



REMOTE CONTROL  
(With INVISIBLE MAGNETIC HOLDER)

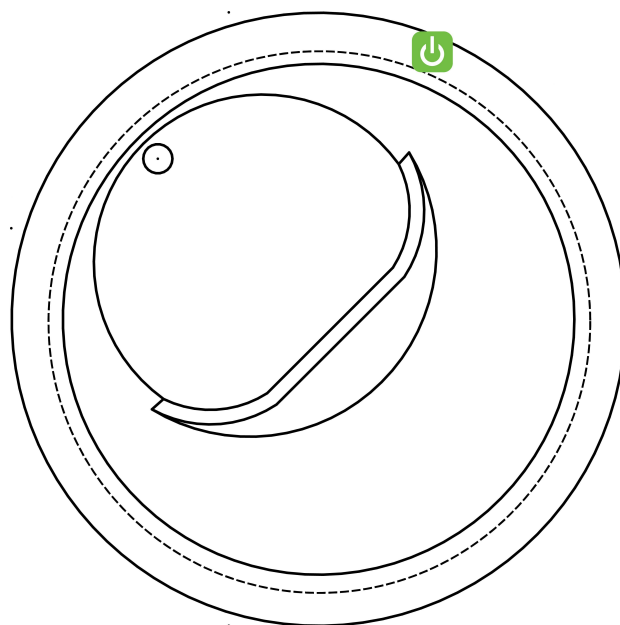

**Airbath System II**

Blower must be remotely located  
(Diagram is required for custom blower connection locations)

**STANDARD EQUIPMENT**

- Americh Remote Control (with AirBath System only)
- Integral Waste & Overflow
- Lift Bag Included

**OPTIONAL ACCESSORIES**

- Dual Color (Premium Color Upcharge)
- Linear Waste & Overflow Upgrade
- Pillows: 12" - Angle

**INSTALLATION TIPS**

- Install according to Owner's Manual and local codes.
- Always consult your local plumber for recommendations as installations will vary.
- The bath must be secured to the floor by applying a bead of silicone around the base.
- Installation must be carried out according to the manufacturer instructions.
- Hot water supply should be 65-75% of tub capacity or greater.
- Tubs with Airsystem may require piping thru the subfloor. Bathrooms on concrete slab may require modification to the tub or installation on a platform to run air piping to the blower in a remote location. (Remote Blower Location Required)

**ELECTRICAL REQUIREMENTS**

Americh recommends one 20 amp ground fault circuit interrupter (GFCI) for each power supply provided with the bathtub.