



WWW.BACKUPBATTERYPOWER.COM

(855) 330-7799

**Intelligent Advanced Digital 1.0
Power Factor On-Line UPS**

User Manual

4.5, 6 ,8,10 kVA

Table of Contents

1.	Safety Instructions and Battery Care.....	2
1.1.	Safety Instructions-----	2
1.2.	Battery Care-----	5
2.	Product Introduction	6
2.1.	General Characteristics-----	6
2.2.	Symbols on the LCD Display Panel-----	9
2.3.	Panel Explanation-----	12
2.4.	Communication Port-----	17
3.	Installation and Operation.....	18
3.1.	Unpacking-----	18
3.2.	Selecting Installation Position-----	19
3.3.	Installation of Accessories-----	19
3.4.	Terminal Block Explanation-----	20
3.5.	Installation and Operation-----	22
4.	Troubleshooting Guide	35
4.1.	Troubleshooting-----	35
4.2.	Battery Replacement-----	36
5.	Communication Software	38
5.1.	Hardware Setup-----	38
5.2.	Software Installation-----	38
6.	Optional Interface Cards.....	39
6.1.	R2E (RS-232) card-----	39
6.2.	RSE (RS-485) card-----	39
6.3.	DCE (Dry Contact)-B card-----	40
6.4.	DCE (Dry Contact)-C card-----	40
6.5.	SNMP Card-----	41
6.6.	Interface Card Installation-----	41
7.	Specifications - 4.5kVA/6kVA	42
8.	Specifications - 8kVA/10kVA	45

1. Safety Instructions and Battery Care

1.1. Safety Instructions

- 1.1.1. Because of small leakage currents generated by the EMI filter in the UPS it is necessary to double check that the ground wire of the UPS is properly grounded before connecting the UPS to the AC mains.
- 1.1.2. To ensure safety in all applications where a UPS is hard wired to the electrical supply, ensure that the system is installed by a qualified electrical contractor.
- 1.1.3. The UPS has its own internal energy source (battery). Should the battery be switched on when no AC power is available there could be voltage at the output terminals.
- 1.1.4. Make sure that the AC utility outlet is correctly grounded.
- 1.1.5. Do not open the case as there are no serviceable parts inside. Opening the case voids the warranty.
- 1.1.6. Do not try to repair the unit yourself; contact your local supplier. Repairing the unit yourself voids the warranty.
- 1.1.7. Please make sure that the input voltage of the UPS matches the supply voltage.
- 1.1.8. Use a certified input power cable with the correct plugs and sockets for the appropriate system voltage.
- 1.1.9. To prevent any overheating of the UPS keep all ventilation openings free from obstruction, and do not store things on top of the UPS. Keep the UPS 30 cm away from the wall.
- 1.1.10. Ensure that the UPS is installed within the proper environmental range. (0-40°C and 0-90% non-condensing humidity)
- 1.1.11. Do not install the UPS in direct sunlight. Your warranty may be void if the batteries fail.
- 1.1.12. Install the UPS indoors as it is not designed for installation outdoors.
- 1.1.13. Dusty, corrosive and salty environments can damage any UPS.
- 1.1.14. Install the UPS away from objects that give off excessive heat and areas that are excessively wet.

- 1.1.15. If liquids are spilt onto the UPS or foreign objects dropped into the unit the warranty will be null and void.
- 1.1.16. The battery will discharge naturally if the system is unused for a long time.
- 1.1.17. The UPS should be recharged every 2-3 months if unused. If this is not done then the warranty will be null and void. When installed and being used the batteries will be automatically recharged and kept in top condition.
- 1.1.18. This UPS supports electronic equipment in office, telecommunication, process-control, medical, and security applications. Non-authorized technicians are not allowed to install the UPS in the following areas.
 - a. Medical equipment directly related to human life
 - b. Elevators, subway systems, or any other equipment related to human safety.
 - c. Public systems or critical computer systems.
- 1.1.19. Do not install the UPS in an environment with sparks, smoke or hazardous gas.
- 1.1.20. Make sure the UPS is completely turned off when transporting it. It might cause electrical shock if the output is not cut completely.
- 1.1.21. The UPS includes a Maintenance Bypass Switch. Please follow the procedures strictly when switching on or off the Maintenance Bypass Switch.
- 1.1.22. The UPS offers a CVCF (Constant Voltage Constant Frequency) setting function.
 - a. For correct setting and wiring please contact with your local utility agent.
 - b. Do not set it yourself or your warranty will be void.
- 1.1.23. This UPS has been designed and constructed to protect your assets from the wide range of power aberrations experienced on utility power lines today. It is your insurance for a reliable, clean and stable voltage supply. It is worth taking care to install the system correctly and to have it maintained correctly by your local dealer.
- 1.1.24. **SAVE THESE INSTRUCTIONS.** This manual contains important instructions that should be followed during installation and maintenance of the UPS and batteries.

- 1.1.25. The UPS is intended for installation in a controlled environment.
- 1.1.26. CAUTION: A disconnect switch must be provided by others for the AC output circuit. To reduce the risk of fire connect only to a circuit provided with branch circuit over-current protection for 30 amperes for 4.5k/6k VA rating or 50 amperes for 8k/10k VA rating in accordance with the National Electric Code, ANSI/NFPA 70.
- 1.1.27. CAUTION: To reduce the risk of fire connect the UPS only to a circuit provided with branch circuit over-current protection for 45 amperes for 4.5k/6k VA rating or 75 amperes for 8k/10k VA rating in accordance with the National Electric Code, ANSI/NFPA 70.
- 1.1.28. Install the UPS so that it is not likely to be contacted by people.
- 1.1.29. The maximum ambient operating temperature is 40°C or equivalent.
- 1.1.30. Units are considered acceptable for use in a maximum ambient 40°C
- 1.1.31. CAUTION - RISK OF EXPLOSION IF BATTERY IS REPLACED BY AN INCORRECT TYPE. DISPOSE OF USED BATTERIES ACCORDING TO THE INSTRUCTIONS.
- 1.1.32. CAUTION - Do not dispose of batteries in a fire. The batteries may explode.
- 1.1.33. CAUTION – Do not open or mutilate batteries. Released electrolyte is harmful to the skin and eyes. It may be toxic.
- 1.1.34. CAUTION– A battery can present a risk of electrical shock and high short circuit current. The following precautions should be observed when working on batteries:
- 1) Remove watches, rings, or other metal objects.
 - 2) Use tools with insulated handles.
 - 3) Wear rubber gloves and boots.
 - 4) Do not lay tools or metal parts on top of batteries.
 - 5) Disconnect charging source prior to connecting or disconnecting battery terminals.
 - 6) Remove battery grounds during installation and maintenance to reduce likelihood of shock. Remove the connection from ground if any part of the battery is determined to be grounded.

1.1.35. UPS can be used with only one Battery Cabinet.

1.1.36. When UPS without Backfeed relay board, Backfeed protection device (e.g., Magnetic Contactor) must be provided external to the equipment in final installation.

There is no standard backfeed protection inside, please isolate the UPS before working according to this circuit. The isolation device must be provided with suitable electrical ratings which compatible with the UPS

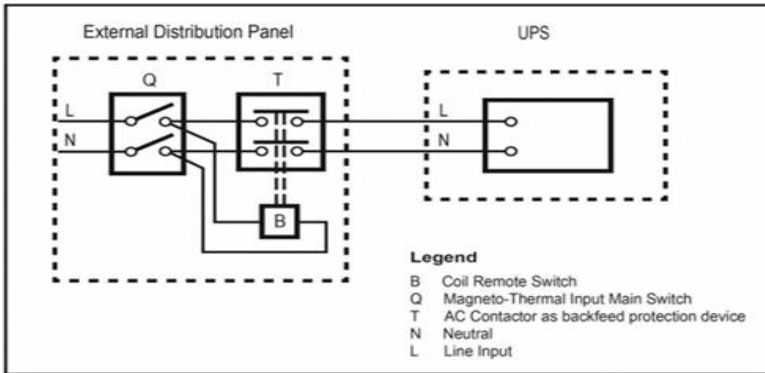

Before working on this circuit

- Isolate Uninterruptible Power System (UPS)
- Then check for Hazardous Voltage between all terminals including the protective earth.

 **Risk of Voltage Backfeed**

1.2. Battery Care

If the UPS is unused for an extended period of time it must be stored in a moderate climate. The batteries should be charged for twelve hours every three months by plugging the UPS power cord into a wall receptacle and turning on the input breaker on the front panel. Repeat this procedure every two months under a high-temperature environment.

2. Product Introduction

2.1. General Characteristics

- 2.1.1. True online architecture continuously supplies your critical device with stable, regulated, transient-free, pure-sine-wave AC power.
- 2.1.2. 20 kHz PWM sine-wave topology yields excellent overall performance. The high crest factor of the inverter handles all high-inrush current loads without a need to upgrade the power rating.
- 2.1.3. The multi-functional LCD/LED panel displays various states of the UPS. The LED display shows the UPS working status, utility status and abnormal status. The LCD display shows input/output voltage, frequency, load status, inner cabinet temperature, and abnormal phenomena.
- 2.1.4. To protect the unit from overloading, it automatically switches to bypass mode in 600 ~ 30 seconds s if loading is at 105 ~125% of rating. In case of overloading at 125 ~150% of rating, it switches to bypass mode in 30 seconds ~ 160ms. In case of overloading at 150% of rating, it switches to bypass mode immediately. It will automatically switch back to inverter mode once the overload condition ceases.
- 2.1.5. Should the output become short-circuited, the UPS cuts the output automatically until the short-circuit situation is removed manually.
- 2.1.6. Should the unit become overheated, the internal thermal switch will detect the heat and switch to bypass mode and vice versa.
- 2.1.7. The fully digitalized control circuit built into the UPS allows upgrading the functionality of the UPS as well as reaching a high-level of protection of the UPS. Powerful communication capability enhances its ability for remote control and monitoring.
- 2.1.8. Maintenance-free, sealed batteries minimize after-sales service.
- 2.1.9. The maintenance bypass switch provides an easy and safe troubleshooting or maintenance function when the utility is normal.
- 2.1.10. Providing four different working modes (Normal, ECO, CF50 and CF60) it may be used in a wide variety of applications.

- 2.1.11. The DC-start function ensures the start-up of the UPS during power outages.
- 2.1.12. A revolutionary battery management circuit analyzes battery discharging status to adjust the battery cut-off point and extend battery life.
- 2.1.13. The intelligent, temperature-controlled fan may not only extend the life of the fan but also reduce annoying noise because of sudden fan spin. This helps keep your office quiet and comfortable.
- 2.1.14. When the UPS is out of order you can read the possible reason from the LCD screen directly, which reduces unnecessary repairs.
- 2.1.15. When the UPS is operated in CF50 or CF60 mode, the recommended load connected shall be 75% of rated capacity if the input voltage is 176-280 VAC and 50% of rated capacity if the input voltage is 160-176 VAC and 25% of rated capacity if the input voltage is 110-160Vac.
- 2.1.16. Single input System Block

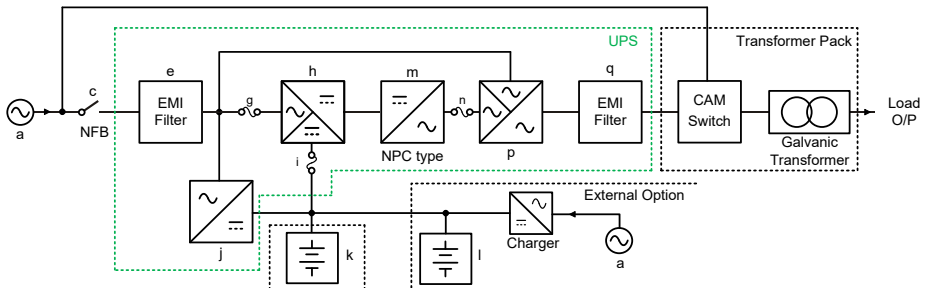



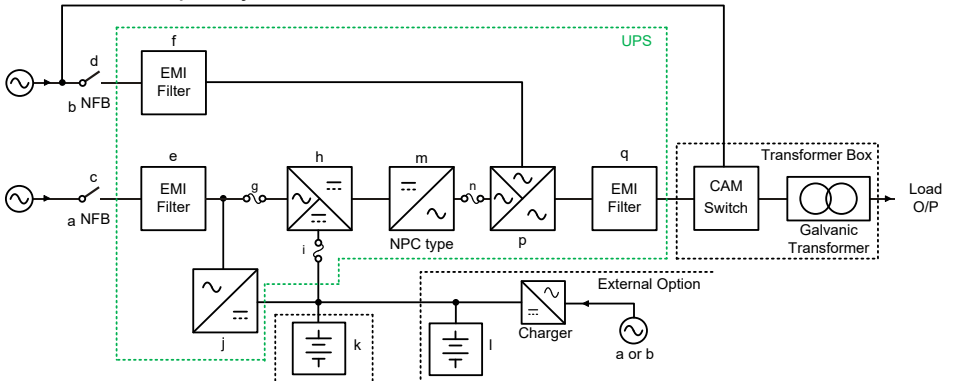











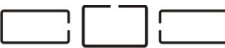



2.1.17. Dual input System Block



- a. UPS Utility Input: to provide the AC source to the UPS rectifier circuit and charger.
- b. UPS Bypass Input: to provide the AC source to the UPS Bypass Input and Maintenance Bypass loop.
- c. UPS Utility Input Breaker: to protect the UPS Rectifier circuit from over-current.
- d. UPS Bypass Input Breaker: to protect the UPS Bypass circuit from over-current.
- e. EMI Filter on UPS Utility Input : to eliminate the magnetic interference from AC Source or UPS Utility Input.
- f. EMI Filter on UPS Bypass Input: to eliminate the magnetic interference from AC Source or UPS Bypass Input.
- g. Fuse for UPS Utility Input: to provide over-current protection for UPS Rectifier Circuit.
- h. Rectifier and Booster: When Utility is normal, they will converts the AC to DC and correct input power factor. When Utility is abnormal, the batteries will be boosted to provide the DC voltage to the Inverter.
- i. Input fuse for Battery: to protect batteries when DC-Booster is out of order.
- j. Charger: the battery charging device.
- k. Internal Battery(6000C only): When AC abnormal, it provide the backup power from the batteries.
- l. External Battery Bank: To provide longer backup time by adding additional Battery bank.
- m. Inverter Generator: To convert the DC voltage to AC voltage
- n. UPS Inverter Output Fuse: When the UPS is overloaded, the fuse will be opened.
- o. Inverter Output Switch: When the UPS is overloaded or abnormal, or the UPS is working on ECO mode or if EPO (Emergency Power Off) is activated, the Switch will be opened.
- p. Auto Bypass Loop: When the UPS is overloaded or abnormal, the UPS will switch the UPS to bypass output automatically from inverter output.
- q. UPS Output EMI Filter: To eliminate the magnetic interference from the UPS Output and avoid the interference caused by the output load and the UPS.

2.2. Symbols on the LCD Display Panel

Item	Symbol	Description
1	INPUT	Utility or Bypass Source
2	Low ◀	Battery Low
3	Fault ◀	Battery Abnormal
4		UPS Overloading
5		UPS Working in specified mode*
6		Bypass Input Abnormal, UPS fails to transfer to bypass, Bypass Abnormal at ECO mode
7		Utility Input Abnormal
8	OFF	UPS Shutoff
9	INPUT OFF	UPS Abnormal Lock
10		UPS Flow Chart
11		3-Digit Measurement Display
12		Indicates the item to be measured
13		UPS ON Switch or Alarm Silence
14		UPS OFF Switch

15		Previous Page or Setting Change
16		Next Page
17		Special Function Log In/Out
18		Enter or Reconfirm
19		Utility Input Normal LED
20		Bypass Input Normal LED
21		UPS under Redundancy Mode
22		UPS under ECO Mode
23		UPS Fault or Abnormal Warning LED
24	EPO	Emergency Power Off
25	Er05	Battery Weak or Dead
26	Er06	Output Short Circuit
27	Er10	Inverter Over-current
28	Er11	The UPS is overheated.
29	Er12	UPS Output Overloading
30	Er14	Fan Error

31	Er15	Wrong Procedure to Enter Maintenance Mode
32	Er16	Output Parameters Set Error in Parallel System
33	Er17	ID Numbers are in conflict in Parallel System or ID number error in single unit
34	Er21	Parallel communication error (communication wire disconnected or failure to find ID1 UPS) in Parallel System
35	Er24	CVCF mode with Bypass input
36	Er27	The UPS must be operated in normal mode in Parallel System.
37	Er28	Bypass Overload Time out and cut off output
39	Er33	Isolated transformer is overheated.
40	Er**	Other Error code

**The specified modes include Normal mode, ECO mode, CVCF mode, etc..*

2.3. Panel Explanation

2.3.1. Front Panel

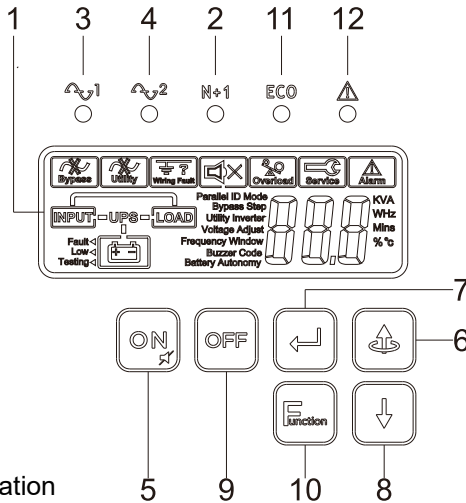

- ① LCD Information
- ② Green LED indicates that the UPS is able to run under redundancy mode.
- ③ Solid green LED indicates that the utility input voltage is within the window.
Flashing green LED indicates that the utility input voltage is outside the acceptable window.
- ④ Green LED indicates that Bypass Input is normal.
- ⑤ UPS ON/Alarm Silence
- ⑥ Go to previous page or change the setting of the UPS.
- ⑦ Confirm a changed setting.
- ⑧ Go to the next page.
- ⑨ UPS OFF Switch
- ⑩ Special functions log in/out
- ⑪ UPS is working under ECO (Economical) mode.
- ⑫ UPS Fault or Abnormal

2.3.2. Rear Panel

4.5KVA/ 6KVA

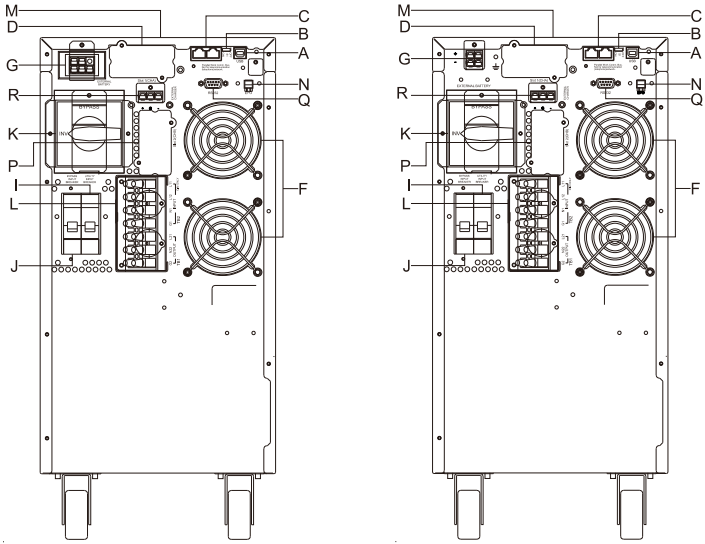

8KVA/10KVA

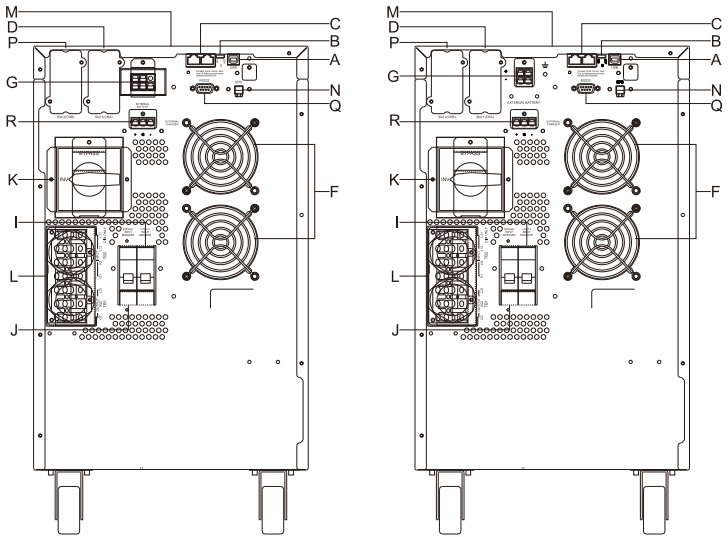

4.5KVA/ 6KVA WITH TRANSFORMER

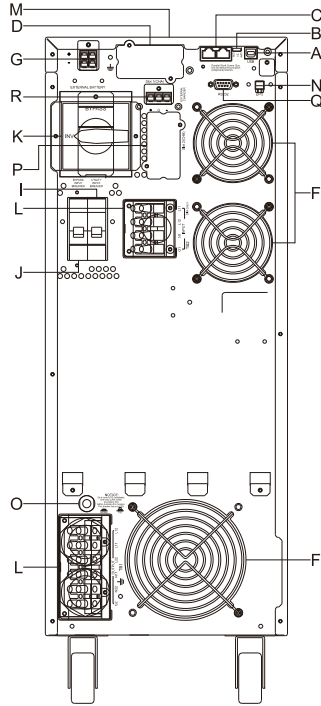
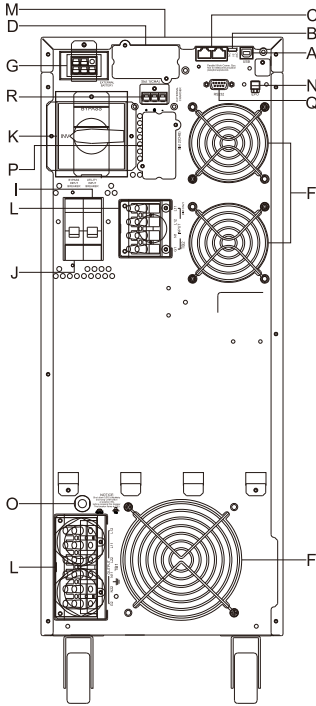

8KVA/10KVA WITH TRANSFORMER

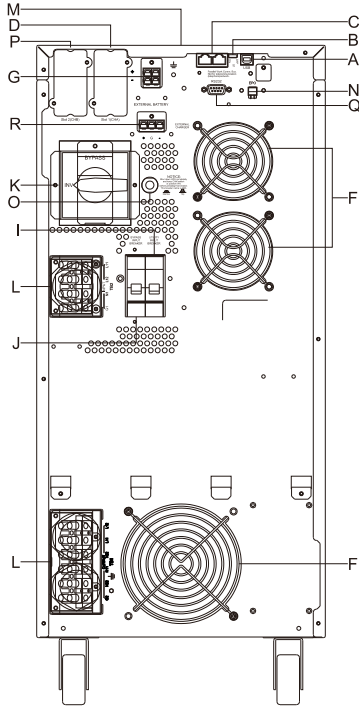
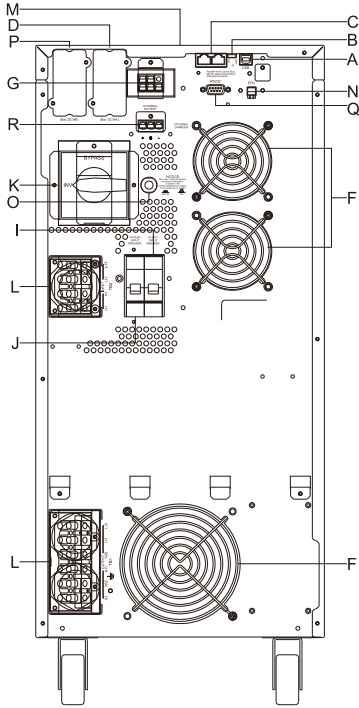

- A USB Port
- B Terminal Resistor for Parallel function (Optional)
- C CAN Bus Connection Port for Parallel System
(Do not for telecommunication network) (Optional)
- D Customer Options Slot 1
- E Outlet- IEC C19/C13 with Breaker
- F Cooling Fan
- G External Battery Connector
- H External Battery Ground
- I Utility Input Breaker CB1
- J Bypass Input Breaker CB2
- K CAM Switch (Maintenance Bypass Switch)
- L Input/output Terminal Block
- M Mounting Holes for External Charger Cabinet
- N EPO (Emergency Power Off) : 2 types switch state, Normal
Close and Normal Open
EPO can be converted to ROO(Remote ON/OFF)
ROO with 2 types switch state -Normal Close and Normal Open
ROO and EPO need to use the software switching
- O Thermal breaker for the protection of Load in abnormal condition:
CB3
- P Customer Options Slot 2
- Q RS232 port
- R External Charger Connector
- S AC output socket breaker

2.4. Communication Port

- 2.4.1. The communication port on the UPS provides for USB communication with the UPS software to remotely monitor the power and UPS status.
 - 2.4.1.1. You may use optional interfaces cards for R2E (RS-232), RSE (RS-485), USE (second USB), DCE (Dry Contact), and SNMP. However, the R2E card, RSE card and USE card must not be used simultaneously.
 - 2.4.1.2. The software bundled with the UPS is compatible with many operating systems such as Windows 2000, XP, Server 2003, VISTA, Server 2008, Win7 and Win8. For other applications such as Novell NetWare, Unix, or Linux please contact your local distributor for a proper solution.
 - 2.4.1.3. When the optional interface cards are used together with the onboard USB port the EPO signals will get highest priority, then the SNMP/WEB card, then the shutdown command at the DCE, R2E, RSE, and USE cards, and then finally the onboard USB port gets the lowest priority.
- 2.4.2. USB Definition:
- 2.4.2.1. complies with USB version 1.0,1.5 Mbps
 - 2.4.2.2. complies with USB HID version 1.0
 - 2.4.2.3. Pin Assignments:

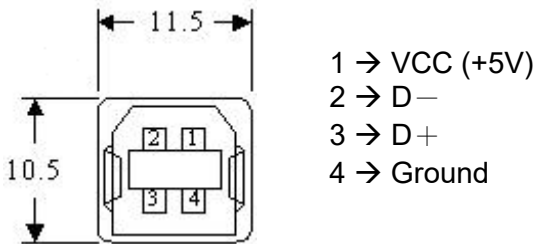

3. Installation and Operation

Carefully inspect the UPS for shipping damage before installation. Retain the packing material for future use.

3.1. Unpacking

3.1.1. Standard package contents:

- **User Manual**
- **Communication software with USB cable**
- **Metal Accessories Kit as below:**

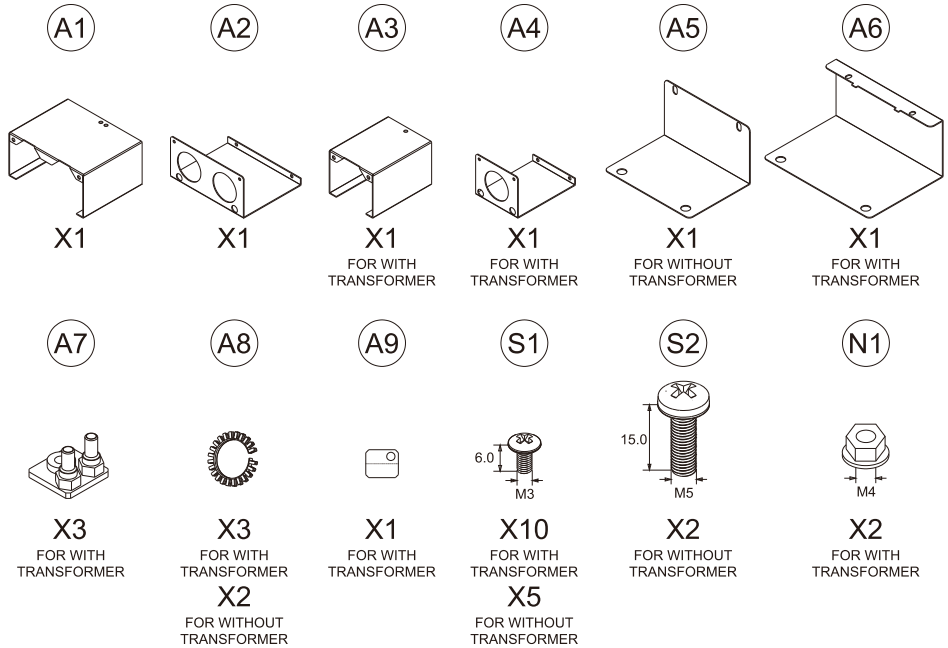

*A7 For different terminal type:

A7 kit small size(5RQ6000SBE01) for 4.5K/6K MODEL

A7 kit large size(5RQA000SBE01) for 8K/10K MODEL

3.2. Selecting Installation Position

Install the UPS in a proper environment to minimize the possibility of damage to the UPS and to extend the life of the UPS. Please follow these rules:

1. Keep at least 30 cm (12 inches) clearance from the rear panel of the UPS to the wall.
2. Do not block the air flow to the ventilation openings of the unit.
3. Ensure that the installation site is not excessively hot or moist.
4. Do not place the UPS in an environment near dust, corrosive or salty material, or flammable objects.
5. Do not expose the UPS to the outdoors.

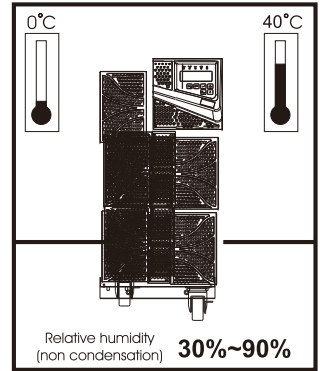
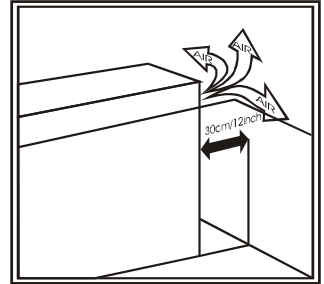

3.3. Installation of Accessories

WITHOUT TRANSFORMER

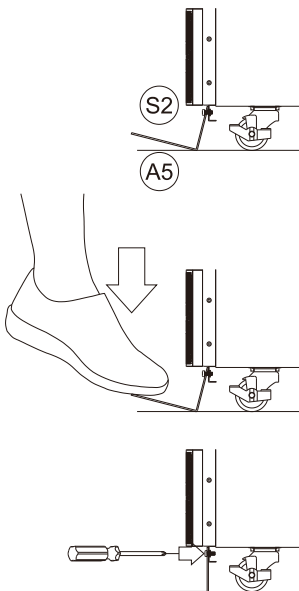

WITH TRANSFORMER

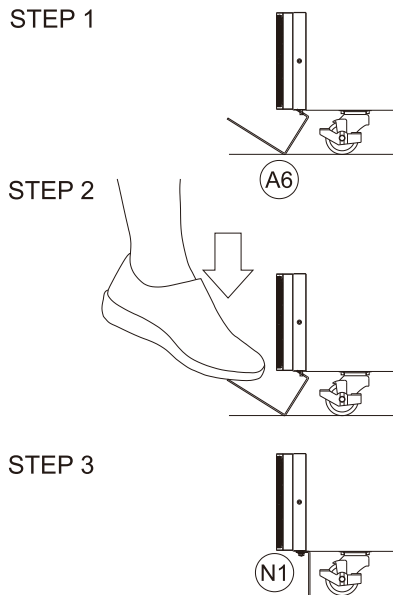

3.4. Terminal Block Explanation

4.5KVA/ 6KVA/ 8KVA/ 10KVA WITHOUT TRANSFORMER

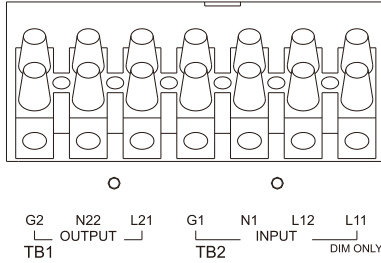

4.5KVA/ 6KVA/ 8KVA/ 10KVA WITH TRANSFORMER

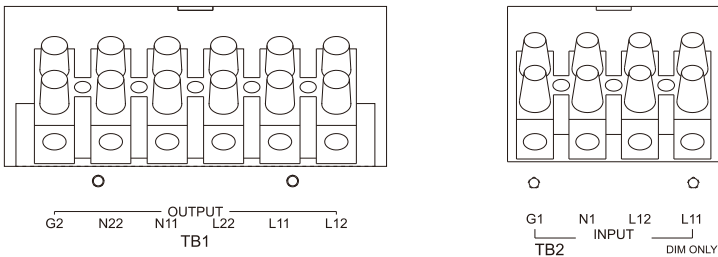

- **L11-N1**: the terminal for Bypass Input to provide the power source when the UPS is working under Bypass/ECO mode
- **L12-N1**: the terminal for Utility Input to provide the power source when the UPS is working under Normal mode
- **G1**: the terminal for UPS Input Ground
- **L21 \ N22**: the terminals for UPS Output
- **G2**: the terminal for UPS Output Ground
- A7 Kit short **L22-N11(TB1)**, applied to Output **L11-N22**: 240VAC or **L12-N22**:208VAC
- A7 Kit short **L11-L22(TB1)** and **N11-N22(TB1)**, Applied to Output A7(**L-N**):120VAC
- A7 Kit short Input **L11-L12(TB2)**: For Single Input application

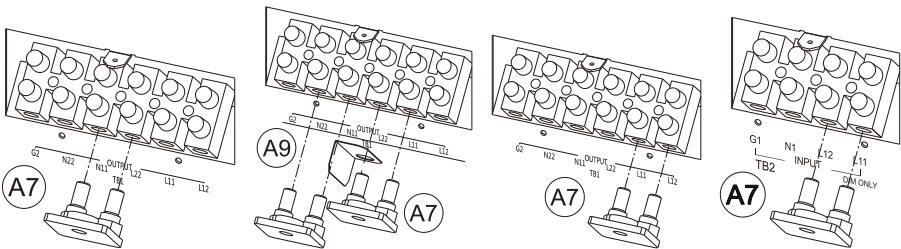

4.5KVA/ 6KVA/ 8KVA/ 10KVA WITH TRANSFORMER

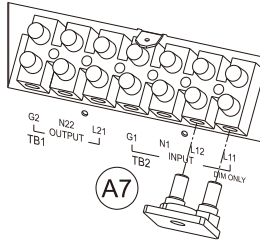

4.5KVA/ 6KVA/ 8KVA/ 10KVA WITHOUT TRANSFORMER

Remarks:

1. The maximum current for each terminal is 36 Arms for 4.5/6 kVA, 65 Arms for 8/10 kVA.
2. If the UPS is a SIM (Single Input) type, only AC source can be supplied to the UPS from the L12-N1 terminal for the Single-phase.
3. If the UPS is DIM (Dual Input Model) type but you want to use as Single Input Model, please add a cable bridge between Input L11 and L12
4. For output 120Vac application, output terminal N22 must use a wire of AWG #8 connect to ground.
5. Please refer to the specifications of input current, output current and recommended conductors listed below.

a. AC input and output

Model	Maximum Current	Conductor Section AWG (mm ²)
4.5KVA (Tower/RT)	25 A	AWG # 10 (5mm ²), 75°C
6KVA (Tower/RT)	36 A	AWG # 10 (5mm ²), 75°C
8KVA (Tower/RT)	50A _{in}	AWG # 6 (13mm ²), 90°C
	40A _{out}	AWG # 8 (8mm ²), 90°C
10KVA (Tower/RT)	62A _{in}	AWG # 4 (21mm ²), 90°C
	50A _{out}	AWG # 6 (13mm ²), 90°C

b. Battery input

Model	Maximum Current	Conductor Section AWG / (mm ²)
4.5KVA	19 A	AWG # 10 / 5mm ²
6KVA	36 A	AWG # 10 / 5mm ²
8KVA	42 A	AWG # 10 / 5mm ²
10KVA	53 A	AWG # 8 / 8mm ²

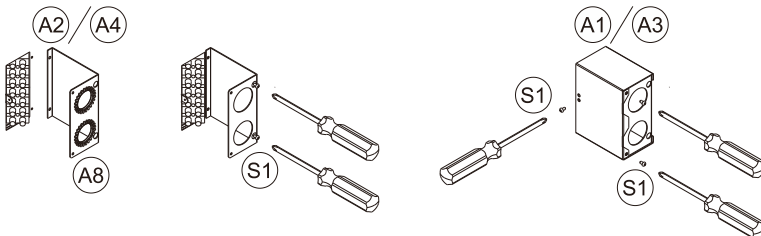

3.5. Installation and Operation

3.5.1. Start Up in Normal Mode

- 3.5.1.1. Open the terminal block cover on the rear panel. (Refer to 2.3.2.) Before starting the installation make sure the grounding is connected properly.
- 3.5.1.2. Make sure the utility breaker and the UPS' Utility breaker and Bypass breaker are in the "Off" position.
- 3.5.1.3. Make sure the utility voltage matches the input voltage window of the UPS.
- 3.5.1.4. Connect the utility separately to the terminal blocks of the UPS' Utility and Bypass inputs. Switch on the power breaker of the distribution panel and the breakers of the UPS' Utility and Bypass inputs. Then the UPS will start up. Green LEDs ≈ 1 and ≈ 2 show that the Utility and Bypass inputs are normal. UPSs with parallel function enabled will display first figure A1, then figure A2, and then figure B. Otherwise the LCD will display figure A1 directly followed by figure B.

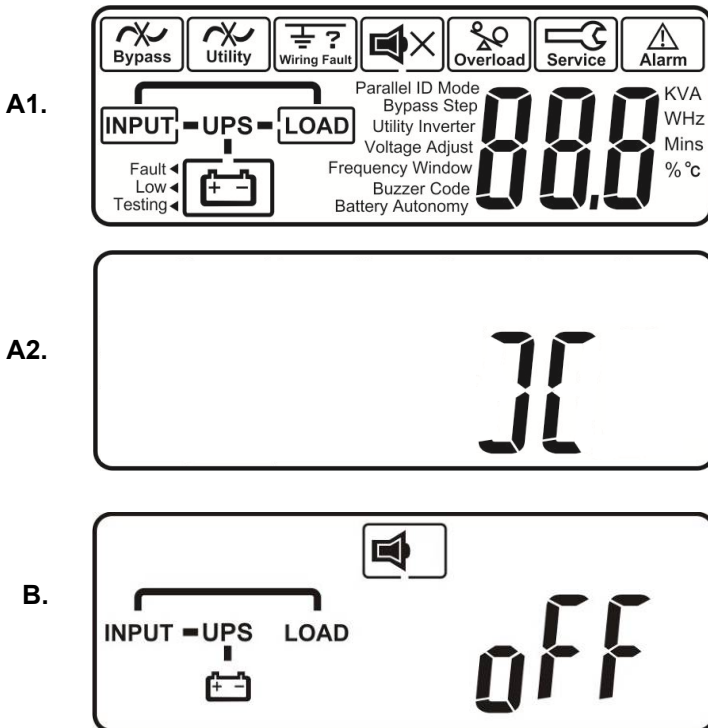

- 3.5.1.5. The UPS is in Bypass Mode now. It will proceed to self-test automatically. If no abnormal message appears then the pre-startup of the UPS was successful and the charger starts to charge the batteries.
- 3.5.1.6. Press the UPS On Switch  for approximately three seconds. The Buzzer sounds twice and the LCD display changes from figure B to figure C.

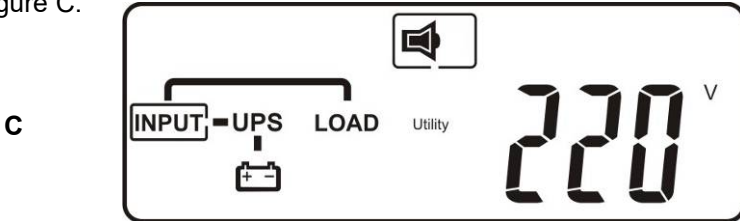

- 3.5.1.7. The UPS is in self-test mode again. The LCD display will change from figure C to figure D, and the UPS will remain in battery mode for approximately four seconds. Then the display will change from figure E1 to figure F if the self-test was successful.

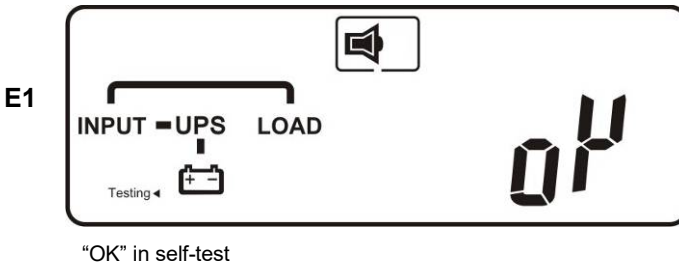
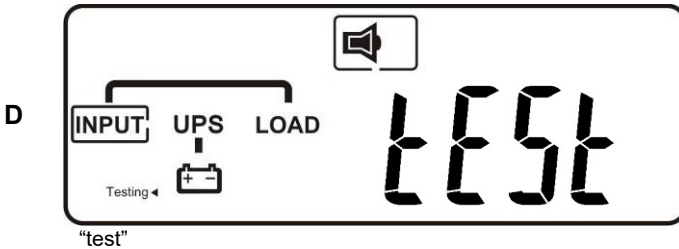

E2

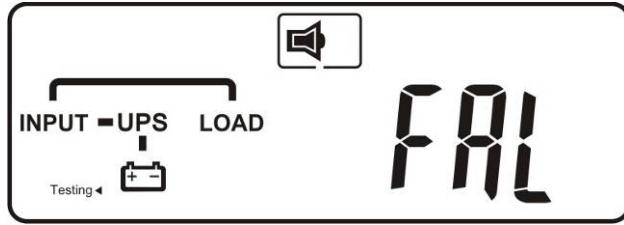

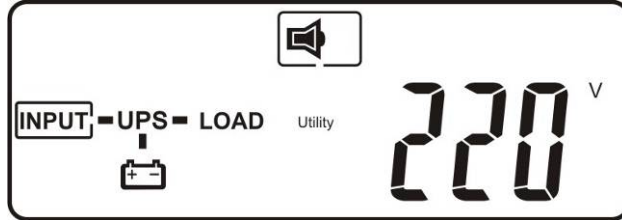

“Fail” in self-test

F



“220 VAC” in Utility Input

- 3.5.1.8. If the self-test fails the LCD display will change from figure D to figure E2. Then an error code or error status will appear on the screen.
- 3.5.1.9. Start-up operation of the UPS is complete now. Make sure the UPS is plugged into the wall receptacle for charging at least 8 hours and the batteries are fully charged before connecting the device to be protected.
- 3.5.2. Start-up in Battery Mode (Cold Start)
 - 3.5.2.1. Make sure the UPS has at least one set (12-16 pcs for RT 4.5k/6k, 6000C ; 16/20 pcs for RT 8k/10k) of 12V/7AH batteries.
 - 3.5.2.2. Push the UPS On Switch  once for approximately 5 seconds to awaken the UPS. The buzzer will sound twice. The LCD display will change from figure A to figure G for approximately 15 seconds.
 - 3.5.2.3. Press the UPS On Switch  again for about three seconds until the LCD display changes from figure G to figure H. Then the UPS will be in self-test mode. The UPS may offer energy to the output in a minute, and the LCD displays figure I. In case of failure in pushing the UPS On Switch for 15 seconds, the UPS will automatically turn off. You must then repeat steps [3.5.2.1](#) to [3.5.2.3](#).

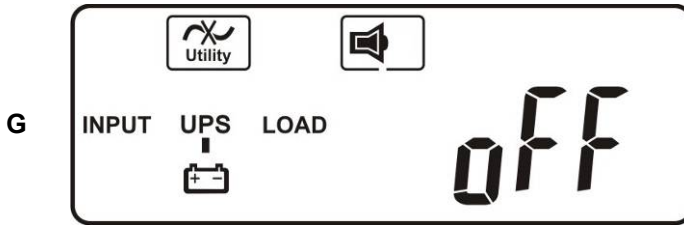

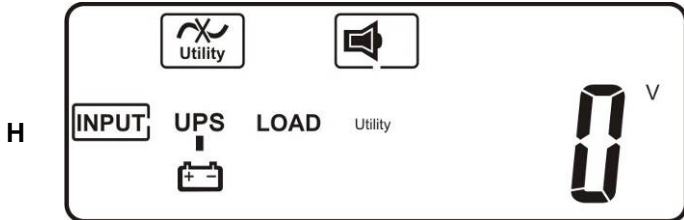

“Off”, which means the UPS pre-start was successful

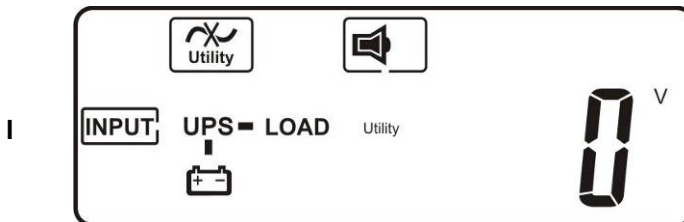

Utility input is “0” and Utility Abnormal.



3.5.3. Check Measured Values and Figures detected by the UPS

- 3.5.3.1. If you would like to check the measured values and figures detected by the UPS use the scroll up  and scroll down  keys. When you scroll down the LCD will display figure C (Voltage from Utility Input) → figure I1 (Voltage from Bypass Input) → figure J (Frequency from Utility Input) → figure K (Frequency from Bypass Input) → figure L (UPS Output Voltage) → figure M (UPS Output Frequency) → figure N (UPS Output Load %) → figure O1 (UPS Battery Voltage) → O2 (UPS Battery Numbers) → figure P (UPS Inner Temperature).

I1

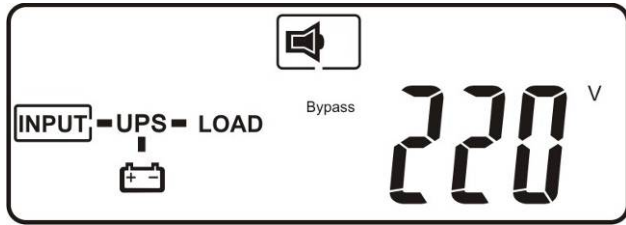

Voltage comes from Bypass Input.

J

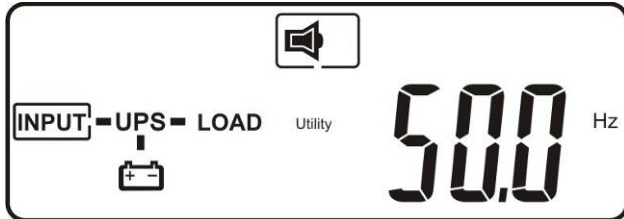

Frequency of Utility Input

K

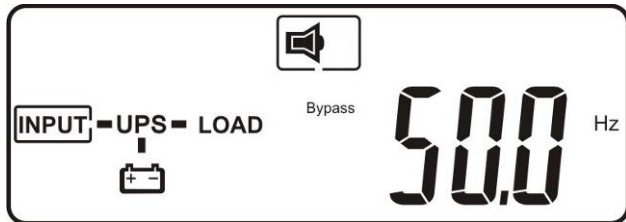

Frequency of Bypass Input

L

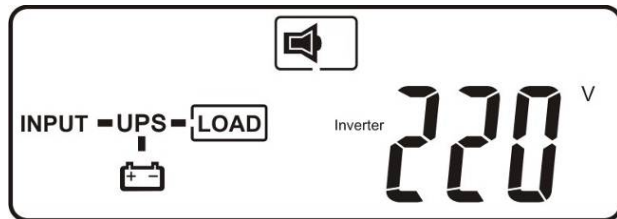

UPS output voltage

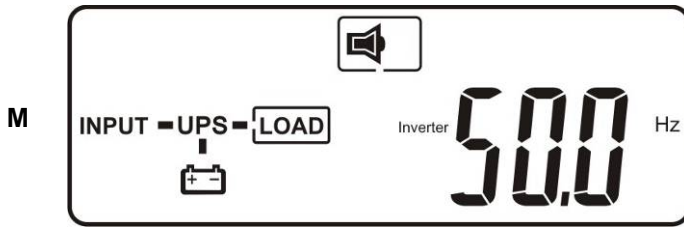

output frequency

UPS

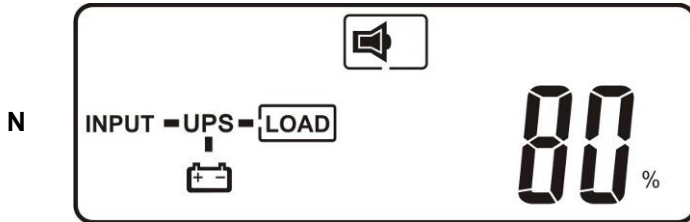

UPS output load level (%)

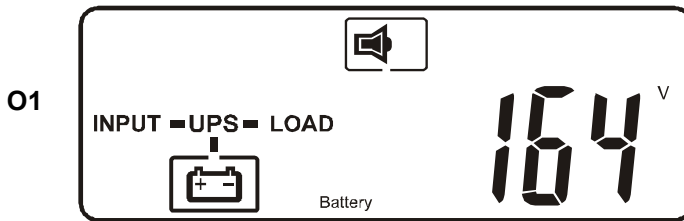

UPS battery voltage

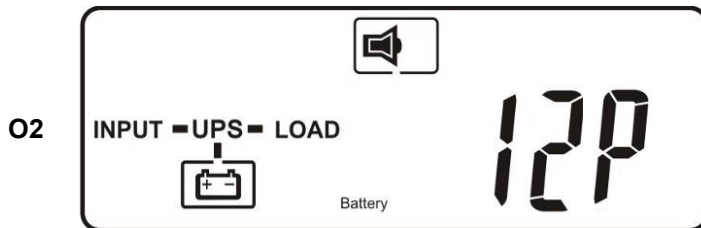

UPS battery numbers

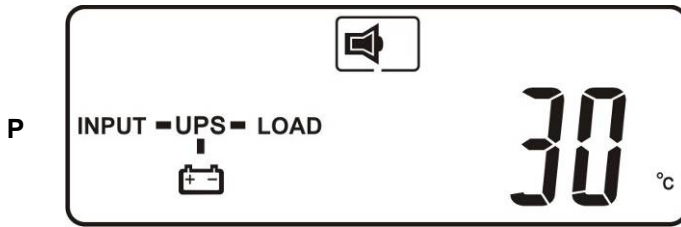

UPS inner temperature

3.5.4. UPS Default Data and Special Function Execution

3.5.4.1. After the UPS completely starts up, press the  key to change the LCD display to figure Q1.

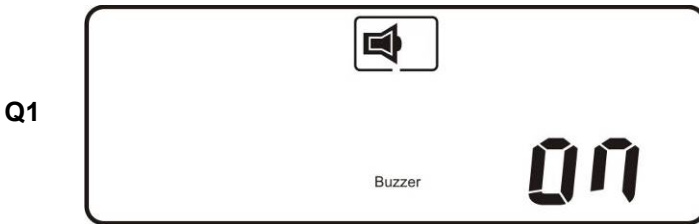

buzzer "On"

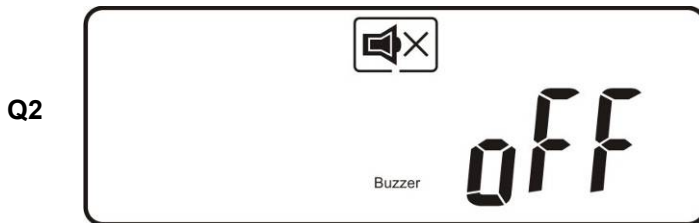

buzzer "Off"

3.5.4.2. Press the  key to scroll through the UPS settings. The LCD will display in sequence figure Q1 (buzzer) → figure R1 (Self-test) → figure S1 (Bypass Voltage Windows) → figure T (Output Frequency Synchronization Window) → figure U (Inverter Output Voltage) → figure V1 (UPS Operation Mode) → figure W (Output Voltage Micro Tune Value) → figure X (UPS Id) → figure Y (Parallel function status) → figure Z (Battery cabinet/capacity setting).

R1



Testing ◀

off

Self-test is not "On".

R2



Testing ◀

on

Self-test is "On".

S1



Bypass
Voltage
Window

Lo

Bypass Voltage is adjusted to wide range.

S2



Bypass
Voltage
Window

Hi

Bypass Voltage is adjusted to narrow range.

T



Bypass
Frequency Window

03 Hz

Frequency Window is ± 3 Hz.

U

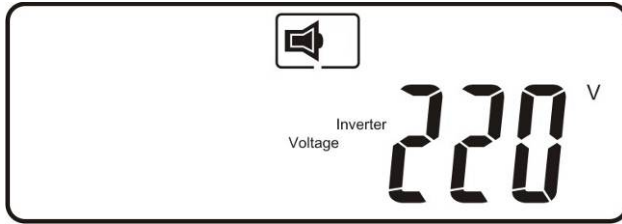

inverter output voltage

V1

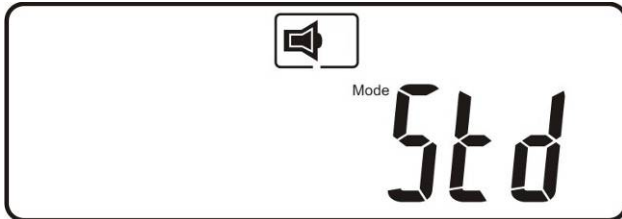

UPS is operating in "normal mode".

The

V2

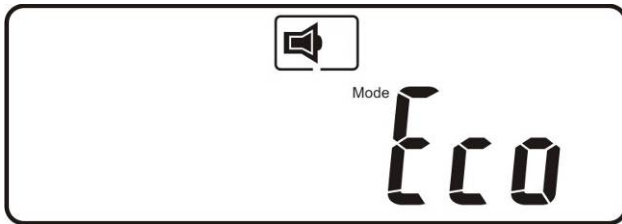

UPS is operating in "Eco mode".

The

V3

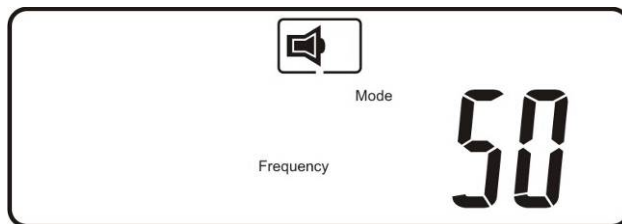

The UPS is operating in "CVCF 50 Hz mode".

V4

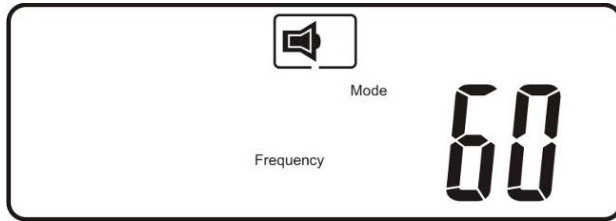

The UPS is operating in "CVCF 60 Hz mode".

W

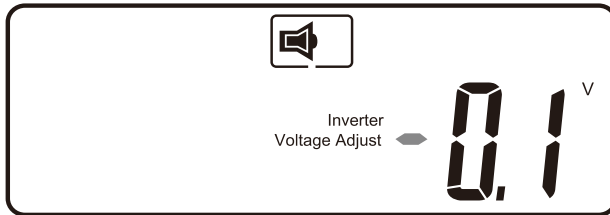

Output Voltage Adjustment ($\pm 6.0V, 0.1V/\text{Per-scale}$)

X

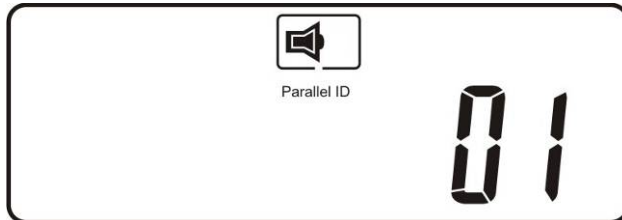



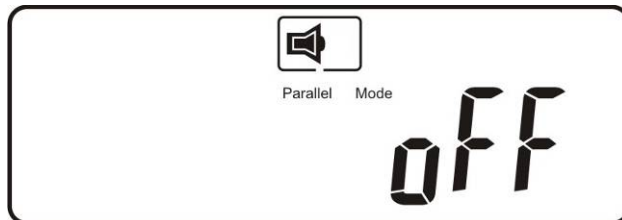

UPS position in parallel mode

Y



The parallel function is disabled.

- 3.5.4.3. Press the scroll up  key to execute special functions. The functions include buzzer ON (as in figure Q1), buzzer OFF (as in figure Q2, Alarm silence for UPS Warning), and self-test OFF (as in figure R1) or self-test ON (as in figure R2). The UPS will execute the battery test for ten seconds. If the self-test is successful it will display figure E1; otherwise, it will display figure E2 and an error message at the same time.)
- 3.5.5. UPS Default Settings and their alternatives
- 3.5.5.1. Make sure the UPS is not “On”. Press the On  and scroll down  keys simultaneously for approximately three seconds. The buzzer will sound twice, and the LCD will display figure Q1, indicating that the UPS is in setting mode.
- 3.5.5.2. To scroll through the options refer to section 3.5.4.2.
- 3.5.5.3. Except for Buzzer (figures Q1 and Q2) and Self-test (figures R1 and R2) all of the other default settings may be changed by pressing the scroll up  key.
- 3.5.5.4. Figures S1 and S2 indicate the bypass input acceptable window. It follows the inverter output voltage. Please refer specification for the detail.
- 3.5.5.5. Figure T indicates the bypass frequency window of the Inverter Output. The acceptable setting values are ± 3 Hz and ± 1 Hz.
- 3.5.5.6. Figure U indicates the acceptable Inverter Output Voltage. Possible values are 200, 208, 220, 230, or 240 VAC.
- 3.5.5.7. Figures V1, V2, V3 and V4 indicate the operation modes of the UPS. Possible values are Online, Eco (Economical) mode, fixed 50 Hz Output, and fixed 60 Hz Output.
- 3.5.5.8. Figure W indicates the fine tune range of inverter voltage which can be set from -6V to +6V of rating voltage. (The minimum adjustable scale is 0.1V).
- 3.5.5.9. Figure X indicates the position of the UPS when the UPS is in Parallel mode. Possible positions are 1, 2, 3, and 4. The position must be 1 if the UPS is not in Parallel mode.
- 3.5.5.10. Figure Y indicates the parallel function status. “OFF” and “ON” separately indicate disabled and enabled.
- 3.5.5.11. Figure Z indicates the last page of settable parameters.
- 3.5.5.12. After changing settings, you must press the enter  key to save all of your changes and exit the setting mode. Then the LCD will display figure AA, figure A1, then figure A2, and then figure B.

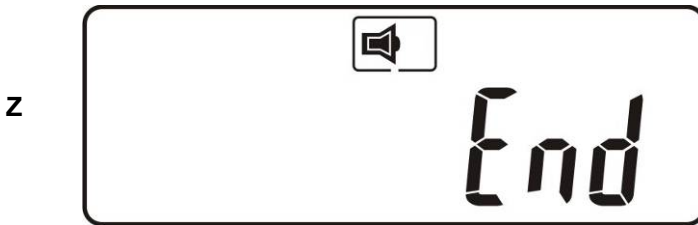

* Press the Enter key to save changes.

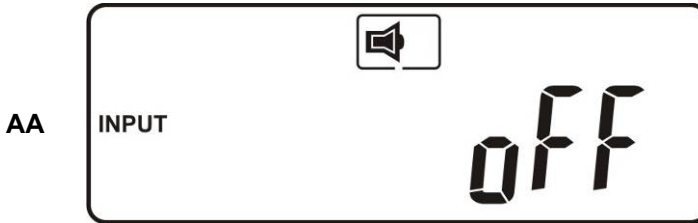

The UPS is locked.









3.5.5.13. Turn Off the Utility Input breaker.

3.5.5.14. Your setting changes are now complete.

3.5.6. Troubleshooting when the UPS is Off Due to Unknown Reasons

3.5.6.1. If there is a serious abnormal condition the UPS will lock itself in the "OFF" position as shown in figure AB, and an "abnormal" message will appear on the LCD.

3.5.6.1.1. After three seconds all messages will be locked except both

Bypass messages (LED  and LCD ) and Utility messages (LED  and LCD ). If the Bypass or Utility is abnormal after the UPS is locked, the related LED  or  will be extinguished and also the related LCD symbol  or  will appear.

3.5.6.2. To release the UPS lock proceed as follows:

3.5.6.2.1. Check the recorded error messages.

3.5.6.2.2. Check the error messages in section 2.2 to help troubleshoot the problem. For further help consult your local distributor.

3.5.6.2.3. Press the Off  key for five seconds. A buzzer will sound twice.



3.5.6.2.4. Turn Off the Utility Input breaker.

3.5.6.2.5. Even if the UPS lock problem is solved now, consult with your local distributor to make sure that the error condition is resolved.

3.5.7. Shut Off

- 3.5.7.1. Press the Off  key for five seconds. The Inverter output will be turned off, and the output load will be supplied by the Bypass loop. The LCD will display figure B.
- 3.5.7.2. Turn Off the Utility and Bypass Input breakers.
- 3.5.7.3. The UPS is now turned off completely.

3.5.8. Maintenance Bypass Mode

- 3.5.8.1. Maintenance Bypass Mode is for UPS maintenance only. Only authorized technicians are allowed to perform the following procedures. If there is any damage during unauthorized execution of these procedures your warranty will be void immediately.
 - 3.5.8.1.1. Press the Off  key for approximately five seconds. The LCD will display figure B, and the UPS output will be in bypass mode.
 - 3.5.8.1.2. Remove the cover of the CAM Switch (Maintenance Bypass Switch), then turn on the CAM Switch to “Bypass” mode. In the upper right-hand corner of the LCD a  sign will appear.
 - 3.5.8.1.3. Turn off the UPS Utility breaker as well as the Bypass Input Breaker. You may proceed with UPS maintenance now.
 - 3.5.8.1.4. When you are done with UPS maintenance put the UPS back into normal working mode as explained in section 3.5.1.4. Then return the CAM switch to “INV” mode, replace the cover, and repeat sections 3.5.1.5 to 3.5.1.8. The UPS will switch back to inverter mode.
 - 3.5.8.1.5. You must perform section 3.5.8.1.1 before section 3.5.8.1.2. If you skip section 3.5.8.1.1 the UPS will alert for ten seconds to warn that the procedure is abnormal and may damage the UPS due to uncertain utility status. The UPS will switch back to Inverter mode immediately if you turn the CAM switch back to “INV”.

4. Troubleshooting Guide

4.1. Troubleshooting

If the UPS malfunctions during operation first check the following:

- a. Is the input and output wiring correct?
- b. Is the input voltage of the utility within the input window of the UPS?

If problems still exist check the following for proper adjustment. Should the problem still persist, please contact your local distributor for help.

Situation	Check Items	Solution
Red Fault LED	<p>Check the error code shown on the LCD.</p> <p>1. Er05, Low ◀ & Fault ◀</p> <p>2. Er06, Er10, Er12 Er28 & </p> <p>3. EPO</p> <p>4. Er11, Er33</p> <p>5. Er14</p> <p>6. Er15</p> <p>7. Er16, Er17, Er27</p> <p>8. Er21</p> <p>9. Er24</p> <p>10. other error code</p>	<p>1. Check for proper battery connection, then recharge the batteries for 8 hours to see whether the UPS provides backup power normally; otherwise, consult your local distributor right away.</p> <p>2. If CB3 is tripped, turn off the UPS completely and keep the CAM switch at position INV before pressing CB3. Then remove some uncritical load at the UPS output end. If there is any damage to the insulation of the AC power cord, please replace it with a new one.</p> <p>3. Remove the short circuit at the EPO terminal.</p> <p>4. Remove any objects blocking the ventilation holes.</p> <p>5. Check that the cooling fans on the rear panel are working normally.</p> <p>6. Make sure the UPS is operated normally. If it is in CVCF mode you must turn off and turn on the UPS again.</p> <p>7. All of the parameters except ID Number in a parallel UPS must be the same. Please refer to section 3.5.5 to set them again.</p> <p>8. Disconnect and reconnect the RJ45 connector or set a UPS with ID=1.</p> <p>9. When the UPS is in CVCF mode it is prohibited from having bypass input. You must turn off the UPS and bypass input and then restart the UPS.</p> <p>10. Consult your local distributor for help.</p>

<p>UPS fails to offer battery backup or its backup power time is shorter than calculated.</p>		<p>If the backup power time is still too short after 8 hours of charging please contact your local distributor for battery replacement.</p>
<p>UPS locks itself and can not be turned off.</p>		<p>Refer to section 3.5.6 to troubleshoot the problem; otherwise, consult your local distributor for help.</p>

4.2. Battery Replacement

4.5/6KVA without Transformer

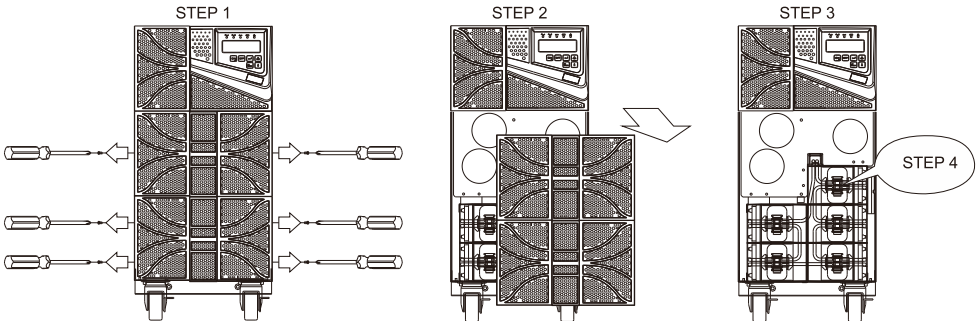

8/10KVA without Transformer

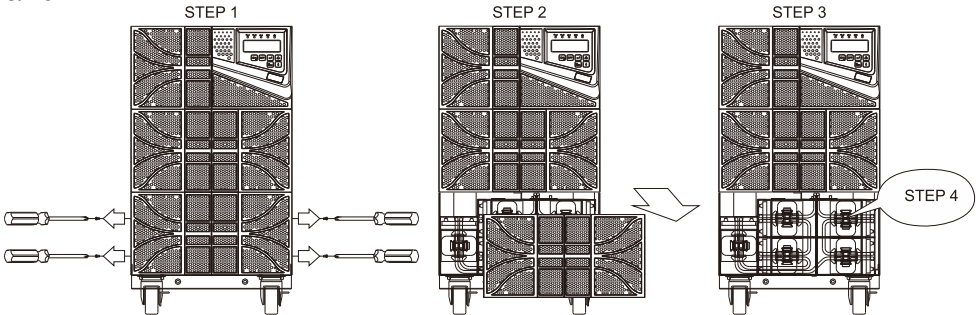

4.5/6KVA with Transformer

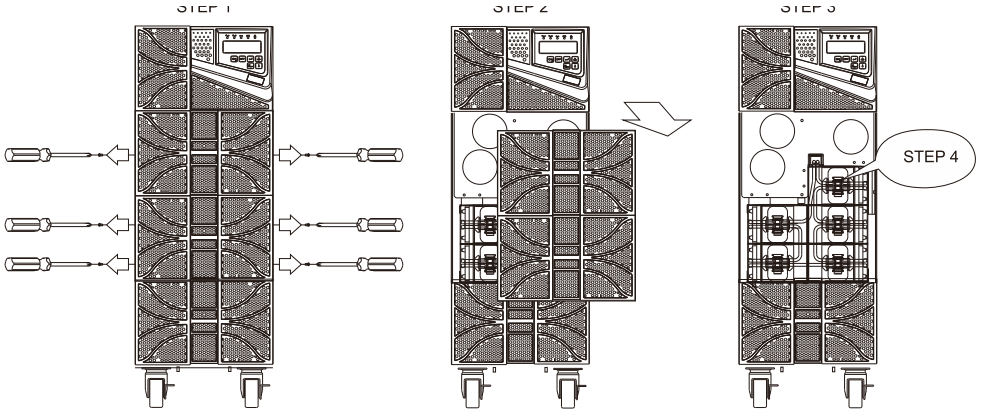

8/10KVA with Transformer

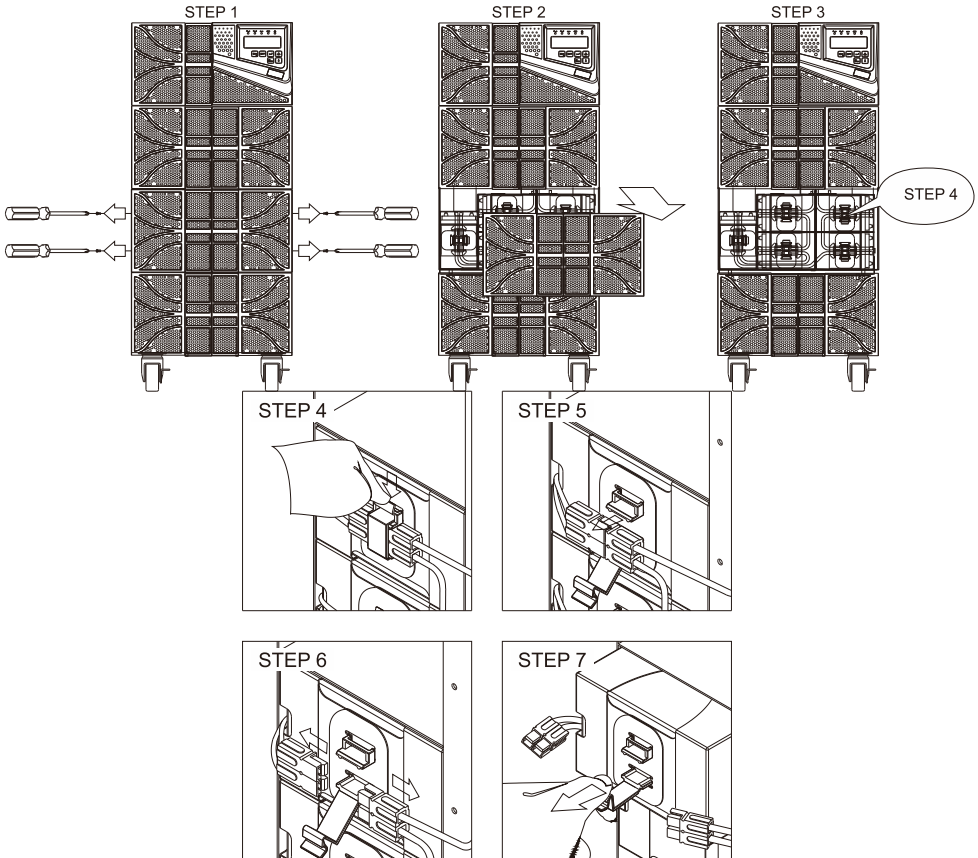

5. Communication Software

5.1. *Hardware Setup*

1. Connect the male connector of the USB cable to the UPS communication port.
2. Connect the female connector of the USB cable to a dedicated USB port of the attached computer.
3. For optional interface cards refer to Chapter 6 for installation.

5.2. *Software Installation*

Please refer to the software user's manual.

6. Optional Interface Cards

6.1. R2E (RS-232) card

6.1.1. CN1 is for RS-232 DB9.

6.1.2. Definition

6.1.2.1. Interface Settings

The RS-232 interface shall be set as follows:

Baud Rate	2400 to 9600 bps
Data Length	8 bits
Stop Bit	1 bit
Parity	None



6.1.2.2. Pin Assignments

The Pin Assignments of true RS-232 are as follows (The connector is male.):



Pin 3: RS-232 Rx
 Pin 2: RS-232 Tx
 Pin 5: Ground

6.2. RSE (RS-485) card

6.2.1. CN1 is for the terminal-resistor function. Short pins 1-2 to enable the function. Short pins 2-3 to disable it.

6.2.2. CN2 is for RS-485. CN3 is for remote power.

6.2.3. Definition:



6.2.4. Installation Position: slot 1

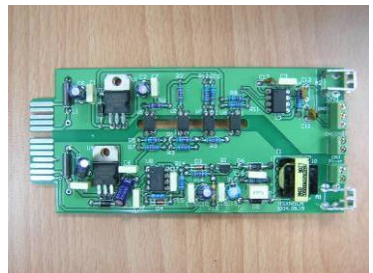

6.3. DCE (Dry Contact)-B card

6.3.1. pin assignments of 10-pin terminal:

1	2	3	4	5	6	7	8	9	10
---	---	---	---	---	---	---	---	---	----

- Pin 1: UPS on Bypass mode
- Pin 2: Utility Abnormal
- Pin 3: Utility Normal
- Pin 4: Inverter On
- Pin 5: Battery Low
- Pin 6: Battery Bad or Abnormal
- Pin 7: UPS Alarm
- Pin 8: Common
- Pin 9: Shutdown UPS positive (+) signal
- Pin 10: Shutdown UPS negative (-) signal

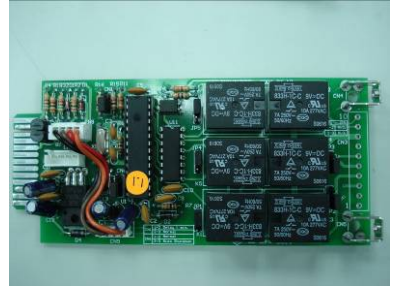

- 6.3.2. The shutdown function will be activated after +6~+25 VDC is applied between pin 9 and pin 10 for 5 seconds.
- 6.3.3. The capacity of each relay contact is 40 VDC/25mA.
- 6.3.4. Installation Position: slot 1 (CHA-CN7) or slot 2 (CHB-CN8)
- 6.3.5. Flexible signal output for N.C. (Normal close) or N.O. (Normal open) contact by shorting pins 1-2 or pins 2-3 from JP1-5
- 6.3.6. The shutdown function will be enabled 1 minute after blackout occurs if pins 1-2 of both CN1 and CN6 are shorted. Otherwise the shutdown function can be enabled only by pins 9-10 of CN3 if pins 2-3 of both CN1 and CN6 are shorted. (Refer to [6.3.2.](#))

6.4. DCE (Dry Contact)-C card

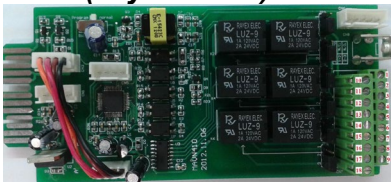

- 6.4.1. Please refer to the New Dry Contact Card English Installation Guide (A5)-192321002014002.

6.5. SNMP Card

6.5.1. SNMP/Web card

6.5.1.1. For installation please refer to the card's user manual.

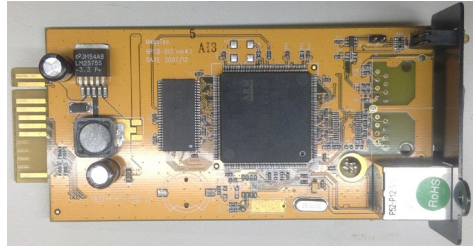

6.6. Interface Card Installation

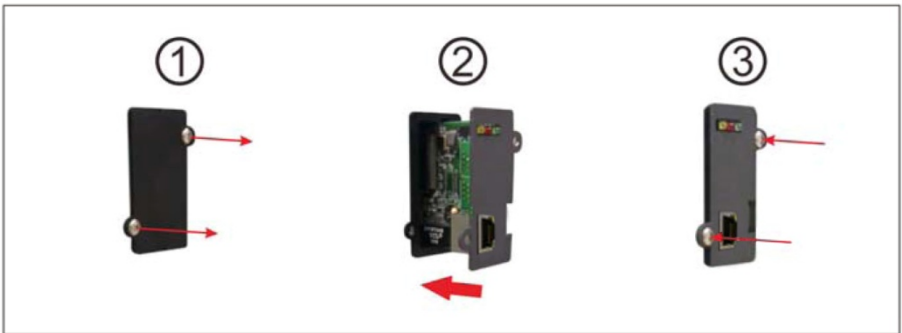

7. Specifications - 4.5kVA/6kVA

Rating Capacity(kVA/kW)	4.5kVA		6kVA	
INPUT				
Voltage Range (With derating range)	110 ~ 280 V _{AC} (1Φ)			
	De-rating 50% Capacity	110 - 160Vac		
	De-rating 75% Capacity	160 - 176Vac		
	100% Load Capacity	176 - 280Vac		
Frequency	45 ~ 70 Hz			
Phase/Wire	Single-in, Line + Neutral + Ground			
Power Factor	Up to 0.99 at 100% Linear Load			
Current THD (100% linear load)	< 5%			
OUTPUT				
Voltage Window	200/ 208/ 220/ 230/ 240 V _{AC} Selectable			
Frequency Regulation	±1Hz, ±3Hz Selectable			
Voltage Regulation	100% Linear Load	w/o TX	±1%	
		w/ TX	±3%	
Capacity	4500 VA		6000 VA	
Rated Power Factor	1.0			
Sine Waveform Distortion	100% Liner Load	w/o TX	<2%	
		w/ TX	<2%	
	100% Non-Liner Load	w/o TX	<7%	
		w/ TX	<9%	
Frequency Stability	<0.2% (Free Running)			
Transfer Time	0 ms			
Crest Factor	3:1 Acceptable			
Efficiency (AC to AC, Normal)	Up to 93%			
Efficiency (AC to AC, ECO)	Up to 98%			
DC Start	Yes			
Bypass Voltage Windows	Low: ±15% High: ±10%	Inv.	Range	
			240V	L
		H		264~216±5Vac
		230V	L	264.5~195.5±5 Vac
			H	253~207±5Vac
		220V	L	253~187±5Vac
			H	242~198±5Vac
		208V	L	239.2~176.8±5

			Vac
		H	228.8~187.2±5 Vac
	200V	L	230~170±5Vac
		H	220~180±5Vac

BATTERY BANK

Type: Sealed Lead Acid Maintenance Free	7Ah/9Ah
Series Quantity	12/14/16/18/20pcs(Default), ^{Note1}
Voltage	144/168/192/216/240 Vdc
Recharge Time	4 hours to 90%

DISPLAY

Status On LED + LCD	Line Mode, Backup Mode, ECO Mode, Bypass Supply, Battery Low, Battery Bad/Disconnect, Overload, Transferring with interruption, UPS Fault
Readings on LCD	Input Voltage, Input Frequency, Output Voltage, Output Frequency, Load Percentage, Battery Voltage, Inner Temperature.
Self-Diagnostics	Front Panel Setting & Software Control, Upon Power-on, 24-hour routine checking

ALARMS

Audible and Visual	Line Failure, Battery Low, Transfer to Bypass, System Fault Conditions
--------------------	---------------------------------------------------------------------------

PHYSICAL

Dimensions W x D x H(mm)	without transformer	240x700x513	
	With transformer	240x700x661	
Input/output Connection		Hard-wired	
External Battery Connection		Plug-in & Play	
Net weight (kg), With battery 9AH 2.6kg x 20	without transformer	78 kg	
	With transformer	121 kg	
Heat Dissipation	Without Isolated Transformer at full Linear Load	< 400W	<600W
	Tower model (with	< 750 W	<1000W

	Isolated Transformer at Full Linear Load)		
Leakage Current	< 3 mA at Full Load		
Quality Assurance	ISO9001 Certified Company		
Safety Standard	EN62040-1 UL1778		
EMC Standard	IEC/EN 62040-2 FCC Part15 class A		
Marks	CE(1P/1P) cULus (1P/1P)		

Note1: PS: the power output will reduce when the battery less than 16pcs.

8. Specifications - 8kVA/10kVA

Rating Capacity(kVA/kW)	8kVA	10kVA		
INPUT				
Voltage Range (With derating range)	110 ~ 280 V _{AC} (1Φ)			
	De-rating 50% Capacity	110 - 160Vac		
	De-rating 75% Capacity	160 - 176Vac		
	100% Load Capacity	176 - 280Vac		
Frequency	45 ~ 70 Hz			
Phase/Wire	Single-in, Line + Neutral + Ground			
Power Factor	Up to 0.99 at 100% Linear Load			
Current THD (100% linear load)	<5%			
OUTPUT				
Voltage Window	200/ 208/ 220/ 230/ 240 V _{AC} Selectable			
Frequency Regulation	±1Hz, ±3Hz Selectable			
Voltage Regulation	100% Linear Load	w/o TX ±1%		
		w/ TX ±3%		
Capacity	8000 VA	10000 VA		
Rated Power Factor	1.0			
Sine Waveform Distortion	100% Liner Load	w/o TX <2%		
		w/ TX <3%		
	100% Non-Liner Load	w/o TX <7%		
		w/ TX <9%		
Frequency Stability	<0.2% (Free Running)			
Transfer Time	0 ms			
Crest Factor	3:1 Acceptable			
Efficiency (AC to AC, Normal)	Up to 94%			
Efficiency (AC to AC, ECO)	Up to 98%			
DC Start	Yes			
Bypass Voltage Windows	Low: ±15% High: ±10%	Inv.	Range	
		240 V	L	276~204±5Vac
			H	264~216±5Vac
		230 V	L	264.5~195.5±5Vac
			H	253~207±5Vac
		220 V	L	253~187±5Vac
			H	242~198±5Vac
		208 V	L	239.2~176.8±5Vac

		V	H	228.8~187.2±5Vac
		200	L	230~170±5Vac
		V	H	220~180±5Vac
BATTERY BANK				
Type: Sealed Lead Acid Maintenance Free	7Ah/9Ah			
Series Quantity	16/18 /20pcs (Default) ^{Note1}			
Voltage	192/216/240 Vdc			
Recharge Time	4 hours to 90%			
DISPLAY				
Status On LED + LCD	Line Mode, Backup Mode, ECO Mode, Bypass Supply, Battery Low, Battery Bad/Disconnect, Overload, Transferring with interruption, UPS Fault			
Readings on LCD	Input Voltage, Input Frequency, Output Voltage, Output Frequency, Load Percentage, Battery Voltage, Inner Temperature.			
Self-Diagnostics	Front Panel Setting & Software Control, Upon Power-on, 24-hour routine checking			
ALARMS				
Audible and Visual	Line Failure, Battery Low, Transfer to Bypass, System Fault Conditions			
PHYSICAL				
Dimensions W x D x H(mm)	without transformer	288x700x513		
	With transformer	288x700x661		
Input/output Connection		Hard-wired		
External Battery Connection		Plug-in & Play		
Net weight (kg), With battery 9AH 2.6kg x 20	without transformer	93 Kg		
	With transformer	135 Kg		
Heat Dissipation	Without Isolated Transformer at full Linear Load	< 650 W	<800W	
	Tower model (with Isolated Transformer	< 1200 W	<1400W	

	at Full Linear Load)		
Leakage Current		< 3 mA at Full Load	
Quality Assurance		ISO9001 Certified Company	
Safety Standard		EN62040-1 UL1778	
EMC Standard		IEC/EN 62040-2 FCC Part15 class A	
Marks		CE(1P/1P) cULus (1P/1P)	

Note1: PS: the power output will reduce when the battery less than 20pcs.



192321202006003