

Frame lounge chair

by Ramón Esteve

Frame, outdoor collection by Ramon Esteve, comes from generating serene and timeless shapes using the framework as elementary geometry. The endless possibilities offered by the material using advanced technology, was the motivation to explore the limits.

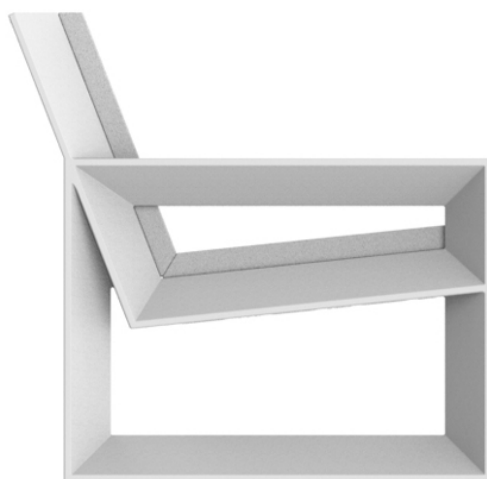

Info

Description

Made of polyethylene resin by rotational moulding. 100% Recyclable. Item suitable for indoor and outdoor use. Available in different finishes.

Weight: 20.6 Kg

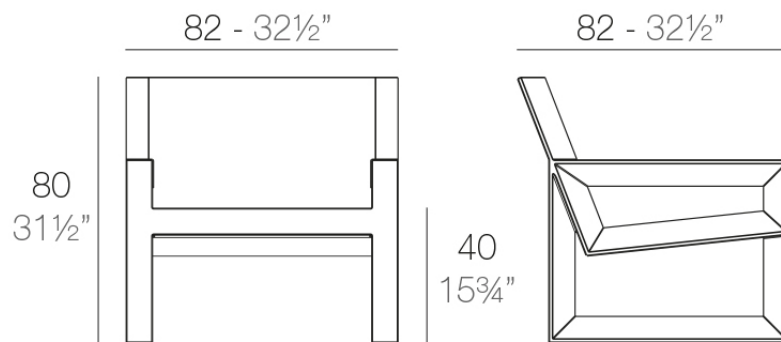

FRAME Butaca
FRAME Lounge Chair

Finishes

finishes

BASIC

Ref. 54088



orange



notte blue



crema

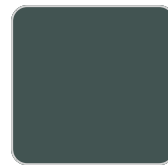

green

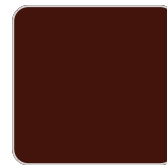

purjai red



white



black



steel



red



khaki



taupe



ecru



beige

Matt Polyethylene

LACQUERED

Ref. 54088F



orange



notte blue



crema



purjai red

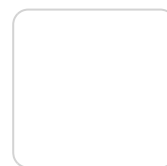

white

VONDOM



black



steel



red



khaki



taupe



ecru



beige



modo green



bronze



anthracite



champany

Lacquered Polyethylene

fabric

GLAD

Ref. 54088CO

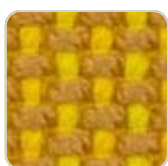

oro 1031



ocre 1051



sunset 1020



delhi 1038

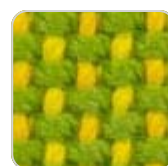

lima 1030



aguacate 1028

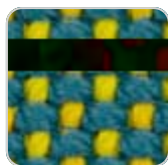

caribe 1004



bosc 1029



artemisa 1027

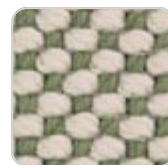

oasis 1007



oceano 1005



pruna 1045



noa 1026



berry 1021



amatista 1011

VONDOM

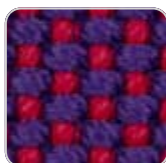

vera 1019



afrodita 1013



grana 1046



bacco 1034



dahlia 1035



wine 1012



foc 1052



hestia 1014



turquoise 1053



niord 1015



masai 1018

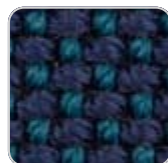

ultramar 1002



aquamarina 1003



esmeralda 1016

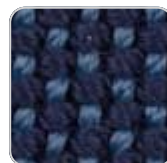

night 1024

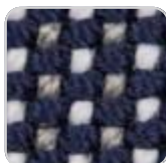

galan 1025



eclipse 1023

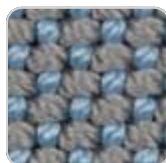

perla 1006



calipso 1017



snow 1041

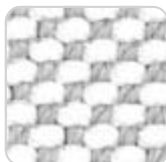

iceberg 1037



steel 1042



moon 1040



granito 1008



grey 1043



anthracite 1044

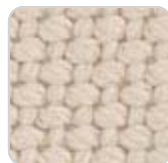

ecru 1047



dessert 1033



taupe 1048



terra 1039



duna 1009



moka 1010



chocolate 1050

Soft and cozy fabric suitable for indoor and outdoor use.

NAUTIC

VONDOM

Ref. 54088CO

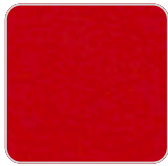

red 1108

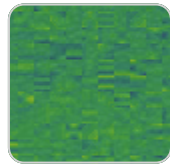

forest 1112



steel 1101



natural 1111



purjai red 1106



crema 1103



black 1105



notte blue 1114



taupe 1102



bronze 1104

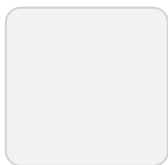

white 1100



orange 1113

Soft leather like fabric suitable for indoor and outdoor use. Standard option for upholstery.

SILVERTEX Ref. 54088CO



white 1219



forest 1224



purjai red 1223



notte blue 1222

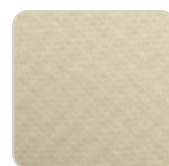

ecru 1221



natural 1220



bronze 1214



khaki 1218



steel 1208



taupe 1209



antrachite 1210

VONDOM

Vinyl fabric suitable for indoor and outdoor use. Special option for upholstery.

CREVIN

Ref. 54088CO

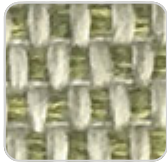

lemongrass 1303

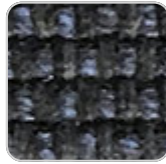

deep blue 1302

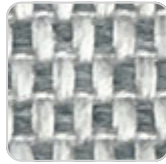

blue 1301



melon 1304



white 1308



steel 1309



taupe 1310



anthracite 1311

Upholstery fabric, that as and natural appearance and can be easy cleaned by washing machines, allowing an easy removal of mildew. Suitable for indoor and outdoor use

CICO

Ref. 54088CO



cranberry 1707



blueberry 1706



onyx 1705



greywacke 1704

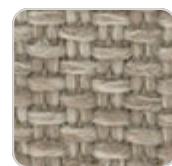

sandstone 1703



gravel 1702



limestone 1701

Cozy fabric with an elegant look and soft touch.

VONDOM

ACAPULCO Ref. 54088CO



acapulco 1806



acapulco 1805

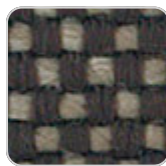

acapulco 1804



acapulco 1803



acapulco 1802



acapulco 1801

Cozy fabric with an elegant look and soft touch.

SIESTA Ref. 54088CO

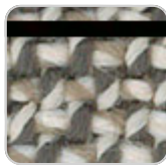

siesta 1811



siesta 1810



siesta 1813



siesta 1812

Cozy fabric with an elegant look and soft touch.

IKON Ref. 54088CO



ikon 1835



ikon 1834



ikon 1833



ikon 1832



ikon 1831

VONDOM



ikon 1830

Cozy fabric with an elegant look and soft touch.

HERITAGE

Ref. 54088CO



papyrus 1530



granite 1531

Outdoor fabrics are waterproof 50% recycled acrylic, 47% acrylic and 3% PE.

SAVANE

Ref. 54088CO



tornado 1503



whisper 1502

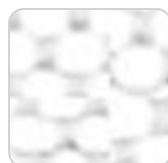

white 1501

Outdoor fabrics are waterproof 100% acrylic.

Ambients

