

Techn. Data / Daten:

Pihasauna Piha-Tuuri 13

Log length (W x D) / Bohlenaußenmaß (B x T): 257 x 555 cm

Wall size(outside) / Wandaußenmaß: 237 x 535 cm

Log thickness / Bohlenstärke: 70 mm

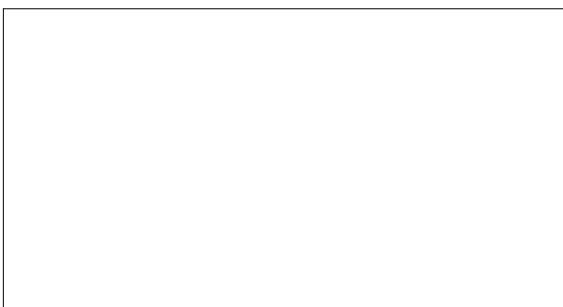
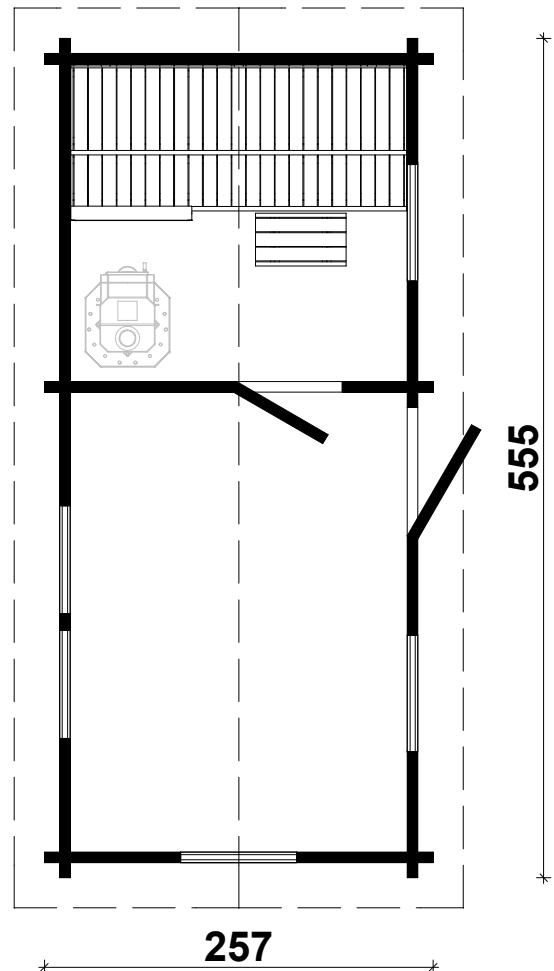

Note: All dimensions are approximate !

Pihasauna Piha-Tuuri 13 - 70 mm / 257 x 555 cm

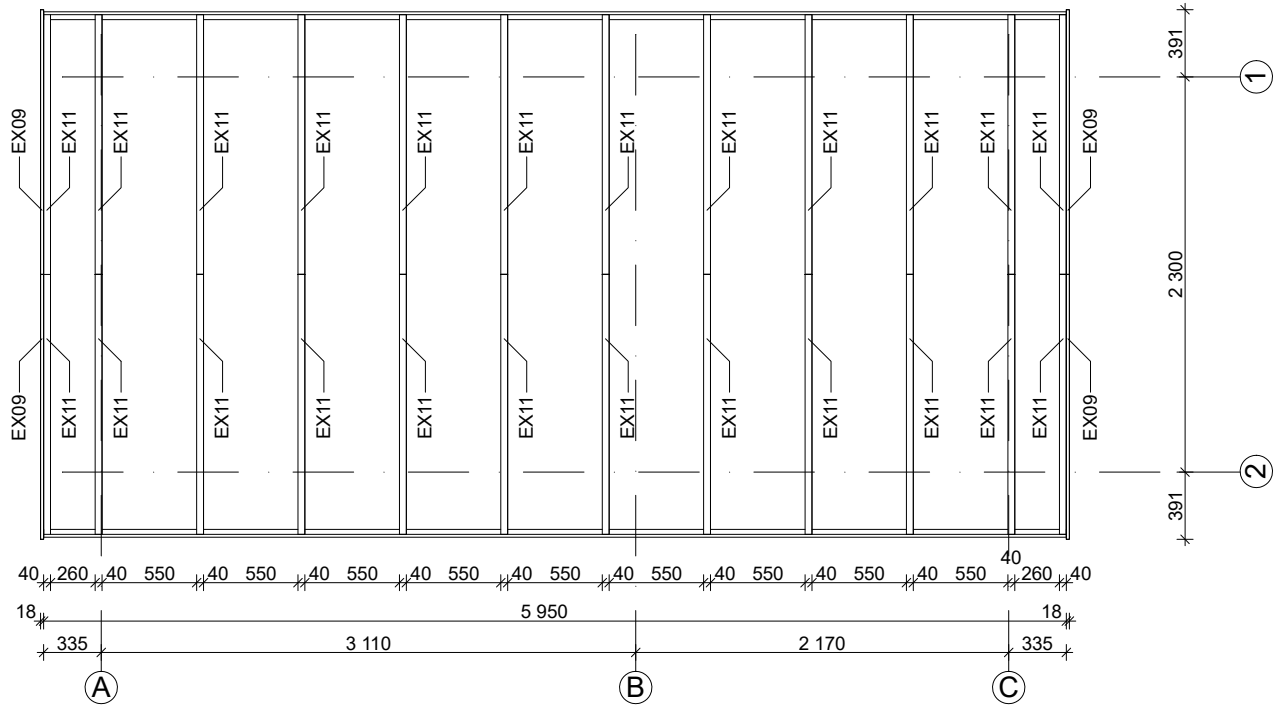



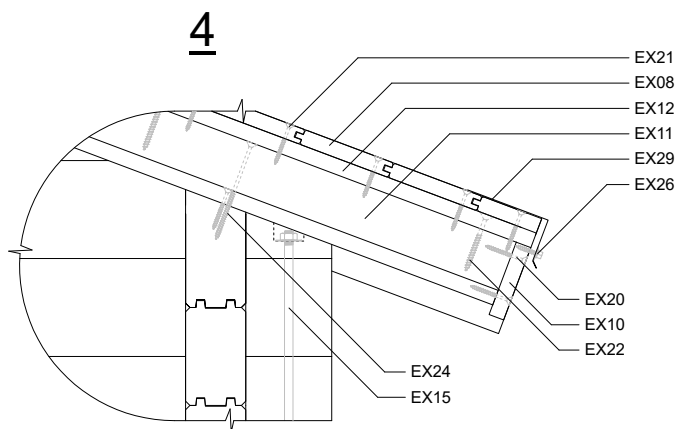
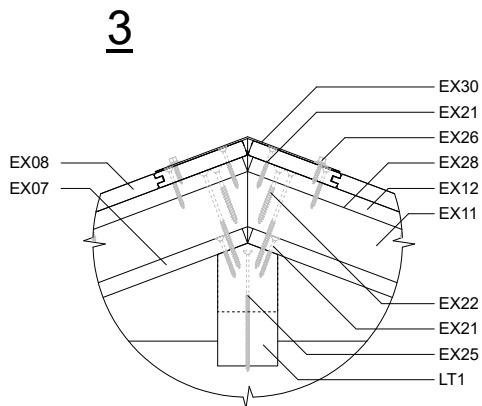
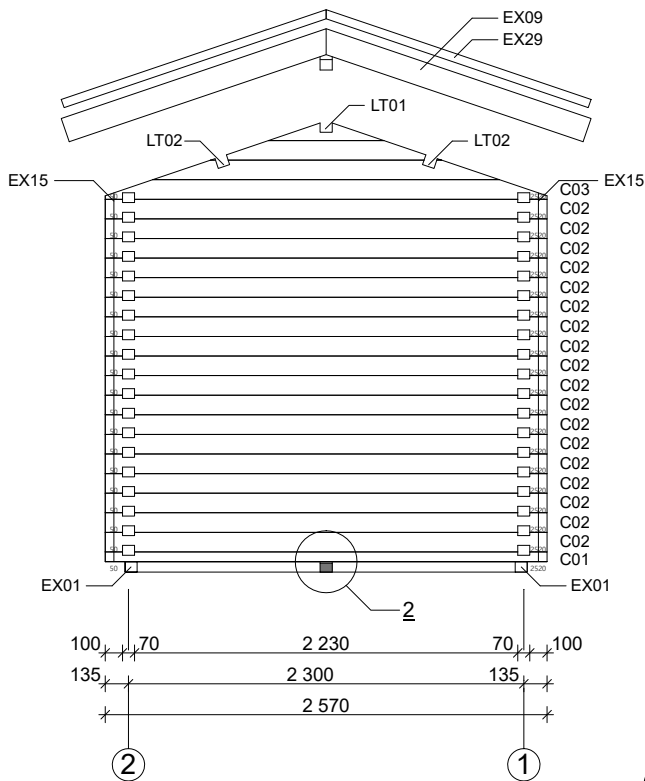



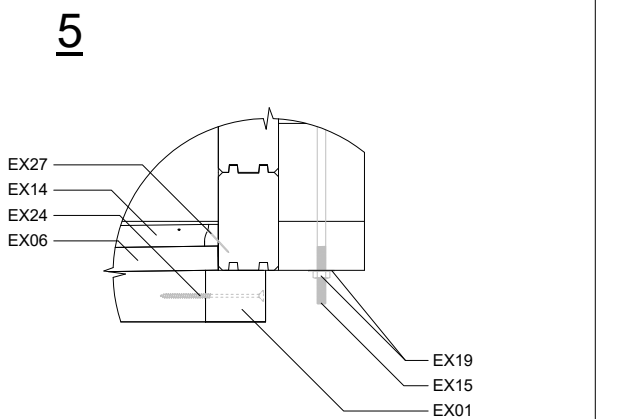
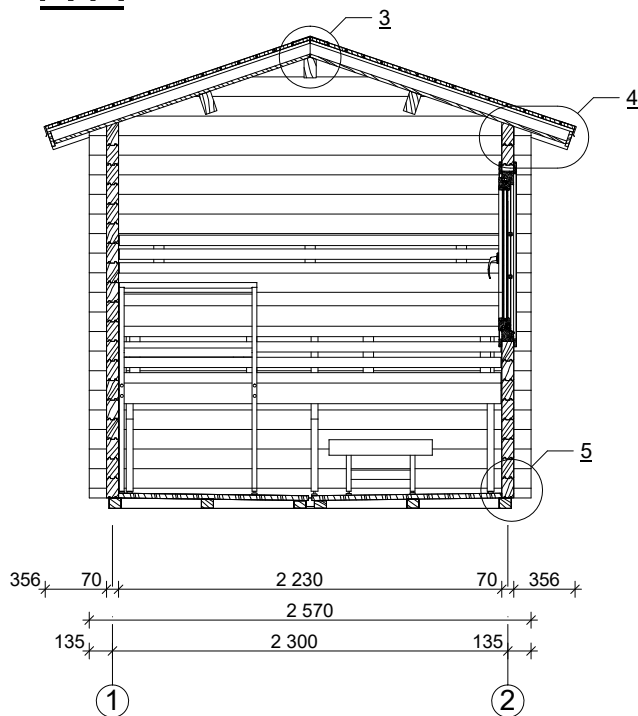

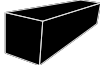

Pihasauna Piha-Tuuri 13 - 70 mm / 257 x 555 cm - C; A-A

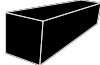
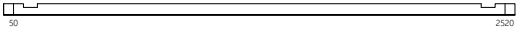
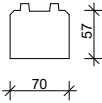

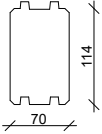

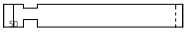
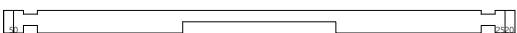
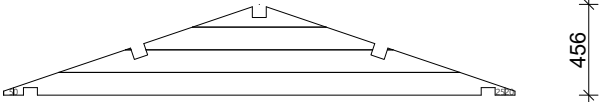

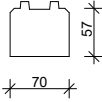
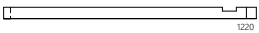
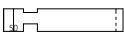
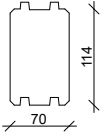

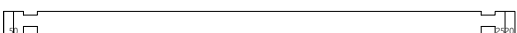
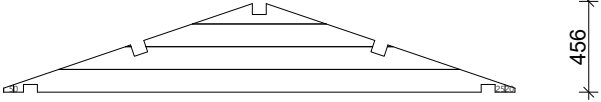



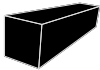

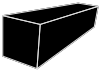
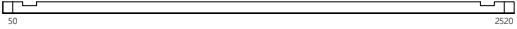
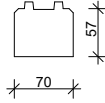
A-A

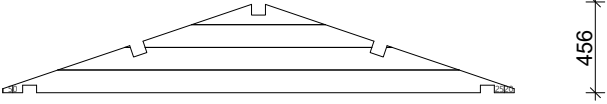
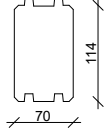

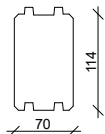
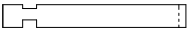
Pihasauna Piha-Tuuri 13 - 70 mm / 257 x 555 cm - A; B

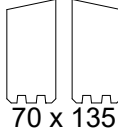
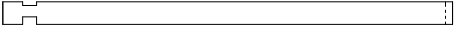
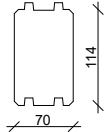













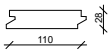
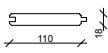
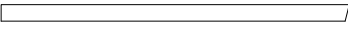
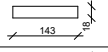
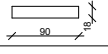
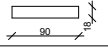

Nr.		 mm	 mm	 x
A01			2570	1
A02			2570	8
A03			2570	1
A04			900	16
A05			2570	1
A06				2570
B01			600	1
B02			1270	1
B03			600	17
B04			1270	17
B05			2570	1
B06			2570	1

Pihasauna Piha-Tuuri 13 - 70 mm / 257 x 555 cm - C; 1; 2

Nr.		 mm	 mm	 x
C01			2570	1
C02			2570	18
C03			2570	1
101			5550	9
102			920	9
103			3090	9
104			5950	1(1+0)
201			2260	8
202			2440	8
203			835	18
204			655	9

Pihasauna Piha-Tuuri 13 - 70 mm / 257 x 555 cm

Specification / Teileliste

Nr.		 mm	 mm	 x	
EX01	Foundation beams / Fundamenthölzer		5320	2	
EX02			2200	8	
EX03				2100	2
EX04					2100
EX05	Floor boards / Fußbodenbretter		3037		21+1
EX06			1105	40	
EX07	Ceiling boards / Deckenbretter		1570	110	
EX08	Roof board / Dachbretter		5950	30+2	
EX09	Fascia board / Giebelblende 		1628	4	
EX10	Eave edging / Traufenbrett 		5950	2	
EX11	Rafter / Dachsparren	40x60	1597	24	
EX12	Trim / Leiste	18x44	1615	24	
EX13	Diamond / Diamant			--	
EX14	Baseboard / Fußleisten		ca. 19,2 m		
EX15	Threaded Rod / Gewindestange	∅ 10	2200	6	
EX16	Hit block / Schlaghölzer	70x114			
EX17	Sauna set		2220	1	
EX18	Gutter / Rinne 		2275	1	
EX19	Nut, washer / Mutter, Scheibe			12	
EX20	Screws / Schrauben 4,0 x 40			130	
EX21	Screws / Schrauben 4,0 x 50			960	
EX22	Screws / Schrauben 5,0 x 70			110	
EX23	Screws / Schrauben 5,0 x 100			30	
EX24	Screws / Schrauben 5,0 x 120			90	
EX25	Screws / Schrauben 6,0 x 140			30	
EX26	Roof screw / Dachschraube			80	
EX27	Nails / Nägel 1,4 x 35			50	
EX28	Underlay / Unterlage		ca. 18,5 m		
EX29	Flashing		2500	8	
EX30	Flashing		1700	4	
EX31	Ventilation grate ∅100 mm			2	
EX32	Disc valve ∅100 mm			2	
EX33	Roofing felt / Dachpappe		roof area ca. 19,5 m ²		
EX34	Insulation / Dämmung 50 mm		ca. 17,7 m ²		

Sauna set

A-A

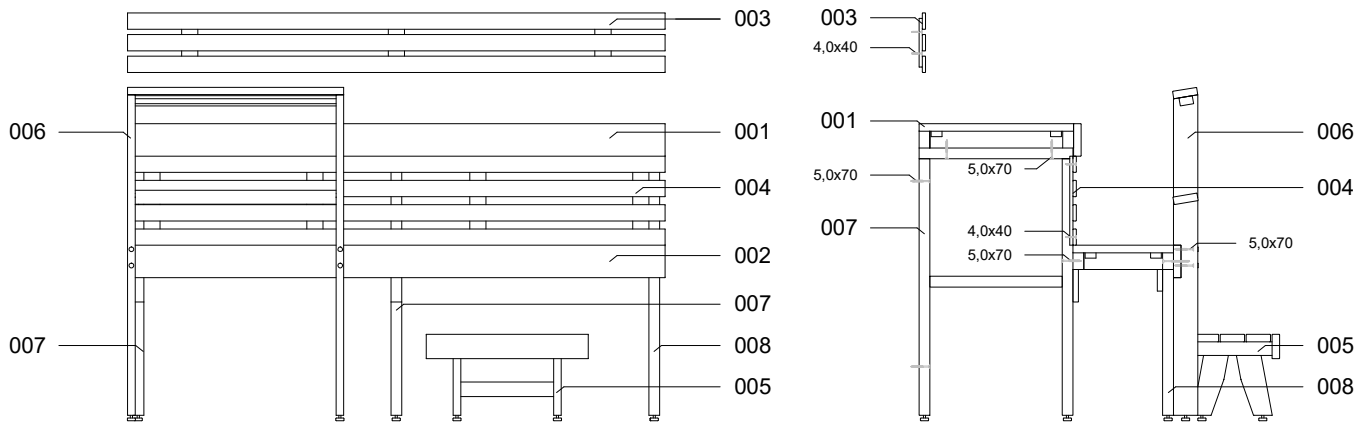



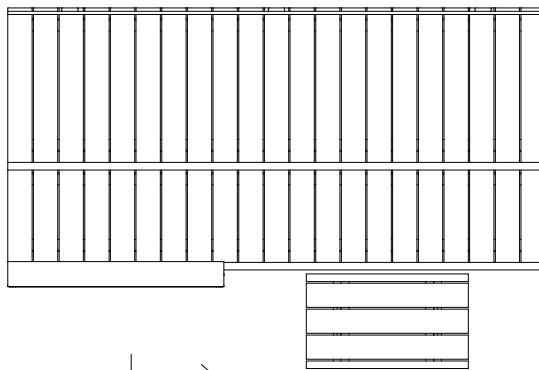

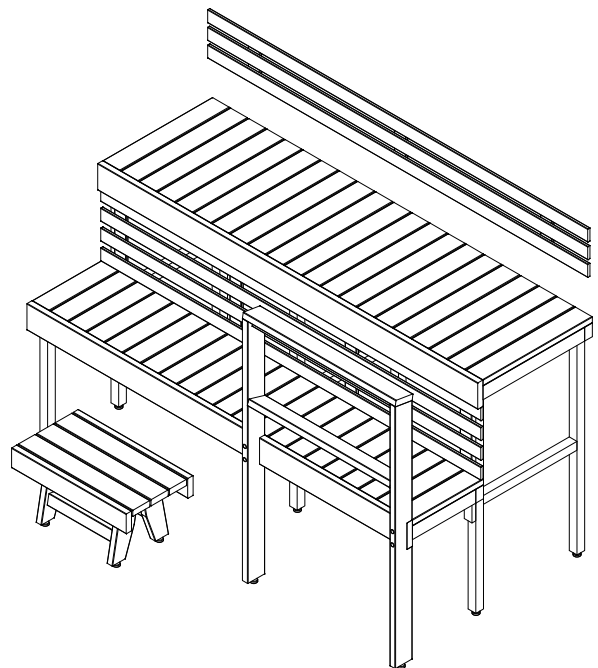
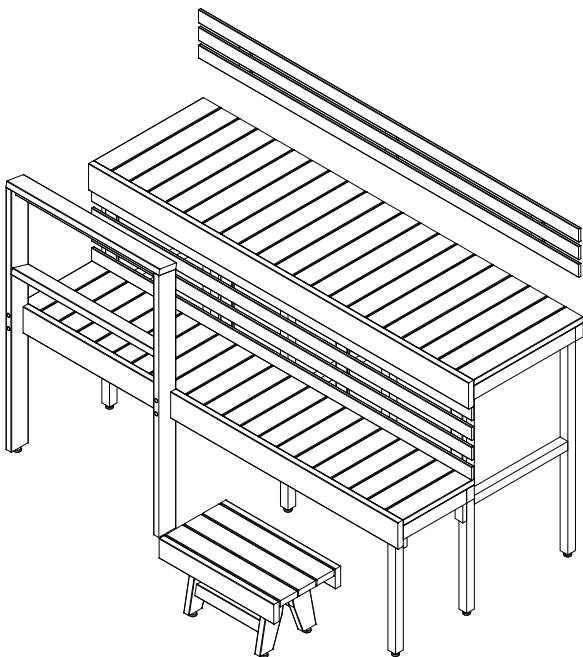

A →

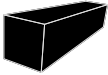
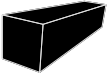

A →

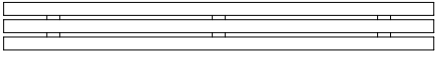
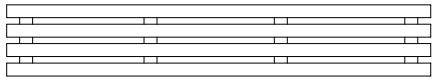

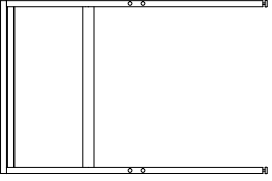
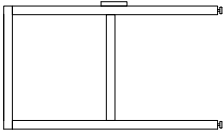
Sauna set Specification / Teileliste

Nr.		 x
001		1
002		1
003		1
004		1
005		1
006		1
007		3
008		1