

OALL 3 WOODEN POOL



WOODEN POOL EXPERTS

Read carefully pool installation manual and user guide before the installation!

QR CODE to User Guide



EN

PL

FR

DE



BEFORE INSTALLATION

This manual presents the correct assembly procedure for the swimming pool, step by step. We have undertaken all possible efforts to make sure that the materials are as close to the actual items and present their layout as closely as possible. Please remember, however, that all figures are indicative only and individual elements delivered in your set may be different than their graphical visualizations presented in the manual.

Follow the rules of safe use of the pool!

Before the installation, store the kit in a dry place which provides adequate air flow. Protect from the weather (sunlight, precipitation). Do not store under cover in direct sunlight. Store up carefully the unpacked wooden elements without exposure to direct sunlight and water.

Installation should be finished within 3 days from opening the package.



To protect wood from weather, it is advisable to apply preparations intended for the protection of external wooden constructions (e.g. oil scumble which is available in the current offer - product developed for the effective protection of wooden swimming pools). Pool preservation should be performed at least once a year, and for pools subject to extreme weather conditions even more often.

Lack of once a year conservation of the structure causes loss of warranty!



Before installation check quantity of elements and if they are not faulty. Missing elements or any damages should be reported before the installation. It is possible that some elements of equipment in the assembly instruction will not correspond exactly to those supplied.



Prepare essential tools indicated in the manual – tools are not included in the pool kit.



RUBBER PLUG

In order to prepare pool for the winter season (especially if there is a risk of freezing water) use a plug dedicated to shut the access of water to filtration system. Inlet must remain in the pool. Fix a plug under water. Remember to disconnect filtration set from source of water and dry the inlet (the part of inlet which is outside the pool). For winter season, it is recommended to get rid of water remaining in pump and sand filter, otherwise freezing water can cause devastation of whole set.



GROUND PREPARATION

Partly or fully in-ground pool must be secured in accordance with documentation enclosed in pool manual. Please see the drawing in the manual.

Wooden structure protection required:

- 1 – FOUNDATION**
- 2 – DRAINAGE PIPE**
- 3 – FOUNDATION BUBBLE WRAP**
- 4 – GRAVEL**
- 5 – GEOTEXTILE**
- 6 – GROUND**

In order to define the area for the pool, place the first layer, then remove it to prepare the area.

When preparing the area for the pool, remove grass, roots and stones.

The ground on which the pool is situated should be stable, solid, flat and, above all, levelled on the entire surface.

For the pool models without steel supports apply sand stabilized with cement or concrete screed.

For the pool models with steel supports, concrete base must be prepared in accordance with the diagram presented in the manual.

Manual guidelines for the arrangement of 2T posts and preparation of reinforced concrete screed must be strictly followed. All dimensions must comply with the manual guidelines.

We recommend that concrete floor is laid by specialized companies!



WOODEN STRUCTURE ASSEMBLY

The assembly of the structure starts with the first layer.

After arranging each layer, check the diagonals according to the drawing in the instruction.

To ensure that connections of tongues and grooves in construction planks are precise and tongues are not damaged, it is necessary to use a wooden knocking block. Hitting directly against the elements of the tongue or groove is unacceptable. Damages arising from this preclude the proper folding of the elements or reduce their durability.

Continue to assemble of all wooden elements in the order shown in the instructions.

OPTION → If your pool has a lighting option, install the lamp in the pool structure in accordance with the additional instructions attached to the lamp.



SKIMMER ASSEMBLY

Assemble all elements of a complete skimmer, and secure the threads with Teflon tape.

Note!

The moment of placing the skimmer in the wooden structure depends on the skimmer model. Perform this step according to the instructions in your pool's manual.

Skimmer should be screwed in the wooden structure in the indicated in manual time of installation and in indicated places. Cover the diffuser surfaces with double-sided tape and stick the gasket.



PREPARATION OF THE INNER SIDE OF THE POOL

Distribution of geotextile starts from the inner side of pool walls, for installation use double-sided tape or glue. Prepare holes for the skimmer and nozzles.

PVC profiles for liner installation cut to the indicated dimensions. Pay attention to the required angles. According to the diagram prepare the holes \varnothing 2 mm. Mount the profiles to the structure by connecting them along the entire pool. Plan profiles distribution to make as few joints as possible.

Spread the geotextile evenly over the pool floor, then start installing the liner (pool foil) in PVC profiles.

It is recommended to store the liner in its original packaging in a dry room at a moderate ambient temperature (15-25 degrees Celsius). Warm temperature makes liner material more manageable.

When installing the liner into the pool structure, make sure that joints and welds are perfectly distributed in the corners of the walls. Smooth all the folds. Pay attention to the places on the holes for lamp, nozzle, skimmer.

Install the liner in PVC profiles using liner lock.

When pouring water, straighten the liner on the ground with bare feet, level out any unevenness that may occur, at the same time stretch the liner walls down to the ground (pay great attention to the corners).

Pool water should be poured gradually, as indicated in manual.



FILTRATION SYSTEM

Stop the water level 5-10 cm before reaching the nozzle location and cut the hole for the nozzle according to the drawing in manual.

For the nozzle installation coat the liner facing side of the gasket with Vaseline, secure the thread of hose connector with Teflon tape and connect the hose to the nozzle, tighten with the hose clip. Adjust the hose clip gently, not to break the clamp. Watch for any leakage. If there is a leakage, apply more tape and tighten the clamp.

Fill half of the filter tank with water. Second half fill with the sand you can find in the pool kit.

Assembly the filtration set: valve, flange clamp, pressure gauge. Cover thread of hose connectors with Teflon tape. Connect elements of filtration system according to the guidelines shown in manual of your pool model. After completing this step, keep pouring water.



SKIMMER INSTALLATION

Stop pouring water when the water level is 5-10 cm below the skimmer, to cut a hole in the place of skimmer.

Please make sure to prepare a hole in the geotextile material before.

Fit the skimmer frame and thread it gently into the skimmer through the liner, for easier location of the skimmer placement. Do not cut the liner before the frame is screwed, the cut may shift and the hole may not fit the frame when it's screwed on.

Cut the hole, then remove the frame and install all skimmer elements in their place according to the drawing from the manual.

Make sure you connect all filter elements with hoses according to the instructions and continue filling with water. To ensure proper work of the filter set, top up the water level in the pool, to the half of the skimmer!



INSTALLATION OF THE TERRACE BOARDS

Place the pool decking boards according to the diagram presented in the manual.

To assemble the movable board (for easy access to the skimmer), use the hinges included in the set.



Wooden corner connectors attach to the bottom of the terrace boards.

It is advisable to install the terrace planks after the pool is filled with water. For aesthetic reasons, it is recommended to remove and re-lay the terrace planks within 1–2 weeks from filling up the pool.

Pay attention to the even distribution of the terrace screws.

After completing the installation of the terrace boards, proceed with the installation of the external stairs and internal ladder.

OPTION → If your pool has corner covers as an option perform the installation as in manual.

Lesen Sie vor der Installation die Anweisungen und das Benutzerhandbuch!

QR CODE für den BENUTZERHANDBUCH



EN

PL

FR

DE



VOR DEM EINBAU

Die Anleitung, die Sie in den Händen halten, zeigt Ihnen Schritt für Schritt, wie Sie Ihren Pool richtig installieren. Wir haben uns bemüht, Materialien zusammenzustellen, die den tatsächlichen Zustand und das Aussehen der verschiedenen Elemente so genau wie möglich wiedergeben. Bitte beachten Sie jedoch, dass alle Darstellungen nur der Veranschaulichung dienen und es möglich ist, dass die einzelnen Elemente, die in Ihrem Set geliefert werden, tatsächlich von der grafischen Darstellung in der Anleitung abweichen können.

Befolgen Sie die Regeln für die sichere Benutzung von Pools!

Lagern Sie das Paket vor der Installation an einem trockenen Ort mit ausreichender Luftzirkulation und schützen Sie es vor schädlichen Witterungseinflüssen (Sonnenlicht, Niederschlag). Nicht abgedeckt in direktem Sonnenlicht aufbewahren. Lagern Sie die unverpackten Holzteile sorgfältig, ohne sie direktem Sonnenlicht oder Wasser auszusetzen.

Installation innerhalb von 3 Tagen nach dem Auspacken der Bestandteile.



Um das Holz vor Witterungseinflüssen zu schützen, empfehlen wir, die Holzoberfläche des Pools mit Präparaten zu behandeln, die für den Schutz von Holzkonstruktionen im Außenbereich bestimmt sind (z. B. Öllack, der in unserem aktuellen Angebot erhältlich ist - ein Produkt, das speziell für den wirksamen Schutz von Holzbecken entwickelt wurde). Die Wartung des Pools sollte mindestens einmal im Jahr erfolgen, bei Pools, die extremen Witterungsbedingungen ausgesetzt sind, sogar noch häufiger.

Wird der Pool nicht jährlich gewartet, erlischt die Garantie!



Überprüfen Sie vor dem Einbau sorgfältig die Zahl und die Unversehrtheit der Bauteile. Die Zubehörteile in der Anleitung können leicht von den tatsächlich gelieferten abweichen. Etwaige Mängel oder Schäden müssen vor der Montage gemeldet werden.



Bereiten Sie das in der Anleitung angegebene Werkzeug vor - Werkzeuge sind nicht im Lieferumfang enthalten.



DÜSENSTOPFEN

Um den Pool für die Wintersaison vorzubereiten (vor allem, wenn die Gefahr besteht, dass das Wasser einfriert), verwenden Sie einen Stopfen für die Einlaufdüsen, um die Wasserzufuhr zur Filteranlage zu unterbrechen. Lassen Sie die Düse im Becken, setzen Sie den Stopfen unter Wasser ein. Denken Sie auch daran, den Filtersatz von der Wasserquelle zu trennen und die Düse gründlich von außen zu trocknen. Es ist ferner ratsam, während der Winterzeit das Restwasser aus der Pumpe und dem angeschlossenen Sandfilter zu entfernen, da sonst gefrierendes Wasser das gesamte Set zerstören kann (Froststellen).



VORBEREITUNG DES UNTERGRUNDES

Die Struktur eines ganz oder teilweise in den Boden eingegrabenen Schwimmbeckens muss gemäß den Richtlinien in der Anleitung geschützt werden.

Ein Schutz gemäß der Zeichnung im Handbuch ist erforderlich:

- 1 - FUNDAMENT DES POOLS**
- 2 - DRAINAGEROHR**
- 3 - FUNDAMENT DER NOPPENFOLIE**
- 4 - SCHOTTER**
- 5 - GEOTEXTIL**
- 6 - BODEN**

Um den Bereich für das Schwimmbecken abzustecken, wird eine erste Schicht verlegt, die dann zur Vorbereitung des Bodens entfernt wird.

Wenn Sie den Bereich für Ihren Pool abstecken, entfernen Sie Gras, Wurzeln und Steine.

Der Boden für den Pool muss fest, flach und eben sein!

Bei Becken ohne Stahlstützen - zementstabilisierten Sand (Schicht - 2 cm) oder Betonestrich verwenden.

Im Falle eines Pools mit Stahlstützen muss der Boden der Baugrube / des Betonestrichs gemäß dem in der Anleitung gezeigten Schemavorbereitet werden .

Die Richtlinien für die Platzierung der 2T Pfosten und die Vorbereitung der Bewehrung für den Estrich müssen strikt eingehalten werden, alle Abmessungen müssen den Richtlinien im Handbuch entsprechen.

Wir empfehlen, den Estrich von Fachfirmen ausführen zu lassen.



EINBAU DER HOLZKONSTRUKTION

Beginnen Sie mit dem Einbau der Struktur mit der ersten Schicht.

Überprüfen Sie die Diagonalen nach dem Verlegen jeder Lage, die Maße müssen den Angaben in der Anleitung entsprechen.

Verwenden Sie beim Verlegen der aufeinanderfolgenden Schichten den mit den Holzelementen der Struktur gelieferten Schlagklotz. Ein direktes Schlagen auf die Nut- und Federteile ist nicht zulässig. Die daraus resultierenden Schäden machen den Zusammenbau der Bauteile unmöglich oder schwächen ihre Festigkeit.

Fahren Sie mit dem Zusammenbau der einzelnen Hölzer in der in der Anleitung angegebenen Reihenfolge fort.

OPTION → Wenn Ihr Schwimmbecken über eine Beleuchtungsoption verfügt, installieren Sie die Lampe der Poolstruktur gemäß den zusätzlichen Anweisungen, die der Leuchte beiliegen.



VORBEREITUNG DES ABSCHÄUMERS

Bauen Sie die Einzelteile zu einem kompletten Abschäumer zusammen und sichern Sie die Gewinde mit Teflonband.

Achtung!

Der Zeitpunkt des Einbaus des Abschäumers in die Holzkonstruktion hängt vom Modell des Abschäumers ab. Führen Sie diesen Schritt gemäß der Anleitung für Ihren Pool durch.

Der Abschäumer sollte in der entsprechenden Phase und an den angegebenen Stellen angeschraubt werden.

Bei der Montage sollten die Auslassflächen mit doppelseitigem Klebeband abgedeckt und die Dichtung aufgeklebt werden.



VORBEREITUNG DER INNENSEITE DES POOLS

Verlegen Sie das Geotextil mit doppelseitigem Klebeband oder Klebstoff. Beginnen Sie mit den Innenwänden des Pools. Bereiten Sie die Löcher für den Skimmer und die Düsen in dem gleichmäßig verteilten Geotextil vor.

Schneiden Sie die Profile für die Befestigung der Folie für den Pool auf die angegebenen Maße zu und achten Sie dabei auf die Einhaltung der erforderlichen Winkel. Bohren Sie wie gezeigt \varnothing 2 mm große Löcher in die Profile. Anschließend werden die Profile an die Struktur angepasst, indem sie um den Rand des Pools herum verbunden werden. Denken Sie daran, dass die Profile in Längsrichtung zusammengefügt werden, also planen Sie Ihr Layout so, dass möglichst wenig Fugen entstehen.

Verteilen Sie das Geotextil gleichmäßig auf dem Boden des Schwimmbeckens und beginnen Sie dann mit der Verlegung der Auskleidung (Folie für den Pool) in den PVC-Profilen.

Lagern Sie die verpackte Folie für den Pool vor der Verlegung an einem trockenen Ort bei einer Raumtemperatur von 15-25 Grad Celsius. Durch die warme Temperatur lässt sich das Material leichter in die Struktur einpassen und anbringen.

Passen Sie die Ecken der Folie für den Pool sorgfältig an die Ecken des Pools an. Glätten Sie eventuelle Falten. Achten Sie auf die Bereiche um die Löcher für die Lampe, die Düse und den Skimmer.

Setzen Sie die Folie für den Pool in die PVC-Profile ein, indem Sie sie mit einem Stopfen andrücken.

Während des Eingießens des Wassers die Folie mit bloßen Füßen auf dem Boden ausbreiten, Unebenheiten ausgleichen und die Wände bis zum Boden ausziehen (dabei besonders auf die Ecken achten).

Das Schwimmbadwasser sollte nach und nach, wie in der Anleitung angegeben, nachgefüllt werden.



FILTERSYSTEM

Stoppen Sie die Wasserbefüllung 5-10 cm vor der für die Düse vorgesehenen Stelle und schneiden Sie das Loch für die Düse wie in der Anleitung angegeben aus.

Schmieren Sie die Dichtungen auf der Auskleidungsseite mit Vaseline ein, bringen Sie die Stutzen an, bedecken Sie die Stutzensgewinde mit Teflonband, bringen Sie dann den Schlauch am Stutzen an und befestigen Sie ihn mit Schneckenbändern. Stellen Sie den Druck vorsichtig ein, um das Band nicht zu zerreißen, und beobachten Sie, ob es undicht ist. Wenn keine Dichtung vorhanden ist, bringen Sie mehr Klebeband an und ziehen Sie das Band fest.

Füllen Sie den Filterbehälter bis zur Hälfte mit Wasser. Füllen Sie die andere Hälfte des Filterbehälters mit dem im Bausatz enthaltenen Sand.

Montieren Sie den Filtersatz, bestehend aus Ventil, Schelle und Manometer. Bedecken Sie die Schlauchanschlüsse mit Teflonband, sowohl am Gewinde als auch am Schlauchanschluss.

Schließen Sie die Komponenten des Filtersystems gemäß den Anweisungen Ihres Modells an.

Danach weiter mit Wasser auffüllen



MONTAGE DES ABSCHÄUMERS

Hören Sie auf einzugießen, wenn der Wasserstand 5-10 cm unter der für den Abschäumer vorgesehenen Stelle liegt, um ein Loch für den Abschäumer in die Folie zu schneiden. Denken Sie daran, vorher Löcher in das Vlies unter der Folie für den Pool zu schneiden.

Bringen Sie den Rahmen für den Abschäumer innen an und schrauben Sie ihn vorsichtig durch die Auskleidung hindurch an der Außenseite des Abschäumers fest, um die Position des Ausschnitts leichter markieren zu können. Schneiden Sie die Auskleidung nicht vor dem Anschrauben des Rahmens zu, der Schnitt könnte sich verschieben und das entstandene Loch könnte beim Anschrauben des Rahmens nicht passen.

Schneiden Sie das Loch aus, entfernen Sie dann den Rahmen und setzen Sie die anderen Elemente des Abschäumers an seiner Stelle ein. Dichtung, Rahmen und Abdeckung. Folgen Sie der Abbildung in der Anleitung.

Vergewissern Sie sich, dass Sie alle Filterelemente mit den Schläuchen gemäß den Anweisungen angeschlossen haben, und fahren Sie mit dem Befüllen mit Wasser fort.

Um einen ordnungsgemäßen Betrieb des Filtersets zu gewährleisten, füllen Sie den Wasserstand im Becken bis zur Mitte des Abschäumers auf!



VERLEGUNG VON TERRASSENDIELEN

Verlegen Sie die Terrassendielen für den Pool gemäß dem Plan in der Anleitung.

Verwenden Sie die mitgelieferten Scharniere, um die bewegliche Platte für den Zugang zum Abschäumer zu montieren.



Montieren Sie die Eckverbinder an der Unterseite der Terrassendielen.

Um die Ästhetik zu verbessern, wird empfohlen, die Terrassendielen innerhalb von 1-2 Wochen nach dem Befüllen des Pools zu entfernen und neu zu verlegen.

Achten Sie darauf, dass die Terrassenschrauben in gleichmäßigen Abständen angebracht werden.

Sobald die Terrassendielen fertiggestellt sind, können Sie mit der Montage der Außentreppe und der Innenleiter fortfahren.

OPTION → Wenn Ihr Pool über die Möglichkeit von Eckblenden verfügt, führen Sie deren Einbau gemäß den Anweisungen aus.

Lisez les instructions et le guide de l'utilisateur avant de procéder à l'installation !

CODE QR pour Le Guide



EN

PL

FR

DE



AVANT L'INSTALLATION

Les instructions que vous avez en main vous montrent, étape par étape, comment installer correctement votre piscine. Nous nous sommes efforcés de préparer des documents qui reflètent le plus fidèlement possible l'état réel et l'aspect des différents éléments. Cependant, veuillez noter que tous les dessins ne sont donnés qu'à titre d'illustration et qu'il est possible que les éléments individuels fournis dans votre kit diffèrent en fait de leur visualisation graphique contenue dans les instructions.

Suivez les règles pour une utilisation de la piscine en toute sécurité !

Avant l'installation, stockez l'emballage dans un endroit sec avec une circulation d'air adéquate, protégez-le des conditions atmosphériques dommageables (soleil, précipitations). Ne pas stocker sous abri à la lumière directe du soleil. Conservez soigneusement les éléments en bois non emballés sans les exposer à la lumière directe du soleil ou à l'eau.

Installer dans les 3 jours suivant le déballage de la structure.



Afin de protéger le bois contre les conditions atmosphériques, nous recommandons de finir la surface en bois de la piscine avec des préparations conçues pour protéger les structures externes en bois (par exemple, le vernis à l'huile disponible dans notre offre actuelle - le produit spécialement conçu pour une protection efficace des piscines en bois). L'entretien de la piscine doit être effectué au moins une fois par an, et dans le cas des piscines soumises à des conditions atmosphériques extrêmes, même plus souvent.

L'absence d'entretien annuel de la structure annule la garantie !



Avant l'installation, vérifiez soigneusement la quantité et que les éléments ne sont pas endommagés. Les différents raccords indiqués dans les instructions peuvent différer légèrement de ceux qui sont effectivement fournis. Toute défectuosité ou tout dommage doit être signalé avant l'installation.



Préparez les outils nécessaires indiqués dans les instructions - les outils ne sont pas inclus dans le kit.



BOUCHON DE LA BUSE

Pour préparer la piscine pour l'hiver (surtout s'il y a un risque de gel de l'eau), utilisez un bouchon pour les buses d'entrée afin de couper l'alimentation en eau du groupe de filtration. Laissez la buse dans la piscine, installez le bouchon sous l'eau. N'oubliez pas non plus de débrancher le jeu de filtres de la source d'eau et de sécher soigneusement la buse de l'extérieur. Il est également conseillé d'éliminer toute l'eau résiduelle de la pompe et du filtre à sable qui y est attaché pendant la période hivernale (endroits où il y a le risque de gel), sinon l'eau gelée peut détruire l'ensemble.



PRÉPARATION DU SOL

La structure d'une piscine entièrement ou partiellement enterrée dans le sol doit être protégée conformément aux directives des instructions.

Une protection conforme au dessin des instructions est nécessaire :

- 1 - FONDATION DE LA PISCINE**
- 2 - TUYAU DE DRAINAGE**
- 3 - PROTECTION DE SOUBASSEMENT**
- 4 - GRAVIER**
- 5 - GÉOTEXTILE**
- 6 - SOL**

Pour délimiter la zone de la piscine, on pose une première couche, que l'on enlève ensuite pour préparer le terrain.

Lorsque vous délimitez l'emplacement de votre piscine, enlevez l'herbe, les racines et les pierres.

Le sol sous la piscine doit être ferme, plat et de niveau !

Dans le cas de piscines sans supports en acier - utiliser du sable stabilisé au ciment (couche - 2 cm) ou une chape en béton.

Dans le cas d'une piscine avec des supports en acier - la base de la fondation / la chape de béton doit être préparée conformément au schéma figurant dans les instructions.

Les directives pour le positionnement des poteaux 2T et la préparation de l'armature pour la chape doivent être strictement respectées, toutes les dimensions doivent suivre les directives trouvées dans le manuel.

Nous recommandons que la chape de béton soit réalisée par des entreprises spécialisées.



INSTALLATION DE LA STRUCTURE EN BOIS

Commencez à installer la structure avec la première couche.

Vérifiez les diagonales après la pose de chaque couche, les dimensions doivent être conformes aux instructions.

Lors de la pose des couches successives, utiliser la cale de frappe fournie avec les éléments en bois de la structure. L'impact direct sur les éléments de la languette ou de la rainure n'est pas autorisé. Les dommages qui en résultent rendent impossible l'assemblage des composants ou affaiblissent leur résistance.

Continuez à assembler les différentes pièces de bois dans l'ordre indiqué dans les instructions.

OPTION → Si votre piscine est équipée d'une option d'éclairage, installez la lampe dans la structure de la piscine selon les instructions supplémentaires fournies avec la lampe.



PRÉPARATION DE L'ÉCUMOIRE

Assemblez les différents éléments pour former une écumoire complète, en fixant les filets avec du ruban en téflon.

Attention !

Le temps d'installation de l'écumoire dans la structure en bois dépend du modèle de l'écumoire. Effectuez cette étape conformément aux consignes figurant dans les instructions de votre piscine.

L'écumoire doit être vissée à l'étape appropriée et aux endroits indiqués.

Lors de l'installation, les surfaces du diffuseur doivent être recouvertes de ruban adhésif double face et le joint doit être collé en place.



PRÉPARATION DE L'INTÉRIEUR DE LA PISCINE

Installez le géotextile à l'aide de ruban adhésif double face ou de colle. Commencez par les parois intérieures de la piscine. Préparez les trous pour l'écumoire et les buses dans le géotextile uniformément réparti.

Découpez les profilés de fixation de la membrane de piscine aux dimensions indiquées, en veillant à respecter les angles requis. Faites des trous de \varnothing 2 mm dans les profilés comme indiqué. Ajustez ensuite les profilés à la structure en les joignant autour du périmètre de la piscine. N'oubliez pas que les profilés sont assemblés dans le sens de la longueur, et que vous devez donc prévoir le moins de joints possible.

Étalez le géotextile uniformément sur la base de la piscine, puis commencez à installer la membrane (le liner) dans les profilés en PVC.

Stockez la membrane de piscine emballée dans un endroit sec à une température ambiante de 15-25 degrés Celsius avant de l'installer. La température chaude rendra le matériau plus facile à ajuster et à installer dans la structure

Ajustez soigneusement les coins du film de piscine aux coins de la piscine. Lissez les plis éventuels. Faites attention aux zones autour des trous pour la lampe, la buse, l'écumoire.

Installez la membrane de piscine dans les profilés en PVC en appuyant avec le joint (un bouchon).

Au moment de verser l'eau, étalez le revêtement sur le sol, pieds nus, en aplanissant les plis, tout en étirant les parois jusqu'au sol (en faisant particulièrement attention aux angles).

L'eau de la piscine doit être complétée progressivement comme indiqué dans les instructions.



SYSTÈME DE FILTRATION

Arrêtez le remplissage d'eau 5-10 cm avant l'endroit prévu pour la buse et découpez le trou pour la buse comme indiqué dans les instructions.

Lubrifiez les joints du côté du revêtement avec de la vaseline, fixez les buses, couvrez les filets de la buse avec du ruban en téflon, puis fixez le tuyau à la buse et attachez-le avec des serre-joints à vis sans fin. Ajustez la pression avec précaution pour ne pas casser le serre-joint, observez s'il y a des fuites. En cas de manque d'étanchéité, appliquez plus de ruban adhésif et resserrez le serre-joint.

Remplissez le réservoir du filtre à moitié avec de l'eau. Remplissez l'autre moitié du réservoir du filtre avec le sable inclus dans le kit.

Assemblez le kit de filtration composé de la valve, du collier et du manomètre. Recouvrez les raccords de tuyaux de ruban en téflon aux points de filetage et de raccordement des tuyaux.

Raccordez les éléments du système de filtration conformément aux instructions de votre modèle.

Continuez à remplir d'eau après cette étape



INSTALLATION DE L'ECUMOIRE

Arrêtez de verser l'eau lorsque le niveau d'eau atteint 5 à 10 cm en dessous de l'endroit désigné pour l'écumoire afin de découper un trou dans la membrane pour l'écumoire. N'oubliez pas de découper au préalable des trous dans le géotextile sous la membrane de la piscine.

Installez le cadre de l'écumoire à l'intérieur et vissez-le doucement à l'extérieur de l'écumoire à travers la membrane pour faciliter le marquage de l'emplacement de la découpe. Ne coupez pas la membrane avant de visser le cadre, la coupe pourrait se déplacer et le trou fait pourrait ne pas être adapté lorsque le cadre sera vissé.

Découpez le trou, puis retirez le cadre, en installant les autres éléments de l'écumoire à sa place. Joint, cadre et grille. Suivez l'illustration dans les instructions.

Assurez-vous que vous avez connecté tous les éléments de filtration avec les tuyaux selon les instructions et continuez à remplir d'eau.

Pour garantir le bon fonctionnement du groupe de filtration, remplissez le niveau d'eau de la piscine jusqu'au milieu de l'écumoire !



INSTALLATION DE PLANCHES DE TERRASSE

Posez les planches de la terrasse de la piscine conformément au schéma figurant dans les instructions.

Utilisez les charnières incluses pour monter le panneau mobile afin d'accéder à l'écumoire.



Installez les connecteurs d'angle sur la face inférieure des planches de terrasse.

Pour améliorer l'esthétique, il est recommandé d'enlever et de replacer les planches de terrasse dans les 1 à 2 semaines suivant le remplissage de la piscine.

Veillez à ce que les vis de terrasse soient régulièrement espacées.

Une fois le montage des planches de terrasse terminé, procédez à l'installation de l'escalier extérieur et de l'échelle intérieure.

OPTION → Si votre piscine dispose de l'option de grilles d'angle, effectuez leur installation comme indiqué dans els instructions.

¡Lea detenidamente el manual de instalación de la piscina y la guía del usuario antes de la instalación!

QR CODE e GUIDE



EN

PL

FR

DE



ANTES DE LA INSTALACIÓN

Este manual presenta paso a paso, el procedimiento correcto para el montaje de la piscina. Hemos realizado todos los esfuerzos posibles para asegurarnos de que los dibujos gráficos estén lo más cerca posible de las piezas reales y presenten su diseño lo más parecido posible. Sin embargo, recuerde que los dibujos son solo indicativos y que las piezas entregadas pueden ser diferentes de sus visualizaciones gráficas presentadas en el manual.

¡Siga las instrucciones de uso de la piscina!

Antes de la instalación, guarde el kit en un lugar seco que proporcione un ambiente adecuado. Debe proteger el kit de montaje de la luz del sol directa y de la lluvia. Guarde cuidadosamente los elementos de madera desempaquetados sin exponerlos al sol ni al agua.

La instalación debe finalizarse dentro de los 3 días posteriores a la apertura del paquete.



Para proteger la madera de las temperaturas, es aconsejable aplicar productos de protección para maderas de uso externo (por ejemplo, aceite protector - que encontrará disponible en el catálogo – producto desarrollado para la protección de piscinas de madera).

La conservación de la piscina debe realizarse al menos una vez al año, y para las piscinas sujetas a condiciones climáticas extremas debe realizarse con mayor frecuencia.

¡La falta de conservación una vez al año causa pérdida de garantía!



Antes de la instalación compruebe que dispone de todos los elementos y que no presenten ningún desperfecto. Los elementos faltantes o cualquier defecto deben ser reportados antes de la instalación. Es posible que algunos elementos no correspondan exactamente a los que aparecen en las instrucciones.



Prepare las herramientas necesarias indicadas en el manual: las herramientas no están incluidas en el kit de la piscina.



TAPÓN DE GOMA

Para preparar la piscina para la temporada de invierno (especialmente si existe el riesgo de congelación del agua) use un tapón para cerrar el acceso del agua al sistema de filtración. La entrada debe permanecer en la piscina. Fije un tapón bajo el agua. Recuerde desconectar el sistema de filtración de la fuente de agua y secar la entrada (la parte de la entrada que está fuera de la piscina). Para la temporada de invierno, se recomienda deshacerse del agua que queda en la bomba y el filtro de arena, de lo contrario, el agua congelada puede causar el daño de toda la instalación.



PREPARACIÓN DEL TERRENO

La piscina, ya sea parcial o totalmente enterrada, debe asegurarse de acuerdo con la documentación adjunta en el manual. Por favor, vea el dibujo en las instrucciones.

Estructura requerida:

- 1 – BASE
- 2 –DRANAJE
- 3 – LÁMINA DRENAJE
- 4 – GRAVA
- 5 – GEOTEXTIL
- 6 – SUELO

Para definir el área de la piscina, coloque la primera capa y luego retírela para preparar la zona.

Al preparar la zona de la piscina, retire la hierba, las raíces y las piedras.

El suelo en el que se encuentra la piscina debe ser estable, sólido, plano y sobre todo, anivelado en toda su superficie.

Para los modelos de piscinas sin soportes de acero, se debe aplicar arena estabilizada con cemento o hormigón. Para los modelos de piscinas con soportes de acero, la base de hormigón debe prepararse de acuerdo con el diagrama presentado en el manual.

Las pautas manuales para la estructura de los puestos 2T y la preparación del suelo de hormigón deben seguirse estrictamente. Las dimensiones deben cumplir con las directrices del manual.

¡Recomendamos que el suelo de hormigón sea aplicado por empresas especializadas!



MONTAJE DE ESTRUCTURA DE MADERA

El montaje de la estructura de madera empieza con la primera capa.

Después de colocar cada capa, verifique las diagonales de acuerdo con el dibujo de las instrucciones.

Para garantizar que las conexiones de las lengüetas y las ranuras de los tabloncillos sean precisas y que las lengüetas no se dañen, es necesario usar un bloque de madera. No se debe golpear directamente los elementos de la lengüeta ni ranuras ya que los daños derivados de esto impiden el plegado adecuado de los elementos o reducen su durabilidad.

Continúe colocando todas las piezas en el orden que se muestra en las instrucciones.

OPCIÓN → Si su piscina tiene la opción de iluminación, instale la lámpara en la estructura de la piscina de acuerdo con las instrucciones adicionales adjuntas.



MONTAJE DEL SKIMMER

Monte todos los elementos de un skimmer completo y asegure las roscas con cinta de teflón.

¡Nota!

El momento de colocar el skimmer en la estructura de madera depende del modelo de skimmer. Realice este paso de acuerdo con las instrucciones del manual de su piscina.

El skimmer debe atornillarse en la estructura de madera como indica el manual de instalación y en los lugares indicados. Cubra las superficies del difusor con cinta adhesiva de doble cara y pegue la junta.



PREPARACIÓN DE LA PARTE INTERIOR DE LA PISCINA

La distribución del geotextil empieza desde la parte interior de las paredes de la piscina. Para la instalación, se debe utilizar cinta adhesiva de doble cara o pegamento. Prepare los agujeros para el skimmer y las boquillas.

Cortar los perfiles de PVC en las dimensiones indicadas en el manual. Preste atención a los ángulos requeridos. De acuerdo con el diagrama, prepare los agujeros \varnothing 2 mm. Monte los perfiles a la estructura conectándolos a lo largo de toda la piscina. Planifique la distribución de perfiles para hacer la menor cantidad de juntas posible.

Extienda el geotextil uniformemente sobre el suelo de la piscina, luego comience a instalar el revestimiento (lámina de la piscina/liner) con perfiles de PVC.

Se recomienda almacenar el forro en su embalaje original en una habitación seca a una temperatura ambiente moderada (15-25 grados centígrados). Temperaturas cálidas hacen que el material del revestimiento sea más manejable.

Al instalar el revestimiento en la estructura de la piscina, asegúrese de que las uniones y soldaduras estén perfectamente distribuidas en las esquinas de las paredes. Alisa todos los pliegues. Preste atención a los lugares donde van ubicados los orificios para lámpara, boquilla y skimmer.

Introduce el liner dentro de los perfiles de PVC utilizando el liner lock.

Al verter agua, endereza el revestimiento en el suelo con los pies descalzos, nivela cualquier desnivel que pueda tener y al mismo tiempo estira las paredes del revestimiento hasta el suelo (presta mucha atención a las esquinas).

El agua de la piscina debe verterse gradualmente, como se indica en el manual.



SISTEMA DE FILTRACIÓN

Detenga el nivel de agua 5-10 cm antes de llegar a la altura de la boquilla y corte el orificio de acuerdo con el dibujo del manual.

Para la instalación de la boquilla, cubra el revestimiento que mira hacia el lado de la junta con vaselina, asegure la rosca del conector de la manguera con cinta de teflón y conecte la manguera a la boquilla, luego apriete con el clip de la manguera. Ajuste suavemente el clip de la manguera para no romper la abrazadera. Esté atento a cualquier fuga. Si la hubiese, aplique más cinta adhesiva y apriete la abrazadera.

Llene la mitad del tanque del filtro con agua. La otra mitad se debe llenar con la arena que encontrás en el kit.

Montaje del sistema de filtración: válvula, abrazadera de brida, manómetro. Cubra la rosca de los conectores de la manguera con teflón.

Conecte los elementos del sistema de filtración de acuerdo con las pautas que se muestran en el manual de su modelo de piscina.

Después de completar este paso, siga llenando de agua.



INSTALACIÓN DEL SKIMMER

Deje de verter agua cuando el nivel del agua esté 5-10 cm por debajo del skimmer, para realizar un agujero en el lugar del skimmer.

Antes, asegúrese de hacer un agujero en el material geotextil.

Coloque el marco del skimmer y enrósquelo suavemente en skimmer a través del revestimiento. No corte el revestimiento antes de atornillar el marco, el corte puede cambiar y el orificio puede no ajustarse al marco cuando está atornillado.

Corte el agujero, luego retire el marco y coloque todos los elementos del skimmer en su lugar de acuerdo con el dibujo del manual.

Asegúrese de conectar todos los elementos filtrantes con mangueras de acuerdo con las instrucciones y continúe llenando de agua.

Para garantizar el correcto funcionamiento del conjunto de filtros, debe llenar la piscina hasta la mitad del skimmer.



INSTALACIÓN DE LOS TABLEROS DEL CORONAMIENTO

Coloque las tablas de acuerdo con el diagrama presentado en el manual de instalación.

Para montar la tabla móvil (para facilitar el acceso al skimmer), utilice las bisagras incluidas en el kit.



Los conectores de madera de las esquinas se adhieren a la parte inferior de los tableros.

Es recomendable instalar los tableros del coronamiento una vez la piscina está llena de agua. Por razones estéticas, se recomienda quitar y volver a colocar los tableros dentro de 1-2 semanas desde el llenado de la piscina.

Preste atención a la distribución uniforme de los tornillos.

Después de completar la instalación de los tableros, proceda con la instalación de las escaleras externas y la escalera interna.

OPCIÓN → Si la piscina tiene cantoneras de inoxidable como opcional, realiza la instalación como se indica en el manual.

Leggere le istruzioni e il manuale d'uso prima dell'installazione!

QR CODE per La Guida



EN

PL

FR

DE



PRIMA DEL MONTAGGIO

Le istruzioni in Suo possesso mostrano passo dopo passo come installare correttamente la piscina. Abbiamo fatto ogni sforzo per preparare materiali che riflettano il più possibile lo stato e l'aspetto reale dei vari elementi. Tuttavia, si prega di notare che tutti i disegni sono solo a scopo illustrativo ed è possibile che i singoli elementi forniti nel Suo set possano in effetti differire nell'aspetto dalla loro visualizzazione grafica contenuta nelle istruzioni.

Si attenga alle regole per un uso sicuro della piscina!

Prima dell'installazione, conservare il pacchetto in un luogo asciutto con un adeguato flusso d'aria e proteggerlo dagli agenti atmosferici nocivi (luce solare, precipitazioni). Non conservare sotto copertura in un luogo esposto alla luce diretta del sole. Conservare con cura i componenti in legno non imballati, senza esporli alla luce diretta del sole o all'acqua.

Eeguire il montaggio entro 3 giorni dal disimballaggio della struttura.



Per proteggere il legno dai fattori atmosferici, si consiglia di rifinire la superficie in legno della piscina con preparati destinati alla protezione delle strutture esterne realizzate con questo materiale (per esempio, la vernice ad olio disponibile nella nostra offerta attuale - prodotto appositamente progettato per una protezione efficace delle piscine in legno). La manutenzione della piscina deve essere effettuata almeno una volta all'anno, e nel caso delle piscine esposte a condizioni climatiche estreme anche più spesso.

La mancata manutenzione annuale della struttura comporterà l'annullamento della garanzia!



Prima dell'installazione, controllare attentamente il numero di componenti e l'assenza di danneggiamenti. I singoli raccordi indicati nelle istruzioni possono differire leggermente da quelli effettivamente forniti. Qualsiasi difetto o danno deve essere segnalato prima dell'installazione.



Preparare gli strumenti necessari indicati nelle istruzioni - gli strumenti non sono inclusi nel kit.



TAPPO DELL'UGELLO

Per preparare la piscina alla stagione invernale (soprattutto se c'è il rischio di congelamento dell'acqua), utilizzare un tappo per gli ugelli di afflusso al fine di interrompere l'alimentazione dell'acqua verso il gruppo filtrante. Lasciare l'ugello nella piscina, montare il tappo sott'acqua. Ricordarsi anche di scollegare il gruppo filtrante dalla fonte d'acqua e di asciugare bene l'ugello dall'esterno. Si consiglia anche di rimuovere l'acqua residua dalla pompa e dal filtro a sabbia annesso durante il periodo invernale (località a rischio di gelo). In caso contrario, l'acqua gelata può distruggere l'intero set.



PREPARAZIONE DEL SUBSTRATO

La struttura di una piscina interamente o parzialmente interrata deve essere protetta secondo le indicazioni riportate nelle istruzioni.

È necessaria una protezione secondo il disegno presente nelle istruzioni:

- 1 - FONDAZIONE DELLA PISCINA**
- 2 - TUBO DI DRENAGGIO**
- 3 - MEMBRANA A BOLLE PER FONDAZIONI**
- 4 - GHIAIA**
- 5 - GEOTESSILE**
- 6 - TERRENO**

Per delimitare l'area per la piscina, stendere un primo strato, destinato alla successiva rimozione, per preparare il terreno.

Durante le operazioni di delimitazione dell'area per la piscina, rimuovere l'erba, le radici e le pietre.

Il substrato per la piscina deve essere solido, piatto e livellato!

Nel caso di piscine senza supporti in acciaio - utilizzare sabbia stabilizzata con cemento (strato - 2 cm) o massetto di cemento.

Nel caso di una piscina con supporti in acciaio - la base dello scavo / massetto in cemento deve essere preparata secondo lo schema riportato nelle istruzioni.

Le linee guida per il posizionamento dei montanti 2T e la preparazione dell'armatura per il massetto devono essere rigorosamente rispettate. Tutte le dimensioni devono essere in accordo con le linee guida presenti nel manuale.

Raccomandiamo che il massetto di cemento sia eseguito da aziende specializzate.



INSTALLAZIONE DELLA STRUTTURA IN LEGNO

Iniziare l'installazione della struttura con il primo strato.

Controllare le diagonali dopo la posa di ogni strato. Le dimensioni dovranno corrispondere a quelle indicate nelle istruzioni.

Quando si installano gli strati successivi, utilizzare il martelletto fornito con gli elementi in legno della struttura. Non è consentito l'impatto diretto sui componenti destinati a formare il collegamento a incastro. Il danno risultante rende impossibile l'assemblaggio dei componenti o ne indebolisce la forza.

Continuare ad assemblare i vari elementi in legno nell'ordine indicato nelle istruzioni.

OPZIONE → Se la Sua piscina ha un'opzione di illuminazione, installare la lampada nella struttura della piscina secondo le istruzioni aggiuntive fornite con la lampada.



PREPARAZIONE DELLO SKIMMER

Assemblare i singoli componenti che formano lo skimmer completo, mettendo in sicurezza le filettature con nastro di teflon.

Attenzione!

Il tempo di installazione dello skimmer nella struttura in legno dipende dal modello dello skimmer. Eseguire questo passo secondo le linee guida riportate nelle istruzioni della tua piscina.

Lo skimmer deve essere avvitato nella fase appropriata e nei punti indicati.

Durante l'installazione, le superfici del diffusore devono essere coperte con nastro biadesivo e la guarnizione deve essere incollata in posizione.



PREPARAZIONE DELL'INTERNO DELLA PISCINA

Installare il geotessile usando nastro biadesivo o colla. Iniziare con le pareti interne della piscina. Preparare i fori per lo skimmer e gli ugelli nel geotessile uniformemente distribuito.

Tagliare i profili per il fissaggio della membrana per la piscina alle dimensioni indicate, assicurandosi di mantenere gli angoli richiesti. Eseguire dei fori da \varnothing 2 mm nei profili come mostrato. Successivamente, montare i profili sulla struttura, unendoli intorno al perimetro della piscina. Ricordare che i profili sono uniti nel senso della lunghezza. Pertanto, la loro distribuzione deve prevedere il minor numero di giunzioni possibile.

Stendere il geotessile in modo uniforme sulla base della piscina e iniziare l'installazione del liner (membrana per la piscina) nei profili in PVC.

Conservare la membrana per la piscina imballata in un luogo asciutto, a una temperatura ambiente di 15-25 gradi, prima dell'installazione. La temperatura calda renderà il materiale più facile da montare e installare nella struttura

Adattare con cura gli angoli della membrana per piscine agli angoli della piscina. Spianare tutte le pieghe. Fare attenzione alle aree intorno ai fori per la lampada, l'ugello, lo skimmer.

Installare la membrana della piscina nei profili in PVC premendo con la guarnizione (tappo).

Mentre si versa l'acqua, stendere la membrana (liner) sul terreno con i piedi nudi, appianare le irregolarità, tendendo contemporaneamente le pareti al suolo (prestare particolare attenzione agli angoli).

L'acqua della piscina deve essere introdotta gradualmente come indicato nelle istruzioni.



SISTEMA DI FILTRAGGIO

Fermare il riempimento dell'acqua 5-10 cm prima della posizione destinata all'ugello e tagliare il foro per l'ugello come indicato nelle istruzioni.

Lubrificare le guarnizioni sul lato del liner con vaselina, attaccare gli ugelli, coprire le filettature degli ugelli con nastro di teflon. Successivamente, attaccare il tubo all'ugello e fissarlo con fascette a vite. Regolare la pressione facendo attenzione a non rompere la fascetta, osservare che non vi siano perdite. Se non c'è tenuta, applicare altro nastro e stringere la fascetta.

Riempire il serbatoio del filtro fino a metà con acqua. Riempire l'altra metà del serbatoio del filtro con la sabbia inclusa nel kit.

Montare il gruppo filtrante composto da valvola, morsetto e manometro. Coprire i raccordi dei tubi con del nastro di teflon, sia sulla filettatura che sul raccordo del tubo.

Collegare i componenti del sistema di filtraggio secondo le istruzioni del modello acquistato.

Continuare a riempire con acqua dopo questa fase



INSTALLAZIONE DELLO SKIMMER

Smettere di versare l'acqua quando il suo livello raggiungerà 5-10 cm al di sotto del luogo designato per lo skimmer, al fine di realizzare un buco nella membrana per questo dispositivo. Ricordarsi di realizzare anticipatamente i fori nel geotessile sotto alla membrana della piscina.

Montare il telaio dello skimmer all'interno e avvitare delicatamente alla parte esterna dello skimmer attraverso il liner per rendere più facile segnare la posizione del taglio. Non tagliare il liner prima di avvitare il telaio Il taglio, infatti, potrebbe spostarsi e il foro fatto potrebbe non adattarsi dopo l'avvitamento del telaio.

Tagliare il foro, poi rimuovere il telaio, installando gli altri elementi dello skimmer al suo posto. Guarnizione, telaio e maschera. Attenersi all'illustrazione presente nelle istruzioni.

Assicurarsi di aver collegato tutti gli elementi di filtraggio con i tubi secondo le istruzioni e continuare a riempire d'acqua.

Per garantire il corretto funzionamento del gruppo filtrante, integrare il livello dell'acqua della piscina fino a metà dello skimmer!



INSTALLAZIONE DELLE TAVOLE DI DECKING

Posare le tavole di decking della piscina secondo lo schema riportato nelle istruzioni.

Usare le cerniere incluse per montare la tavola mobile di accesso allo skimmer.



Installare i connettori angolari sul lato inferiore delle tavole di decking.

Per migliorare l'estetica, si raccomanda di rimuovere e riposizionare le tavole di decking entro 1-2 settimane dal riempimento della piscina.

Assicurarsi che le viti per il decking siano uniformemente distanziate.

Una volta che le tavole di decking saranno state posate, procedere con l'installazione delle scale esterne e della scaletta interna.

OPZIONE → Se la Sua piscina ha l'opzione delle maschere angolari, eseguite la loro installazione come indicato nelle istruzioni.

Před zahájením montáže si přečtěte návod a uživatelskou příručku!

QR KÓD pro příručku USER GUIDE



EN

PL

FR

DE



PŘED MONTÁŽÍ

Návod, který držíte v rukou, vám krok za krokem předvede, jak bazén správně smontovat. Vynaložili jsme veškeré úsilí na přípravu materiálů, které co nejméně odrážejí skutečný stav a vzhled jednotlivých prvků. Upozorňujeme však, že všechny obrázky jsou pouze ilustrativní a je možné, že se jednotlivé prvky dodané ve vaší sadě budou ve skutečnosti vzhledově lišit od jejich grafického znázornění uvedeného v návodu.

Dodržujte, prosím, pravidla bezpečného používání bazénu!

Před instalací skladujte sadu na suchém místě s dostatečným prouděním vzduchu a chraňte ji před škodlivými povětrnostními vlivy (sluneční záření, srážky). Neskladujte pod krytem na slunném místě. Rozbalené dřevěné součásti pečlivě skladujte, aniž by byly vystaveny přímému slunečnímu záření nebo vodě.

Montáž by měla být provedena do 3 dnů od vybalení konstrukce.



Pro ochranu dřeva před povětrnostními vlivy doporučujeme ošetřit dřevěný povrch bazénu přípravky určenými k ochraně vnějších dřevěných konstrukcí (například olejovou lazurou, která je k dispozici v naší aktuální nabídce, jedná se o přípravek speciálně určený k účinné ochraně dřevěných bazénů). Údržbu bazénu provádějte alespoň jednou ročně, a v případě bazénů vystavených extrémním povětrnostním podmínkám i častěji.

Neprovádění každoroční údržby bude mít za následek ztrátu záruky!



Před montáží pečlivě zkontrolujte počet všech součástí a zda nejsou poškozeny. Skutečně dodané příslušenství se může mírně lišit od příslušenství popsaného v návodu. Jakékoli nedostatky nebo poškození je třeba nahlásit před montáží.



Připravte si potřebné nástroje a nářadí uvedené v návodu. Nářadí a nástroje nejsou součástí balení.



ZÁTKA PRO TRYSKU

Za účelem přípravy bazénu na zimní sezónu (zejména pokud existuje riziko zamrznutí vody) použijte zátku pro přívodní trysku, která přeruší přívod vody do filtrační soupravy. Trysku ponechte v bazénu, zátku namontujte pod vodou. Nezapomeňte také na odpojení filtrační soupravy od zdroje vody a důkladné osušení trysky zvenčí. V rámci přípravy na zimní období (v oblastech, kde se vyskytují mrazy) je rovněž vhodné odstranit z čerpadla a z přiloženého pískového filtru zbytky vody, jinak by mrznoucí voda mohla způsobit zničení celé soupravy.



PŘÍPRAVA PODKLADU

Bazén zcela nebo částečně zapuštěný do země musí být chráněn v souladu s pokyny uvedenými v návodu.

Je vyžadována ochrana podle obrázku v návodu:

- 1 - ZÁKLADY BAZÉNU**
- 2 - DRENÁŽNÍ TRUBKA**
- 3 - ZÁKLADOVÁ BUBLINKOVÁ FÓLIE**
- 4 - ŠTĚRK**
- 5 - GEOTEXILIE**
- 6 - ZEMINA**

Za účelem vytyčení bazénu položte první vrstvu, kterou pak odstraňte, aby se připravil prostor.

Při vytyčování bazénu odstraňte trávu, kořeny a kameny.

Místo pro stavbu bazénu musí být na pevném a rovném podkladu, plocha pod bazénem musí být vodorovná!

Pro bazén bez ocelových podpěr použijte písek stabilizovaný cementem (vrstvu 2 cm) nebo betonový potěr.

V případě bazénu s ocelovými podpěrami musí být podklad výkopu / betonového potěru připraven v souladu se schématem znázorněným v návodu.

Pokyny pro umístění sloupků 2T a přípravu výztuže pod potěr musí být striktně dodržovány, všechny rozměry musí být v souladu s pokyny uvedenými v návodu.

Doporučujeme, aby betonový potěr provedla specializovaná firma.



MONTÁŽ DŘEVĚNÉ KONSTRUKCE

Montáž konstrukce zahájte položením první vrstvy.

Po položení každé vrstvy kontrolujte úhlopříčky, rozměry musí odpovídat údajům uvedeným v návodu.

Během montáže dalších vrstev použijte příklepový blok dodaný spolu s dřevěnými prvky konstrukce. Je nepřijatelné přímo tlouci do součásti pera nebo drážky. Takto vzniklá poškození znemožňují sestavení součástí nebo oslabují jejich pevnost.

Pokračujte v montáži jednotlivých dřevěných prvků v pořadí uvedeném v návodu.

VOLBA → Pokud je váš bazén vybaven osvětlením, namontujte lampu do bazénu v souladu s dodatečným návodem přiloženým k lampě.



PŘÍPRAVA SKIMMERU

Smontujte jednotlivé součásti do kompletního skimmeru a obalte závity teflonovou páskou.

Upozornění!

Okamžik, kdy by se měl skimmer montovat do dřevěné konstrukce, závisí na modelu skimmeru. Tento krok proveďte podle pokynů uvedených v návodu vašeho bazénu.

Skimmer přišroubujte v příslušném kroku a na uvedených místech.

Během montáže omotejte plochy difuzoru oboustrannou páskou a přilepte těsnění.



PŘÍPRAVA VNITŘNÍ STRANY BAZÉNU

Proveďte montáž geotextilie pomocí oboustranné lepicí pásky nebo lepidla. Začněte od vnitřních stěn bazénu. V rovnoměrně rozložené geotextilii připravte otvory pro skimmer a trysky.

Profily pro upevnění bazénové fólie nařežte na uvedené rozměry, dbejte přitom na zachování požadovaných úhlů. Do profilů vyvrtejte otvory \varnothing 2 mm podle schématu. Pak připevněte profily ke konstrukci a spojte je po celém obvodu bazénu. Nezapomeňte, že se profily spojují podélně, naplánujte tedy jejich uspořádání tak, aby bylo co nejméně spojů.

Geotextilii rovnoměrně rozprostřete na podklad bazénu, a pak začněte s montáží lineru (bazénové fólie) do PVC profilů.

Před instalací skladujte zabalenou bazénovou fólii na suchém místě při pokojové teplotě 15 až 25 stupňů Celsia. Teplo způsobuje, že se materiál snáze přizpůsobí konstrukci a jeho montáž bude jednodušší.

Pečlivě přizpůsobte rohy bazénové fólie rohům bazénu. Vyhladte všechny záhyby. Věnujte pozornost místům kolem otvorů pro lampu, trysku a skimmer.

Namontujte bazénovou fólii do PVC profilů a přitlačte ji těsněním.

Během napouštění vody rozprostřete bazénovou fólii na podkladu bosýma nohama, vyrovnejte případné nerovnosti a zároveň natáhněte stěny k zemi (zvláštní pozornost věnujte rohům).

Vodu v bazénu napouštějte postupně podle pokynů uvedených v návodu.



FILTRAČNÍ SYSTÉM

Zastavte napouštění vody 5 - 10 cm před místem určeným pro trysku a vyřízněte otvor pro trysku podle obrázku v návodu.

Těsnění na straně lineru namažte vazelínou, nasadte trysku, závit trysky omotejte teflonovou páskou, pak připojte hadici k trysce a zašroubujte šnekovými sponami. Přítlak používejte opatrně, aby nedošlo ke stržení spony, a sledujte, zda nedochází k úniku. Pokud není zajištěna těsnost, použijte větší množství pásky a utáhněte sponu.

Naplňte nádrž filtru do poloviny vodou. Druhou polovinu nádrže filtru naplňte pískem, který je součástí sady.

Smontujte filtrační soupravu, která se skládá z ventilu, svorky a měřiče tlaku. Konektory pro připojení hadic omotejte teflonovou páskou, a to jak závit, tak i hadicové přípojky.

Součásti filtračního systému propojte podle návodu k vašemu modelu.

Po tomto kroku pokračujte v napouštění vody



MONTÁŽ SKIMMERU

Zastavte napouštění vody, když její hladina dosáhne 5 - 10 cm pod místo určené pro skimmer, abyste mohli ve fólii vyříznout otvor pro skimmer. Nezapomeňte předem vyříznout otvory v textilií pod bazénovou fólií.

Přizpůsobte rámeček skimmeru zevnitř a jemně jej přišroubujte k vnější části skimmeru skrz liner, abyste mohli snáze určit místo výřezu. Před přišroubováním rámečku liner neřežte, řez by se mohl posunout a vyříznutý otvor by se nemusel hodit po přišroubování rámečku.

Vyřízněte otvor, poté odstraňte rámeček a na jeho místo nainstalujte další prvky skimmeru. Těsnění, rámeček a clonku. Tyto kroky proveďte podle obrázku v návodu.

Ujistěte se, že jste všechny prvky filtrace propojili s hadicemi podle návodu, a pokračujte v napouštění vody.

Pro zajištění správné funkce filtrační soupravy dopouštěte hladinu vody v bazénu do poloviny skimmeru!



MONTÁŽ TERASOVÝCH DESEK

Umístěte terasové desky bazénu podle schématu uvedeného v návodu.

K montáži pohyblivé desky pro přístup ke skimmeru využijte závěsy přiložené k sadě.



Na spodní stranu terasových desek namontujte rohové spojky.

Pro zlepšení estetiky se doporučuje odstranit a znovu položit terasové desky během 1 až 2 týdnů po napuštění bazénu.

Ujistěte se, že jsou terasové vruty rovnoměrně rozmístěny.

Po dokončení montáže terasových desek začněte s montáží vnějšího schodiště a vnitřního žebříku.

VOLBA → Pokud je váš bazén vybaven kryty rohů, namontujte je podle návodu.

Antes de iniciar a montagem, leia o manual e o guia do usuário!

QR CODE para o Guia



EN

PL

FR

DE



ANTES DA MONTAGEM

As instruções em sua mão mostram passo a passo como montar corretamente a piscina. Fizemos todos os esforços para preparar materiais que refletem os fatos e a aparência de elementos individuais o mais fielmente possível. No entanto, lembre-se de que todos os desenhos são ilustrativos e é possível que os elementos individuais fornecidos em seu conjunto possam de fato diferir de sua visualização gráfica contida no manual.

Siga as regras de uso seguro da piscina!

Antes da instalação, guarde a embalagem em local seco e arejado, protegendo-a dos efeitos nocivos das condições climáticas (sol, chuva). Não guardar sob incidência da luz solar direta. Guarde as peças de madeira embaladas com cuidado, sem serem expostas à luz solar direta ou água.

A montagem deve ser realizada dentro de 3 dias após a desembalagem da estrutura.



A fim de proteger a madeira das intempéries, recomendamos o acabamento da superfície de madeira da piscina com preparações destinadas à proteção de estruturas externas de madeira (por exemplo, esmalte de óleo disponível na oferta atual da empresa - um produto especialmente desenvolvido para a proteção eficaz de piscinas de madeira). A manutenção da piscina deve ser realizada pelo menos uma vez por ano, e no caso de piscinas sujeitas a condições meteorológicas extremas, até mais frequentemente.

A falta de manutenção anual da estrutura anula a garantia!



Antes da montagem verifique cuidadosamente a quantidade e se os elementos não estão danificados. Os acessórios individuais no manual podem ser ligeiramente diferentes dos realmente entregues. Quaisquer deficiências ou danos devem ser relatados antes da montagem.



Prepare as ferramentas necessárias indicadas nas instruções – as ferramentas não estão incluídas no kit.



TAMPÃO DO BOCAL

Para preparar a piscina para o inverno (especialmente quando há risco de congelamento da água), use o tampão do bocal de entrada, que corta o fornecimento de água para o conjunto do filtro. Deixe o bocal na piscina, coloque a tampa embaixo d'água. Lembre-se de desconectar o conjunto de filtros da fonte de água e secar bem o bocal pelo lado de fora. Também é recomendável remover a água residual da bomba e do filtro de areia acoplado durante o inverno (onde ocorrem geadas), caso contrário, a água congelada pode destruir todo o conjunto.



PREPARAÇÃO DO FUNDO

A estrutura da piscina total ou parcialmente enterrada no solo deve ser fixada de acordo com as orientações contidas no manual.

A proteção é necessária de acordo com o desenho do manual:

- 1 – BASE DA PISCINA**
- 2 – TUBO DE DRENAGEM**
- 3 – PLÁSTICO BOLHA DA BASE**
- 4 – CASCALHO**
- 5 - GEOTÊXTIL**
- 6 - PISO**

Para marcar a área para a piscina, colocar uma primeira camada, que será depois removida para preparar o terreno.

Ao marcar a área da piscina, remova a grama, as raízes e as pedras.

O piso para a piscina deve ser firme, plano e nivelado!

No caso de piscinas sem suportes de aço, utilizar areia estabilizada com cimento (camada - 2 cm) ou betonilha de concreto.

No caso de piscina com suportes de aço, a base da escavação / betonilha de betão deve ser preparada de acordo com o diagrama apresentado nas instruções.

As orientações para a disposição dos postes 2T e preparação das armaduras para a mesa devem ser rigorosamente seguidas, todas as dimensões devem estar de acordo com as orientações contidas no manual.

Recomendamos que a betonilha de concreto seja executada por empresas especializadas.



MONTAGEM DA ESTRUTURA DE MADEIRA

Comece a montagem da estrutura com o assentamento da primeira camada.

Verifique as diagonais após o assentamento de cada camada, as dimensões devem estar de acordo com as dimensões indicadas nas instruções.

Durante a montagem das camadas subsequentes, deve-se utilizar o bloco macho fornecido com os elementos de madeira da estrutura. Não é permitido acertar os elementos macho ou fêmea diretamente. O dano resultante impede a montagem dos elementos ou reduz a sua resistência.

Continue montando as peças individuais de madeira na ordem mostrada nas instruções.

OPÇÃO → Se a sua piscina tiver a opção de iluminação, instale a lâmpada na estrutura da piscina de acordo com as instruções adicionais anexadas à lâmpada.



PREPARAÇÃO DO SKIMMER

Monte os elementos individuais para formar um skimmer completo, prendendo os fios com fita de Teflon.

Atenção!

O momento de montagem do skimmer na estrutura de madeira depende do respectivo modelo. Execute esta etapa de acordo com as instruções do manual da sua piscina.

O skimmer deve ser aparafusado no estágio apropriado e nos locais indicados.

Durante a montagem, cubra as superfícies do difusor com fita dupla-face e cole a gaxeta.



PREPARAÇÃO DA PARTE INTERIOR DA PISCINA

Coloque o geotêxtil com fita adesiva dupla-face ou cola. Comece pelas paredes internas da piscina. No geotêxtil uniformemente distribuído, prepare orifícios para o skimmer e os bocais.

Corte os perfis para fixação da lona da piscina nas dimensões indicadas, observando os ângulos requeridos. Fazer furos de 2 mm Ø nos perfis, como mostrado. Em seguida, monte os perfis na estrutura, conectando-os em todo o perímetro da piscina. Lembre-se de que os perfis são unidos longitudinalmente, planeje sua distribuição de forma a fazer o mínimo de juntas possível.

Distribua o geotêxtil uniformemente no piso da piscina e, em seguida, comece a colocar o liner (película da piscina) nos perfis de PVC.

Antes da montagem, guarde o forro da piscina embalado em um local seco a uma temperatura ambiente entre 15 a 25 graus Celsius. A temperatura aquecida torna o material mais fácil de encaixar e instalar na estrutura

Alinhe os cantos do forro exatamente com os cantos da piscina. Suavize todas as dobras. Preste atenção aos locais próximos aos orifícios da lâmpada, do bocal e do skimmer.

Instale a lona da piscina nos perfis de PVC, pressionando-a com um lacre (rolha).

Ao despejar água, espalhe a lona no solo com os pés descalços, nivele eventuais desníveis, enquanto estica as paredes até o solo (com atenção especial aos cantos).

A água da piscina deve ser reabastecida gradualmente conforme indicado nas instruções.



SISTEMA FILTRANTE

Pare de reabastecer com água de 5 a 10 cm antes do bocal designado e faça um orifício logo abaixo dele, conforme mostrado na figura do manual.

Pincele as gaxetas com vaselina no lado do revestimento, fixe os bocais, cubra a rosca do bocal com fita de Teflon, em seguida, prenda a mangueira ao bocal e aperte com faixas em espiral. Ajuste a pressão suavemente para não quebrar a braçadeira, observe se há vazamento. Se não houver vazamento, aplique mais fita e aperte a braçadeira.

Encha o tanque do filtro até a metade com água. Encha a outra metade do tanque do filtro com a areia fornecida com o kit.

Monte o conjunto de filtros composto pela válvula, grampo e manômetro. Cubra os acoplamentos para conectar as mangueiras com fita de Teflon na rosca e nos pontos de conexão da mangueira.

Conecte os elementos do sistema de filtragem de acordo com as instruções do seu modelo.

Continue a encher com água após esta etapa



MONTAGEM DO SKIMMER

Pare de encher com água quando o nível estiver de 5 a 10 cm abaixo do local do skimmer, para cortar o orifício do skimmer no plástico. Lembre-se de fazer furos na fibra sob a lona da piscina com antecedência.

Alinhe a estrutura do skimmer por dentro e rosqueie suavemente do lado de fora deste, através do forro para facilitar a marcação do local do recorte. Não corte o revestimento antes de aparafusar a moldura, o entalhe pode se deslocar e o orifício feito pode não encaixar após aparafusar a moldura.

Corte o orifício, remova a estrutura e instale os próximos elementos do skimmer em seu lugar. Junta, moldura e máscara. Execute as etapas de acordo com a imagem do manual.

Certifique-se de conectar todos os elementos do filtro com mangueiras de acordo com as instruções e continue enchendo com água.

Para garantir o funcionamento adequado do conjunto de filtros, aumente o nível da água na piscina até a metade do skimmer!



MONTAGEM DOS DECKS

Coloque o deck da piscina de acordo com o diagrama apresentado no manual.

Para montar a prancha móvel que dá acesso ao skimmer, utilize as dobradiças que acompanham o conjunto.



Monte os conectores de canto na parte inferior dos decks.

Para melhorar a estética, é recomendado remover e reorganizar os decks dentro de 1 a 2 semanas após o enchimento da piscina.

Preste atenção à distribuição uniforme dos parafusos do deck.

Depois de concluída a montagem dos decks, proceda à instalação das escadas externas e internas.

OPÇÃO → Se a sua piscina tem a opção de coberturas de canto, instale-as de acordo com as instruções.

Pred inštaláciou si prečítajte návod na použitie a používateľskú príručku!

QR KÓD pre Sprievodcu



EN

PL

FR

DE



PRED INŠTALÁCIU

Návod vo vašej ruke ukazuje krok za krokom, ako bazén správne zostaviť. Vynaložili sme maximálne úsilie, aby sme pripravili materiály, ktoré čo najvernejšie odrzkadľujú skutočnosti a vzhľad jednotlivých prvkov. Pamätajte však, že všetky nákresy sú ilustračné a existuje možnosť, že jednotlivé prvky dodávané vo vašej súprave sa môžu v skutočnosti líšiť od ich grafickej vizualizácie obsiahnutej v návode.

Dodržiavajte pravidlá bezpečného používania bazéna!

Balenie pred montážou skladujte na suchom mieste, ktoré zabezpečuje správne prúdenie vzduchu, chráňte ho pred škodlivými vplyvmi poveternostných vplyvov (slnečné žiarenie, zrážky). Neskladujte pod krytom na priamom slnku. Zabalené drevené časti starostlivo skladujte bez toho, aby boli vystavené priamemu slnečnému žiareniu alebo vode.

Inštalácia by mala byť vykonaná do 3 dní od rozbalenia konštrukcie.



Pre ochranu dreva pred poveternostnými vplyvmi odporúčame povrchovú úpravu bazéna upraviť prípravkami určenými na ochranu vonkajších drevených konštrukcií (napríklad olejová lazúra dostupná v aktuálnej ponuke firmy – prípravok špeciálne vyvinutý pre účinnú ochranu drevených bazénov). Údržba bazénov by sa mala vykonávať aspoň raz ročne, v prípade bazénov vystavených extrémnym poveternostným podmienkam ešte častejšie.

Nedostatočná ročná údržba konštrukcie ruší záruku!



Pred montážou dôkladne skontrolujte množstvo prvkov a či nie sú poškodené. Jednotlivé príslušenstvo v návode sa môže mierne líšiť od skutočne dodaného. Akékoľvek nedostatky alebo poškodenia je potrebné nahlásiť pred inštaláciou.



Pripravte si potrebné nástroje uvedené v návode – nástroje nie sú súčasťou súpravy.



ZÁTKA DO TRYSKY

Pre prípravu bazéna na zimnú sezónu (hlavne pri nebezpečenstve zamrznutia vody) použite zátku prívodných trysiek, ktorá preruší prívod vody do filtračnej súpravy. Nechajte trysku v bazéne, nainštalujte zástrčku pod vodu. Nezabudnite tiež odpojiť súpravu filtrov od prívodu vody a dôkladne vysušiť trysku zvonku. Taktiež sa odporúča počas zimy (miesta, kde sa vyskytuje mráz) odstraňovať zvyškovú vodu z čerpadla a na ňom pripevneného pieskového filtra, inak môže mrznúca voda zničiť celú zostavu.



PRÍPRAVA PODKLADU

Konštrukcia bazéna, ktorá je úplne alebo čiastočne zapustená do zeme, musí byť zabezpečená v súlade s pokynmi obsiahnutými v príručke.

Vyžaduje sa ochrana, ako je znázornené na výkrese v príručke:

- 1 – ZÁKLAD BAZÉNA**
- 2 – DRENÁŽNE POTRUBIE**
- 3 – BUBLINOVÁ ZÁKLADOVÁ FÓLIA**
- 4 – ŠTRK**
- 5 – GEOTEXTÍLIE**
- 6 – PÔDA**

Aby ste vymedzili plochu pre bazén, urobte prvú vrstvu, ktorú potom odstráňte, aby ste plochu pripravili.

Pri označovaní priestoru pre bazén odstráňte trávu, korene a kamene.

Podklad pre bazén musí byť tvrdý, plochý a vyrovnaný!

V prípade bazéna bez oceľových podpier – použite piesok stabilizovaný cementom (vrstva – 2 cm) alebo betónový poter.

V prípade bazénu s oceľovými podperami – základ výkopu / betónový poter musí byť pripravený v súlade so schémou uvedenou v návode.

Pokyny pre usporiadanie 2T stĺpikov a prípravu výstuže pre poter musia byť prísne dodržané, všetky rozmery musia byť v súlade s pokynmi obsiahnutými v návode.

Betónový poter odporúčame zhotoviť špecializovaným firmám.



MONTÁŽ DREVENEJ KONŠTRUKCIE

Montáž konštrukcie začnite položením prvej vrstvy.

Po položení každej vrstvy skontrolujte uhlopriečky, rozmery musia zodpovedať rozmerom uvedeným v návode.

Pri montáži ďalších vrstiev by sa mal použiť priebojník dodávaný s drevenými prvkami konštrukcie. Priamy náraz do prvkov pera alebo vpustu nie je povolený. Výsledné poškodenie bráni montáži prvkov alebo znižuje ich pevnosť.

Pokračujte v montáži jednotlivých kusov dreva v poradí uvedenom v návode.

OPCIA → Ak má váš bazén možnosť osvetlenia, nainštalujte lampu do konštrukcie bazéna v súlade s dodatočnými pokynmi priloženými k lampe.



PRÍPRAVA SKIMMERA

Zložte jednotlivé prvky tak, aby vytvorili kompletný skimmer, pričom závitý zaistíte teflónovou páskou.

Pozor!

Moment montáže skimmeru do drevenej konštrukcie závisí od modelu skimmeru. Vykonajte tento krok podľa pokynov v príručke k vášmu bazénu.

Skimmer by mal byť naskrutkovaný vo vhodnej fáze práce a na označených miestach.

Počas inštalácie prelepte povrchy difúzora obojstrannou páskou a prilepte tesnenie.



PRÍPRAVA VNÚTORNEJ STRANY BAZÉNU

Nainštalujte geotextíliu pomocou obojstrannej lepiacej pásky alebo lepidla. Začnite s vnútornými stenami bazéna. V rovnomerne rozloženej geotextílii pripravte otvory pre skimmer a trysky.

Profily na pripevnenie bazénovej fólie narežte na uvedené rozmery pri dodržaní požadovaných uhlov. Pre profily vyvrtajte otvory \varnothing 2 mm podľa schémy. Potom namontujte profily na konštrukciu a spojte ich po celom obvode bazéna. Nezabudnite, že profily sa spájajú pozdĺžne, naplánujte si ich rozmiestnenie tak, aby bolo spojov čo najmenej.

Geotextíliu rovnomerne rozmiestnite na základňu bazéna, potom začnite inštalovať fóliu (bazénovú fóliu) do PVC profilov.

Pred montážou skladujte zabalenú bazénovú fóliu na suchom mieste pri izbovej teplote 15-25 stupňov Celzia. Vysoká teplota uľahčuje montáž a inštaláciu materiálu do konštrukcie.

Rohy bazénovej fólie zarovnajte presne s rohmi bazéna. Vyhladujte všetky záhyby. Dávajte pozor na miesta v blízkosti otvorov pre lampu, trysku, skimmer.

Bazénovú fóliu nainštalujte do PVC profilov, zatlačte ju tesnením (zátkou).

Pri nalievaní vody rozložte liner na zem bosými nohami, vyrovnajte nerovnosti a zároveň natiahnite steny k zemi (pozor najmä na rohy).

Voda v bazéne by sa mala dopĺňať postupne, ako je uvedené v návode.



FILTRAČNÝ SYSTÉM

Zastavte dopĺňanie vody 5-10 cm pred určeným miestom pre trysku a vyrežte otvor pre trysku podľa nákresu v návode.

Tesnenia natrite vazelínou zo strany vložky, pripevníte trysky, prelepte závit trysky teflónovou páskou, potom nasadíte hadicu na trysku a utiahnite špirálovými páskami. Jemne upravte tlak, aby ste neporušili svorku, sledujte, či nedochádza k úniku. Ak nedochádza k úniku, nalepte viac pásky a utiahnite svorku.

Naplňte filtračnú nádrž do polovice vodou. Druhú polovicu filtračnej nádrže naplňte pieskom, ktorý je súčasťou súpravy.

Zostavte súpravu filtra pozostávajúcu z ventilu, svorky a manometra. Hadicové prípojky zakryte teflónovou páskou, a to na závit aj na hadicovej prípojke.

Pripojte prvky filtračného systému podľa pokynov pre váš model.

Po tomto kroku pokračujte v plnení vodou.



INŠTALÁCIA SKIMMERA

Keď hladina vody dosiahne 5 až 10 cm pod miestom určeným pre skimmer, prestaňte nalievať vodu a vyrežte vo fólii otvor pre skimmer. Nezabudnite v textílie pod bazénovou fóliou vopred vyrezať otvory.

Rám skimmera nasadíte z vnútornej strany a jemne ju priskrutkujete k vonkajšej strane skimmera cez vložku, aby ste mohli ľahšie označiť výrez. Pred naskrutkovaním rámu nenarežte vložku, rez sa môže posunúť a vytvorený otvor po naskrutkovaní rámu nemusí sedieť.

Vyrežte otvor, potom odstráňte rám a na jeho miesto nainštalujte ďalšie prvky skimmeru, tesnenie, rám a kryt. Vykonajte kroky, ako je znázornené na obrázku v príručke.

Uistite sa, že ste všetky filtračné prvky pripojili hadicami podľa návodu a pokračujte v plnení vodou.

Aby ste zabezpečili správnu funkciu filtračnej súpravy, doplňte hladinu vody v bazéne do polovice skimmeru!



MONTÁŽ TERASOVÝCH DOSIEK

Umiestnite terasové dosky bazéna podľa schémy uvedenej v návode.

Na zostavenie pohyblivej dosky, ktorá umožňuje prístup k skimmeru, použite pánty, ktoré sú súčasťou súpravy.



Nainštalujte rohové spojky zo spodnej strany terasových dosiek.

Na zlepšenie estetiky sa odporúča odstrániť a znovu položiť podlahové dosky do 1-2 týždňov od naplnenia bazéna.

Dbajte na rovnomerné rozmiestnenie podlahových skrutiek.

Po dokončení montáže podlahových dosiek pokračujte montážou vonkajších schodov a vnútorného rebríka.

OPCIA → Ak má váš bazén možnosť rohových krytov, nainštalujte ich podľa pokynov.

(PL) Instrukcja montażu

(GB) Assembly instructions

(DE) Montageanleitung

(FR) Notice de montage

(IT) Istruzioni di montaggio

(NL) Montage-instructies

Nazwa /Name /Name /Nom /Nome /Namm

OALL 3

UWAGA /REMARQUE/ /NOTE/ ATATTENZIONE /HINWEIS /LETOP

(PL) Maksymalna wysokość słupa wody ~ 1,20 m

(FR) Niveau maximum de la colonne d'eau ~ 1,20 m

(GB) The maximum water column level ~ 1,20 m

(IT) Livello massimo della colonna d'acqua ~ 1,20 m

(DE) Maximaler Wasserstand ~ 1,20 m

(NL) Maximum niveau waterkolom ~ 1,20 m

(PL) Objętość wody w basenie 25,45 m³

(FR) Le volume de l'eau dans la piscine 25,45 m³

(GB) Water capacity in the pool 25,45 m³

(IT) Il volume di acqua in piscina 25,45 m³

(DE) Volumen von Wasser im Schwimmbecken 25,45 m³

(NL) Water inhoud van het zwembad 25,45 m³

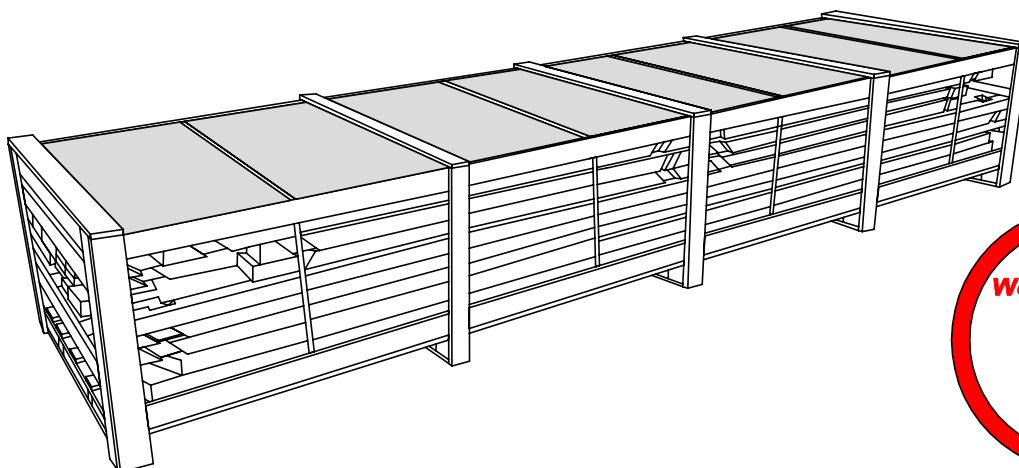
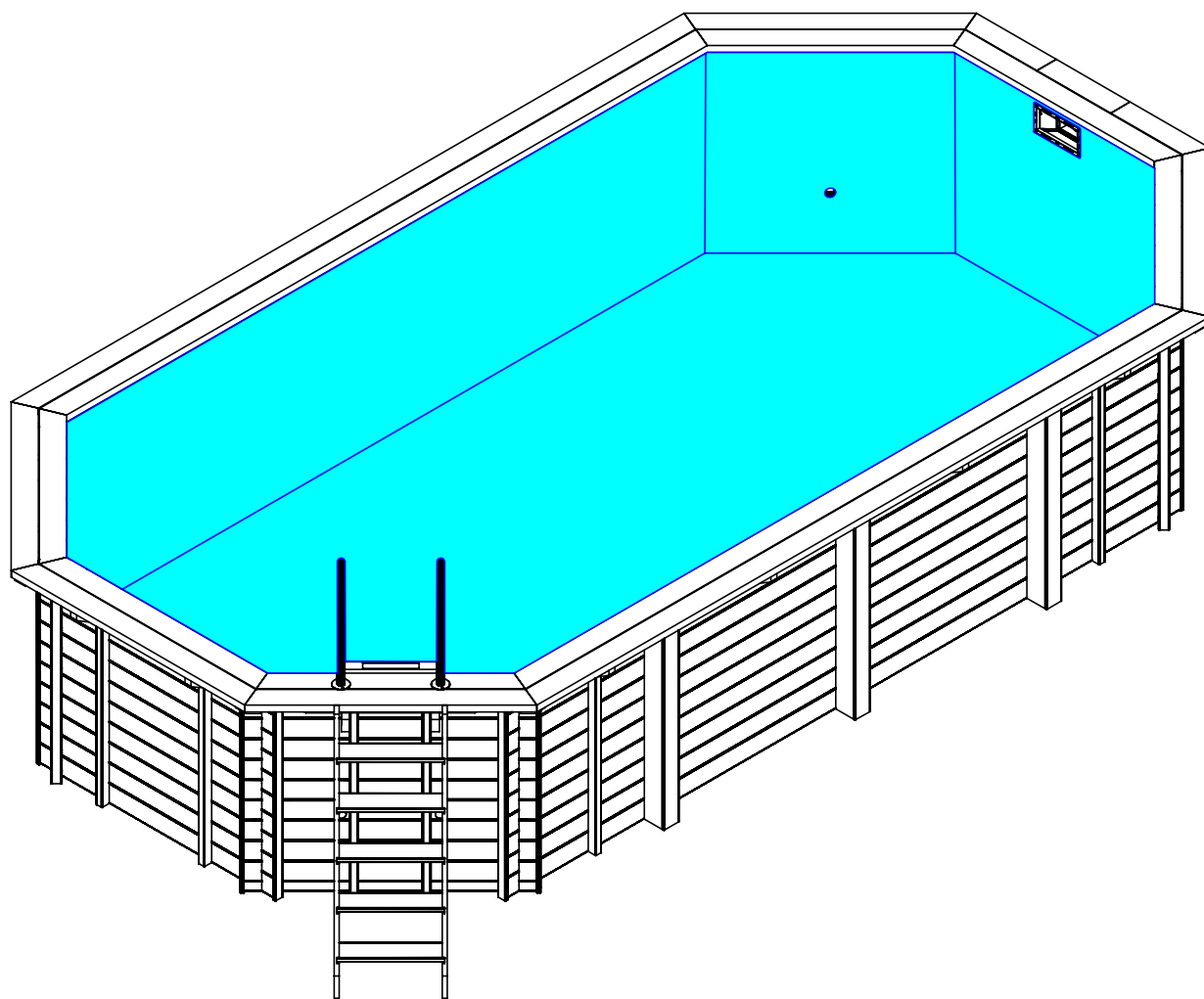

Wood warranty

5
years

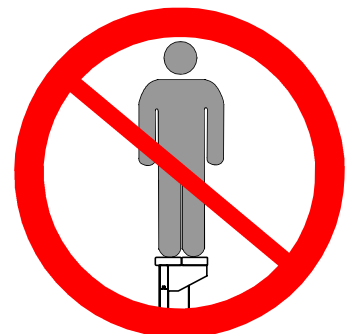
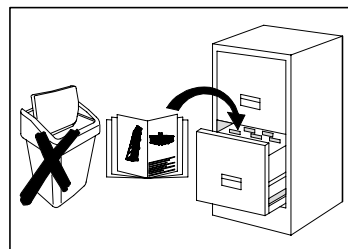
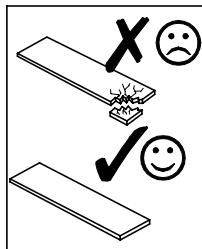
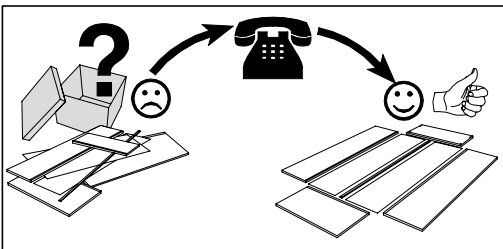
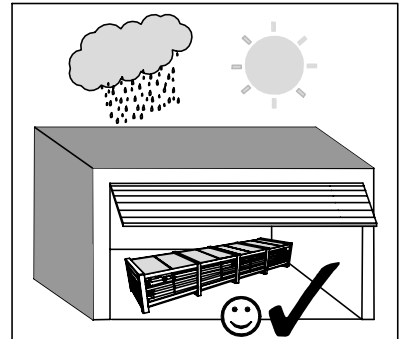
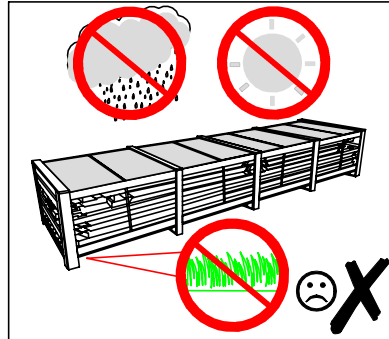
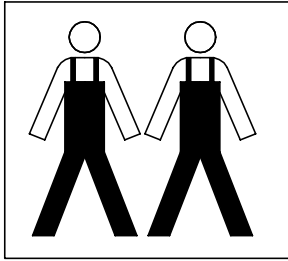
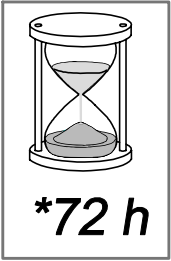

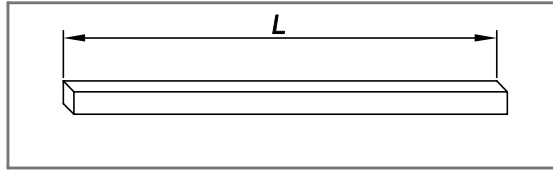

<p>L-5090 mm x18</p>	<p>L-5090 mm x2</p>
<p>L-1780 mm x1</p>	<p>L-1780 mm x1</p>
<p>L-1780 mm x1</p>	<p>L-1780 mm x17</p>
<p>L-1580 mm x34</p>	<p>L-1580 mm x2</p>
<p>L-1580 mm x4</p>	<p>L-1580 mm x4</p>
<p>L-5066 mm x2</p>	<p>L-4942 mm x2</p>
<p>L-1556 mm x4</p>	<p>L-1432 mm x4</p>
<p>L-1756 mm x1</p>	<p>L-1632 mm x2</p>

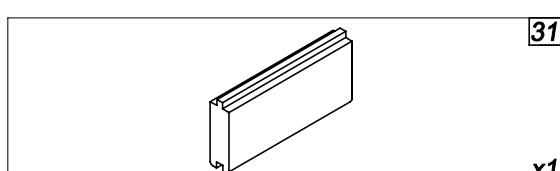
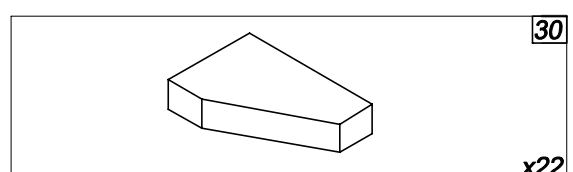
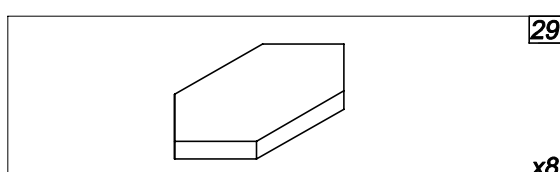
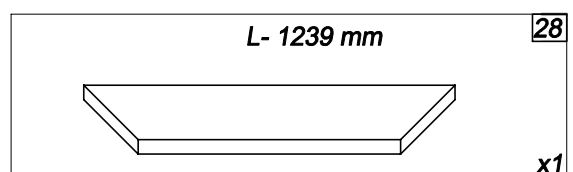
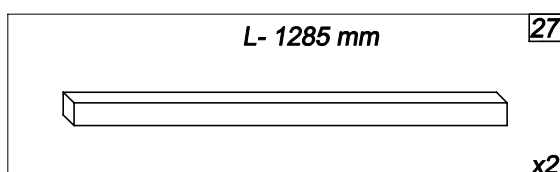
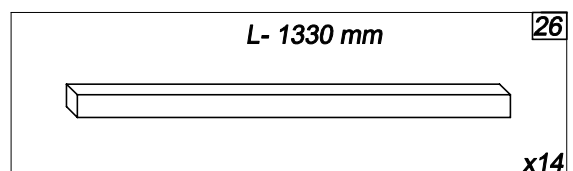
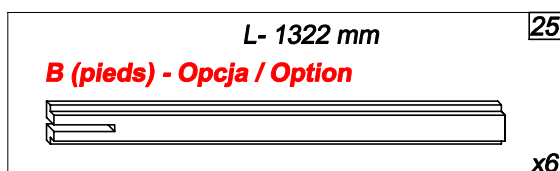
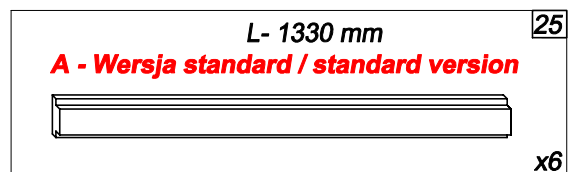
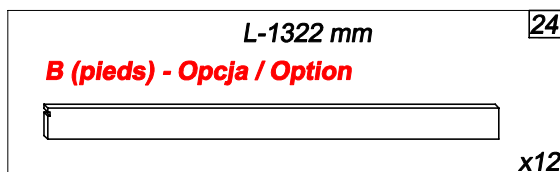
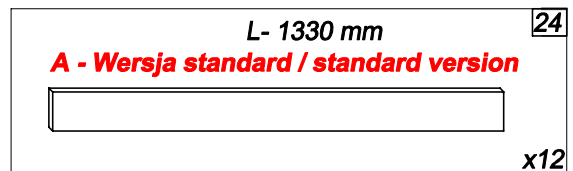
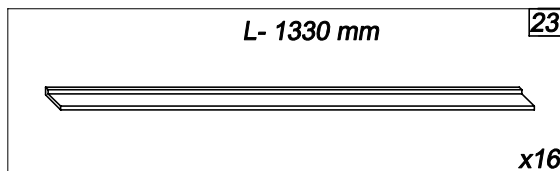
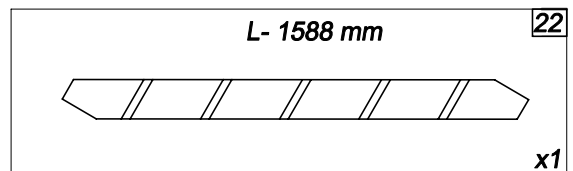
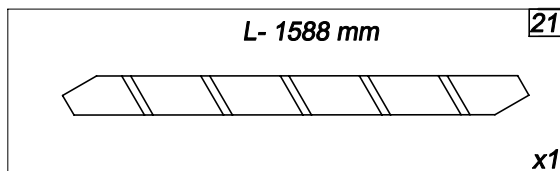
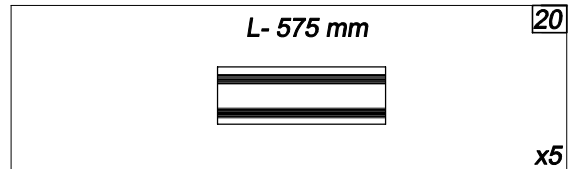
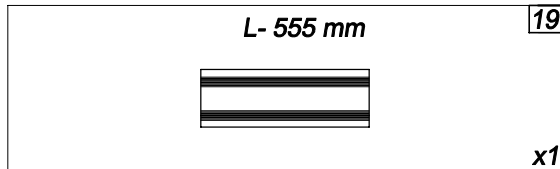
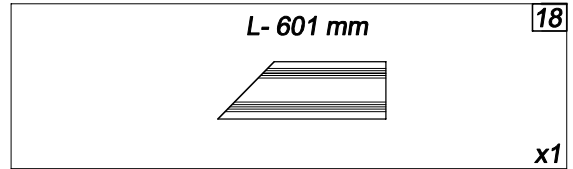
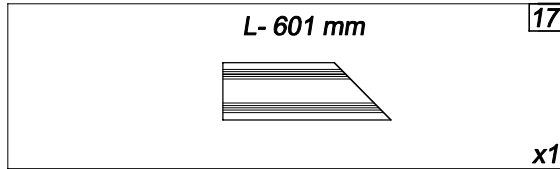

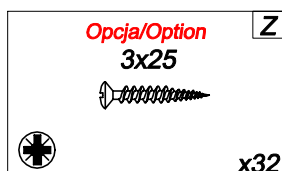
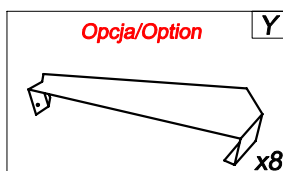
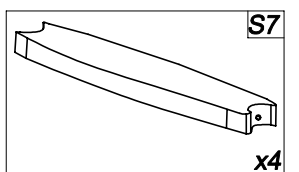
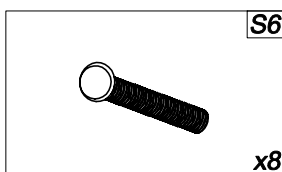
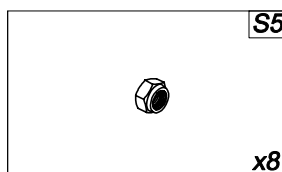
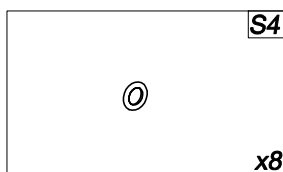
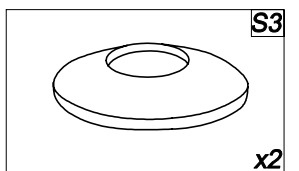
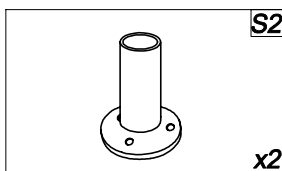
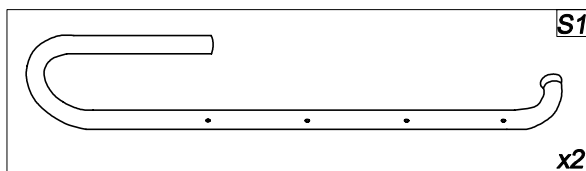
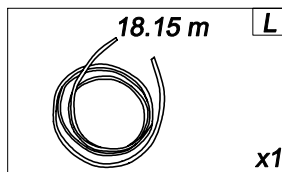
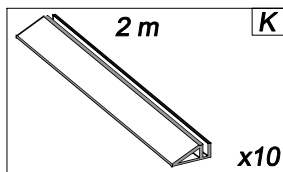
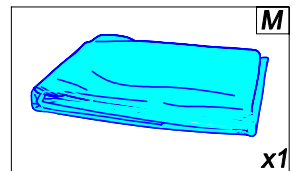
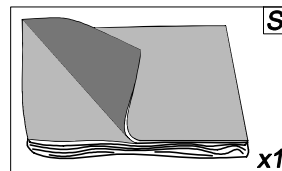
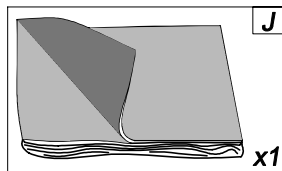
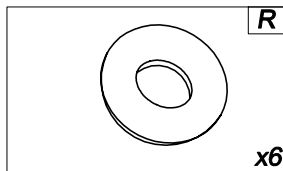
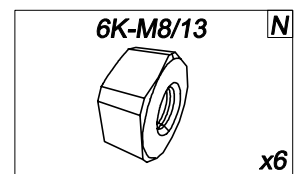
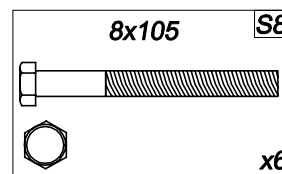
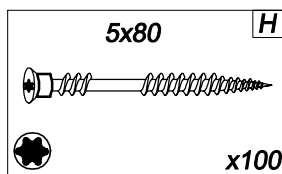
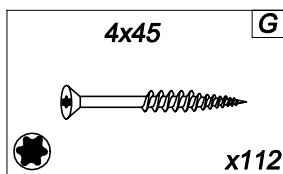
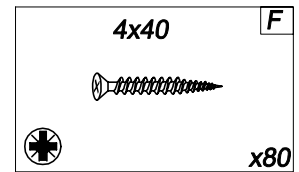
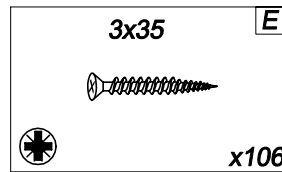
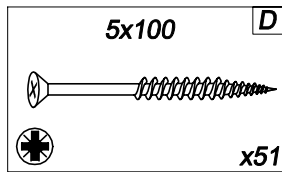
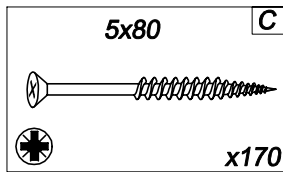
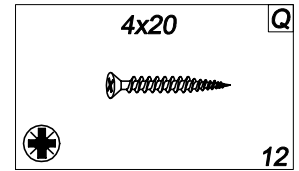
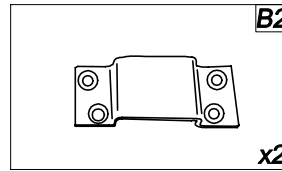
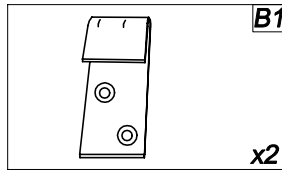
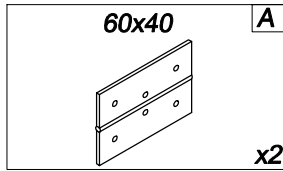



A - Wersja standardowa / Standard version

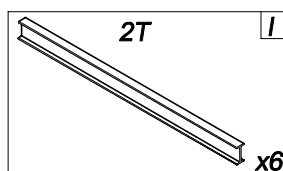

B (pieds) - opcja / option

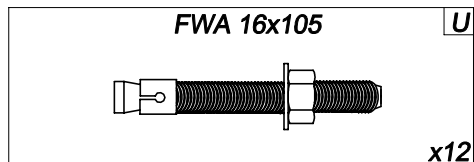
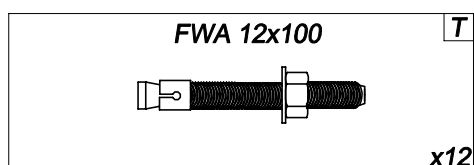
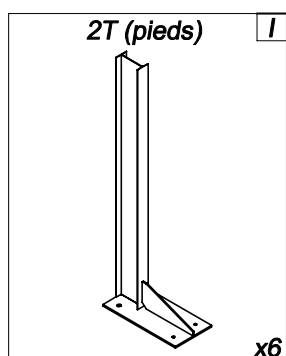

PL Elementy

GB Elements

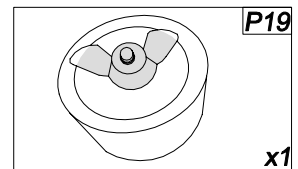
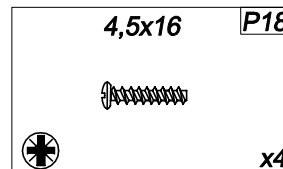
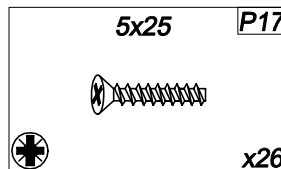
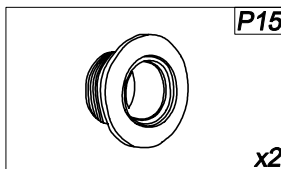
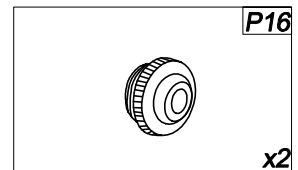
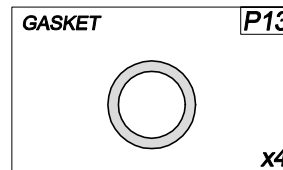
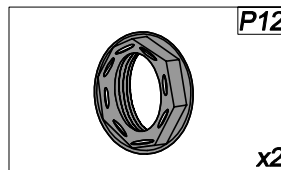
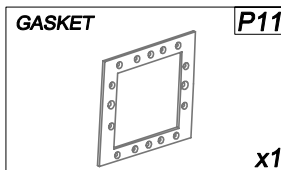
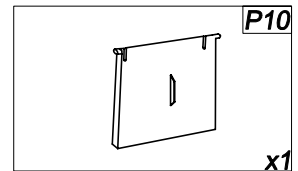
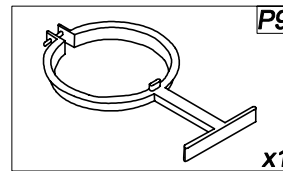
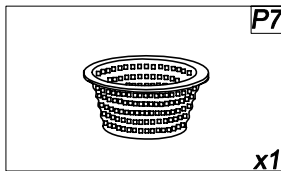
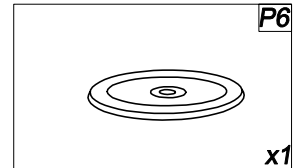
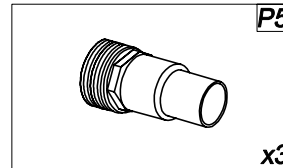
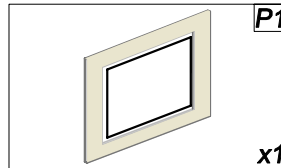
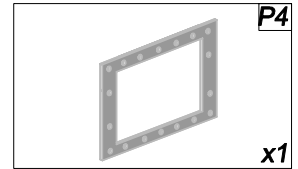
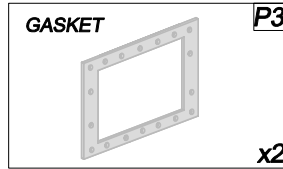
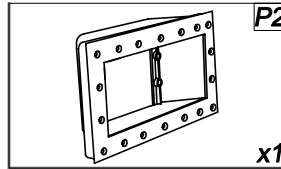
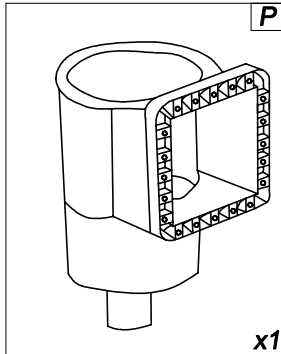

PL Widok po zmontowaniu.

GB After installation.

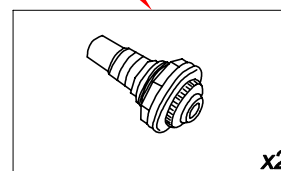
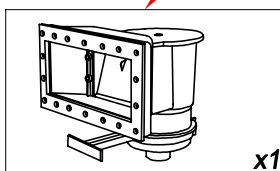

PL Zatyczka dyszy

GB Rubber plug



ZATYCZKA DO DYSZY - w celu przygotowania basenu do sezonu zimowego (w szczególności przy ryzyku zamarznięcia wody) zastosuj zatyczkę do dysz napływowych, odcinając dopływ wody do zestawu filtracyjnego. **Pozostaw dyszę w basenie, zamontuj zatyczkę.** Należy pamiętać również o odłączeniu zestawu filtracyjnego od źródła wody i dokładnym osuszeniu dysz od strony zewnętrznej. Zaleca się także, aby z pompy jak i dołączonego filtra piaskowego na okres zimy (w miejscach gdzie występują mrozy) usunąć pozostałości wody, w innym przypadku zamarzająca woda może dokonać zniszczenia całości zestawu.

Rubber plug - in order to prepare the pool for the winter season (especially if there is a risk of freezing) put a plug into the inlet to shut off the access of water to the filtration system. **Inlet must remain in the pool.**

Fix the plug under water. Remember to disconnect the filtration set from the pool and dry the inlet (the part of inlet which is outside of the pool). For the winter season, it is recommended to get rid of water remaining in pump and sand filter, otherwise freezing water can cause devastation of the whole set.

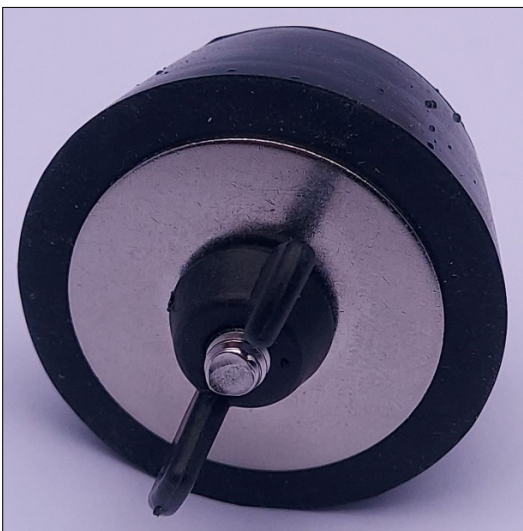
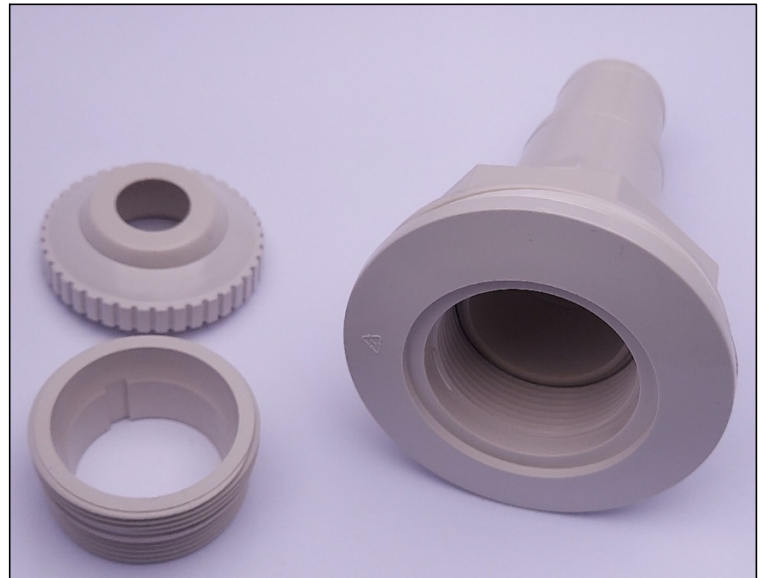

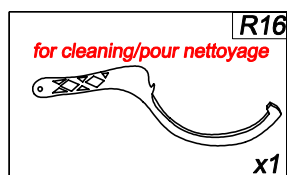
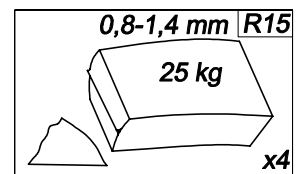
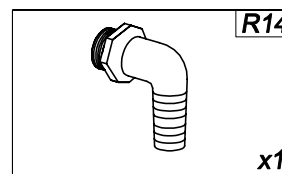
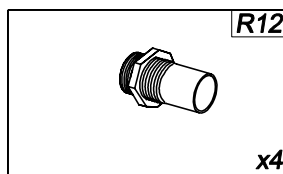
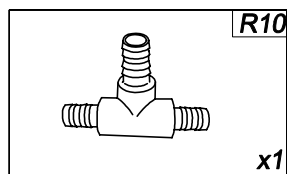
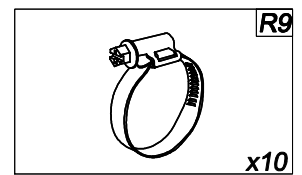
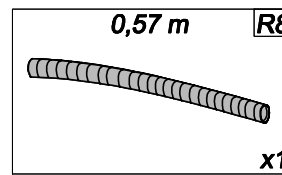
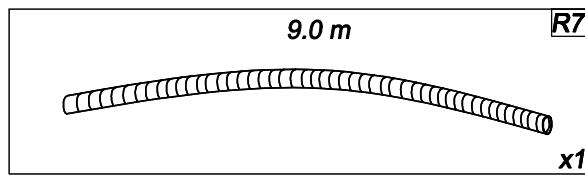
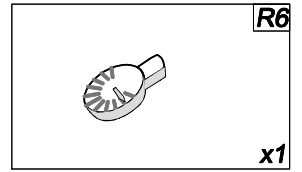
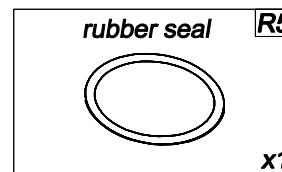
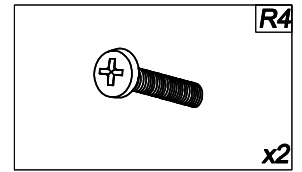
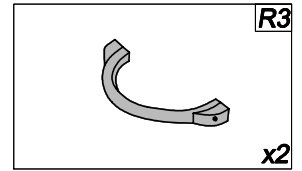
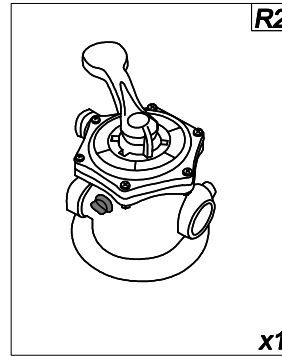
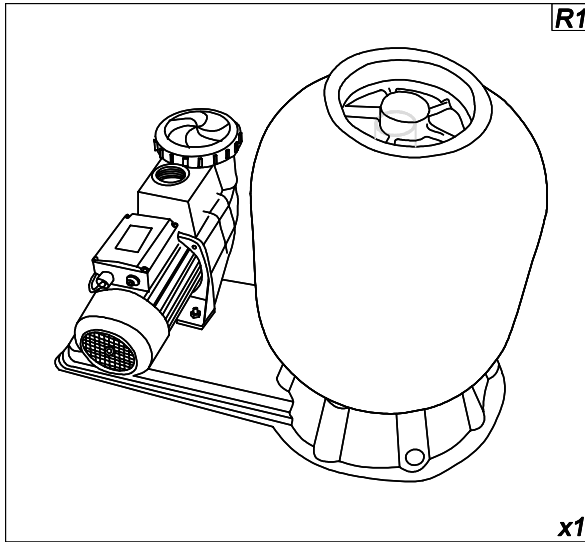

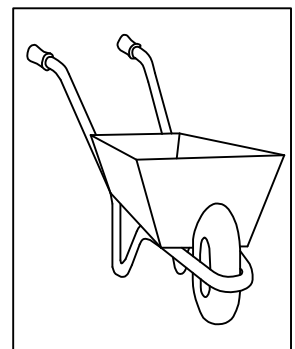
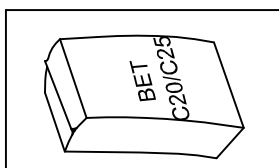
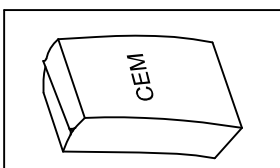
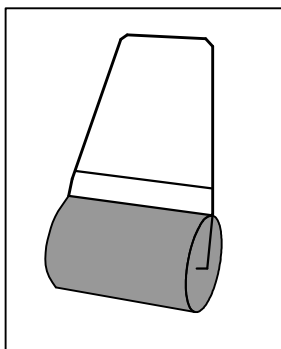
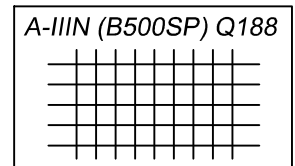
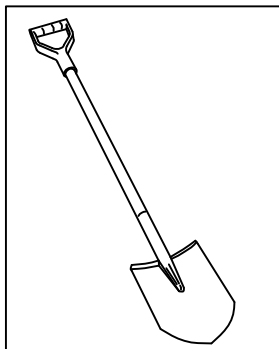
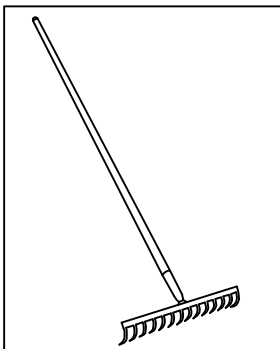
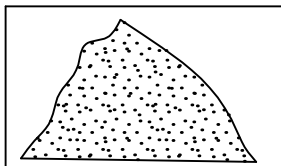
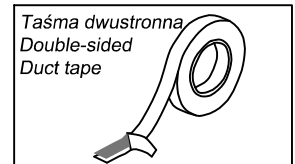
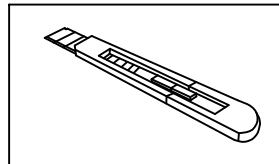
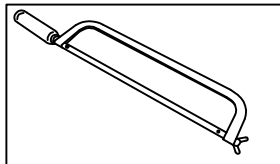
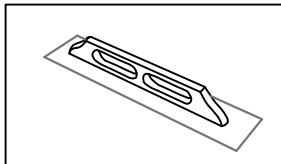
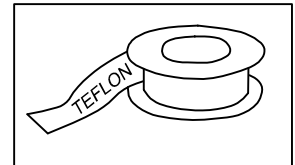
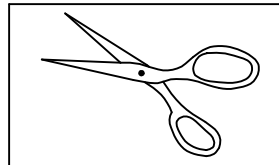
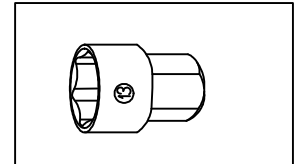
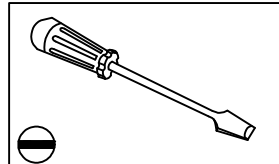
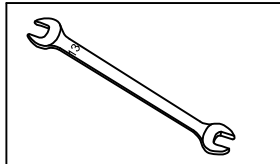
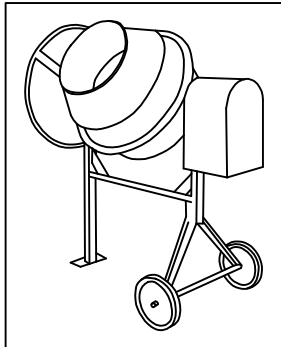
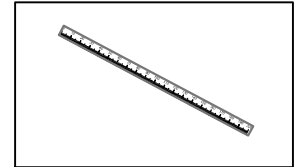
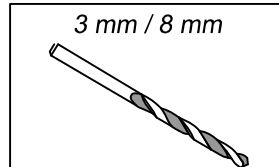
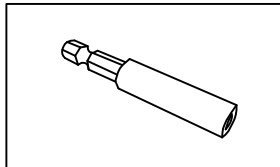
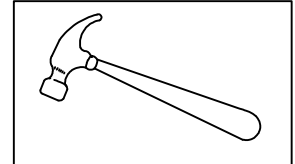
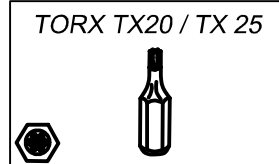
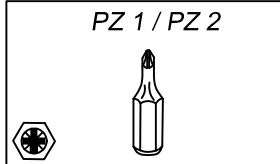
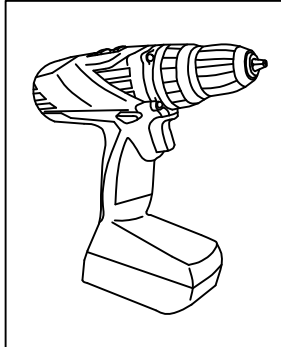
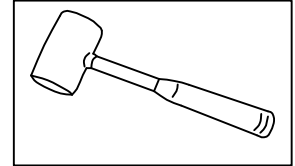
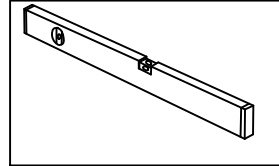
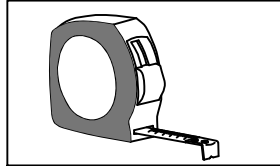
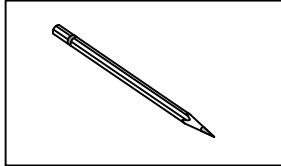

PL Podłoże

GB Ground

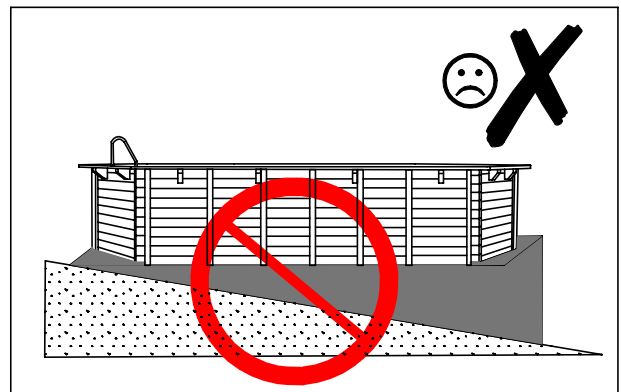
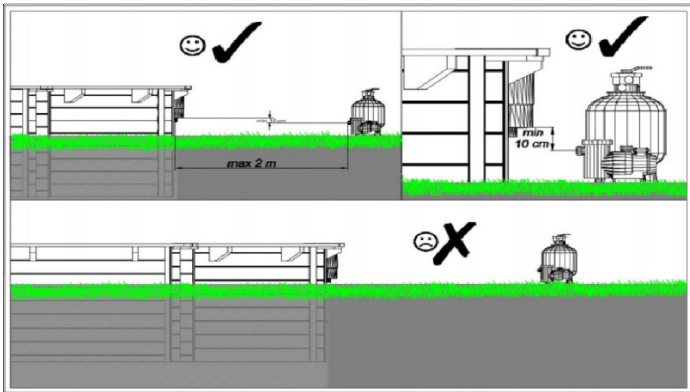
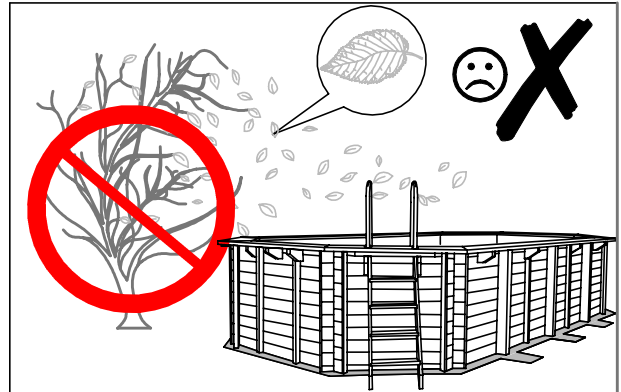
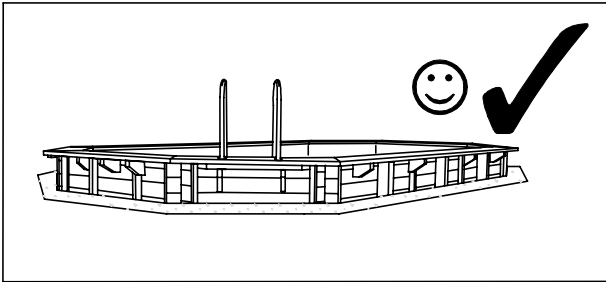
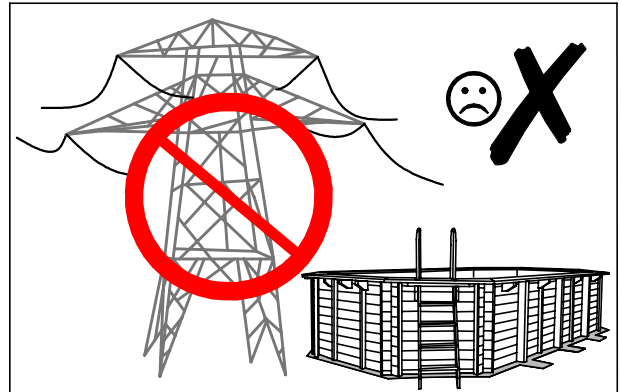
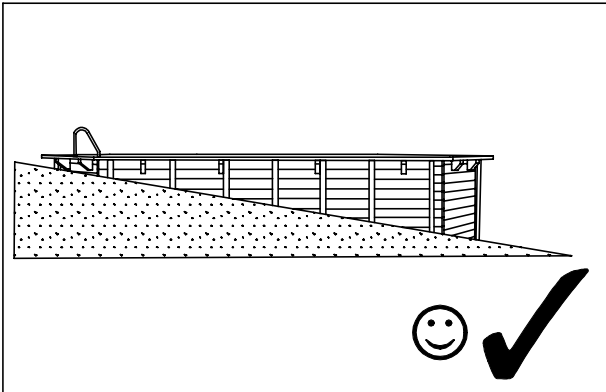
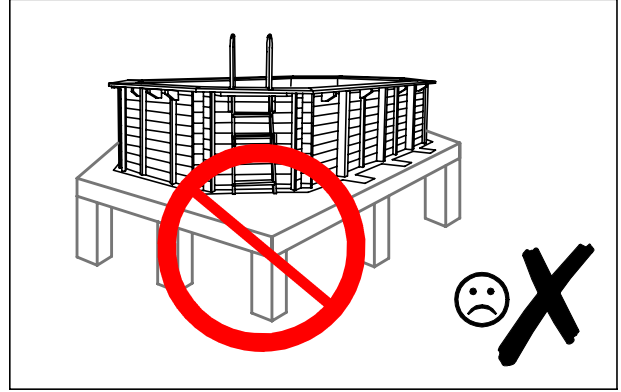
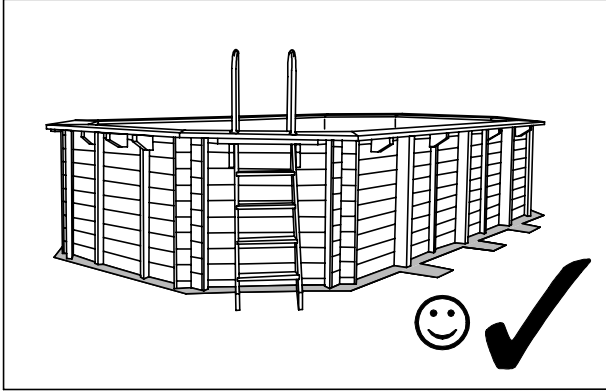



- 1 FUNDAMENT BASENU / FUNDATION
- 2 RURA DRENARSKA / DRAINAGE PIPE
- 3 PEŁCZERZYKOWA FOLIA FUNDAMENTOWA / FOUNDATION BUBBLE WRAP
- 4 ŻWIR / GRAVEL
- 5 GEOWŁÓKNINA OGRODOWA / GEOTEXTILE
- 6 GRUNT / GROUND

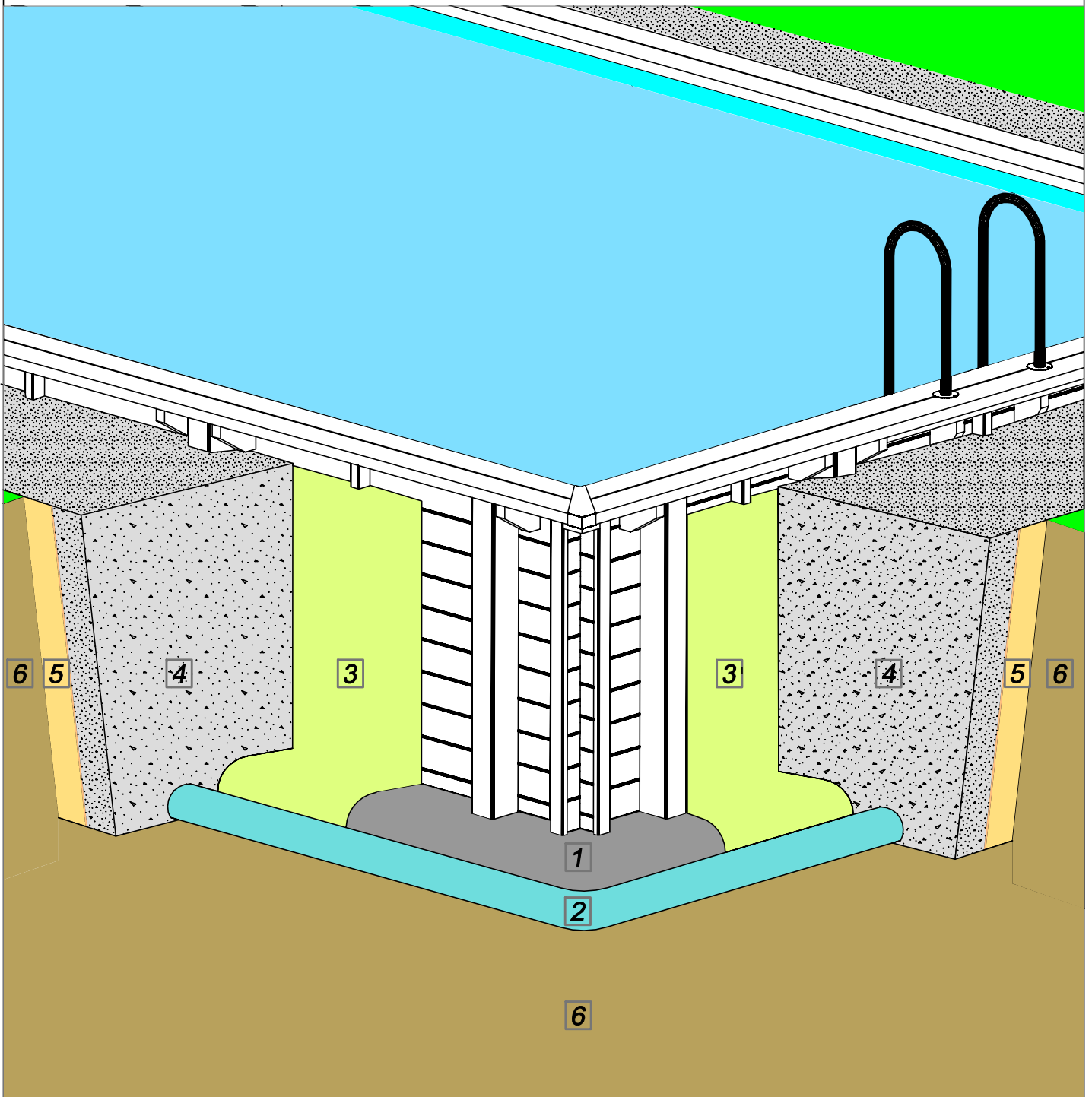

PL Podłoże

GB Ground



[mm]

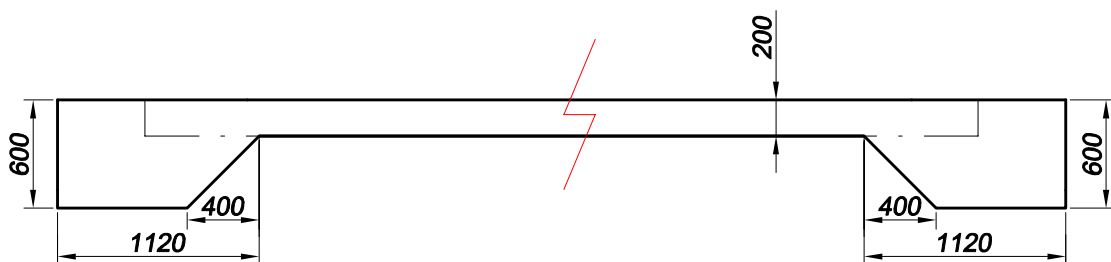
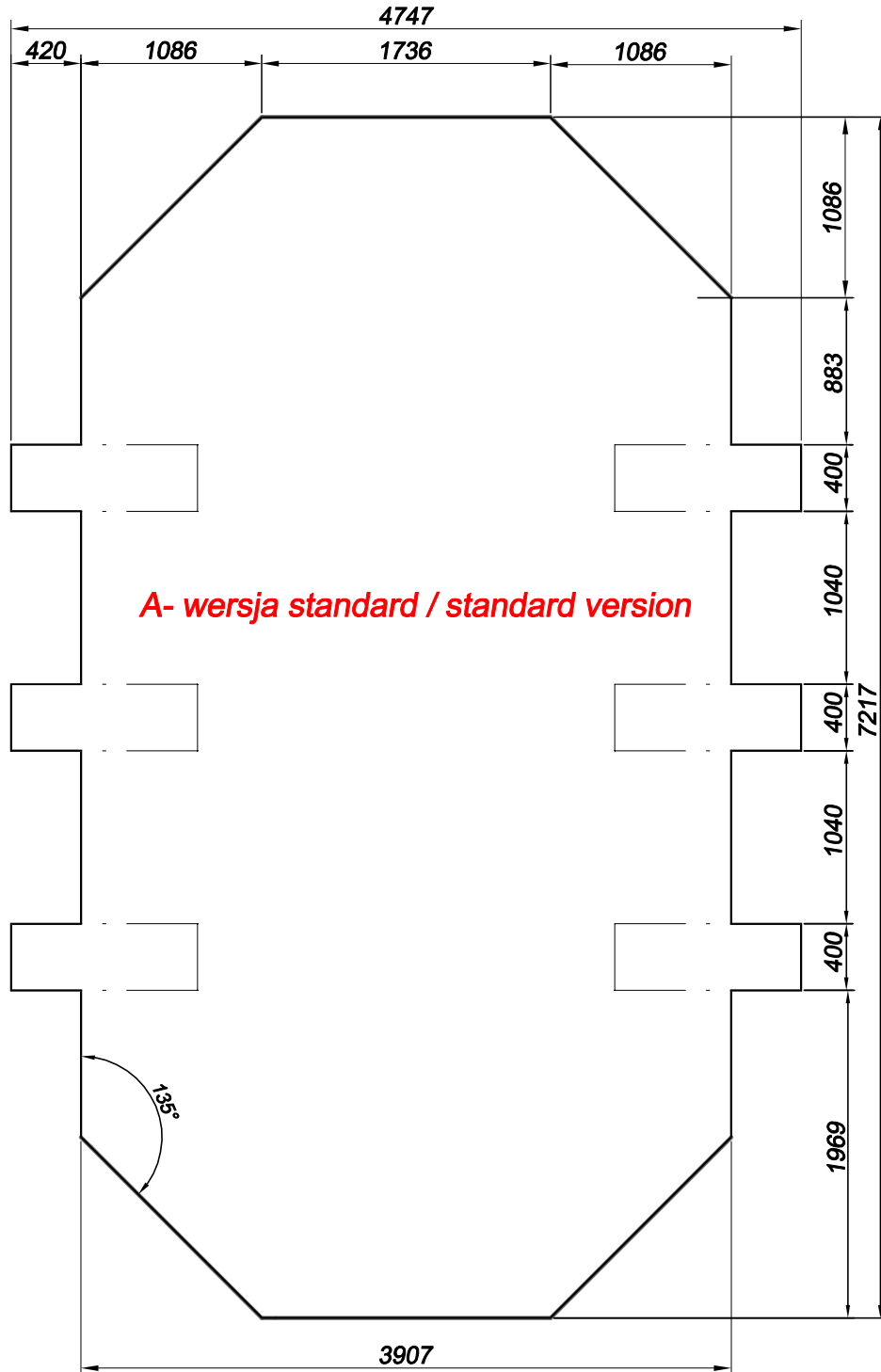

PL Podłoże

GB Ground

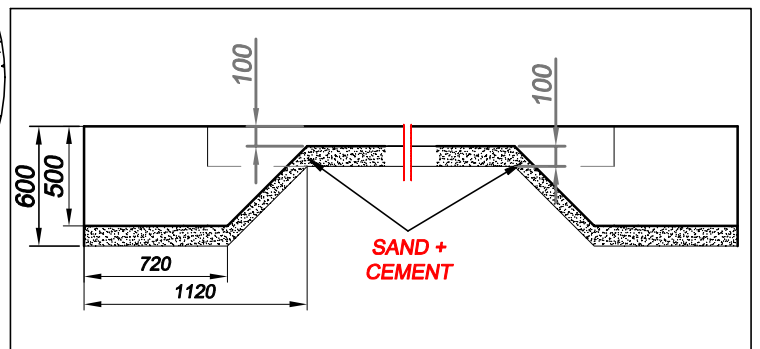
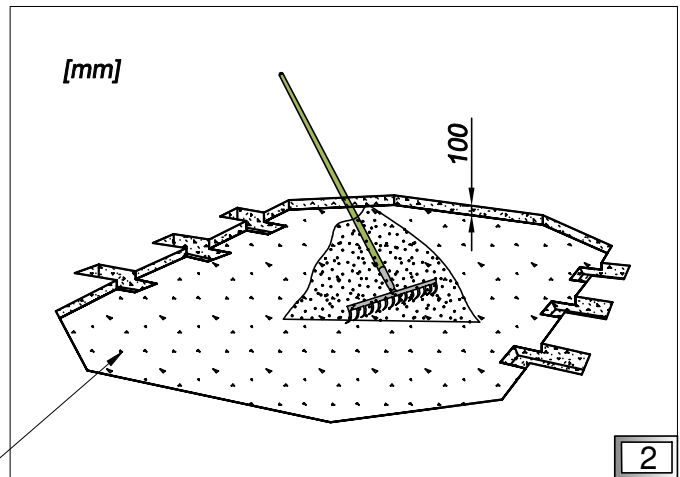
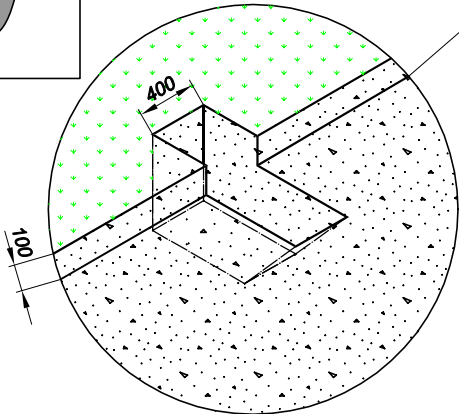
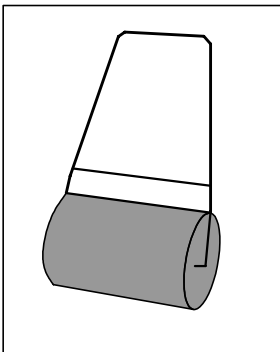
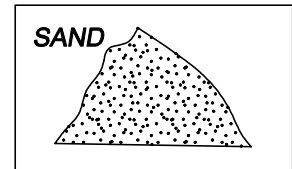
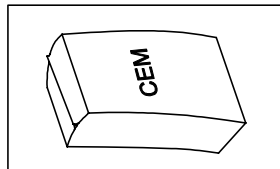
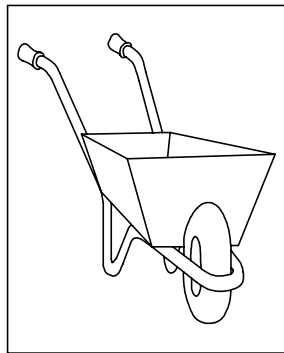
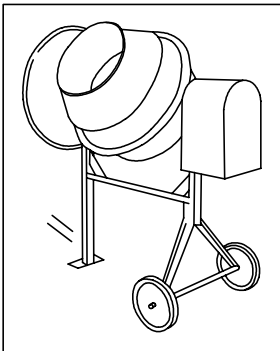
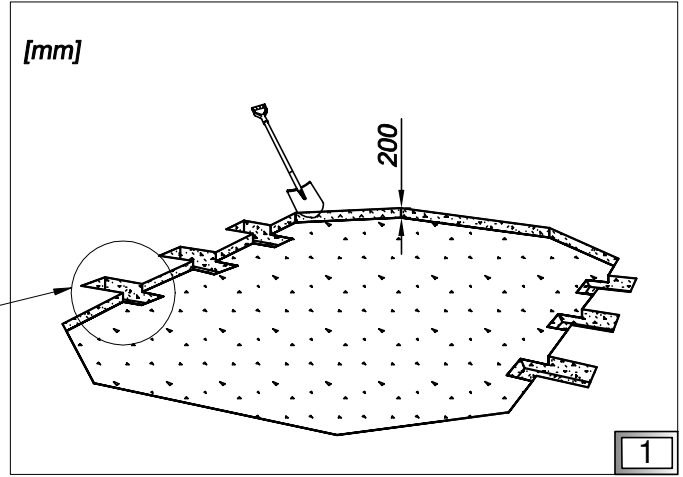
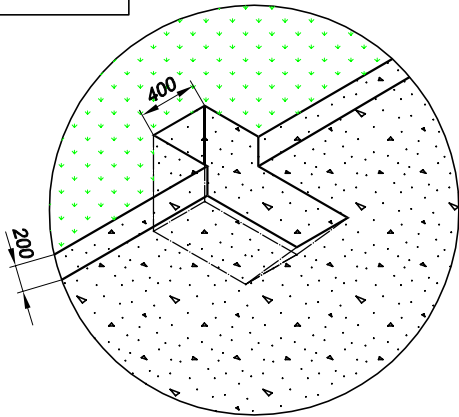
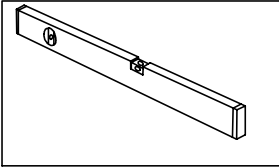

PL Podłoże

GB Ground



A- wersja standard / standard version

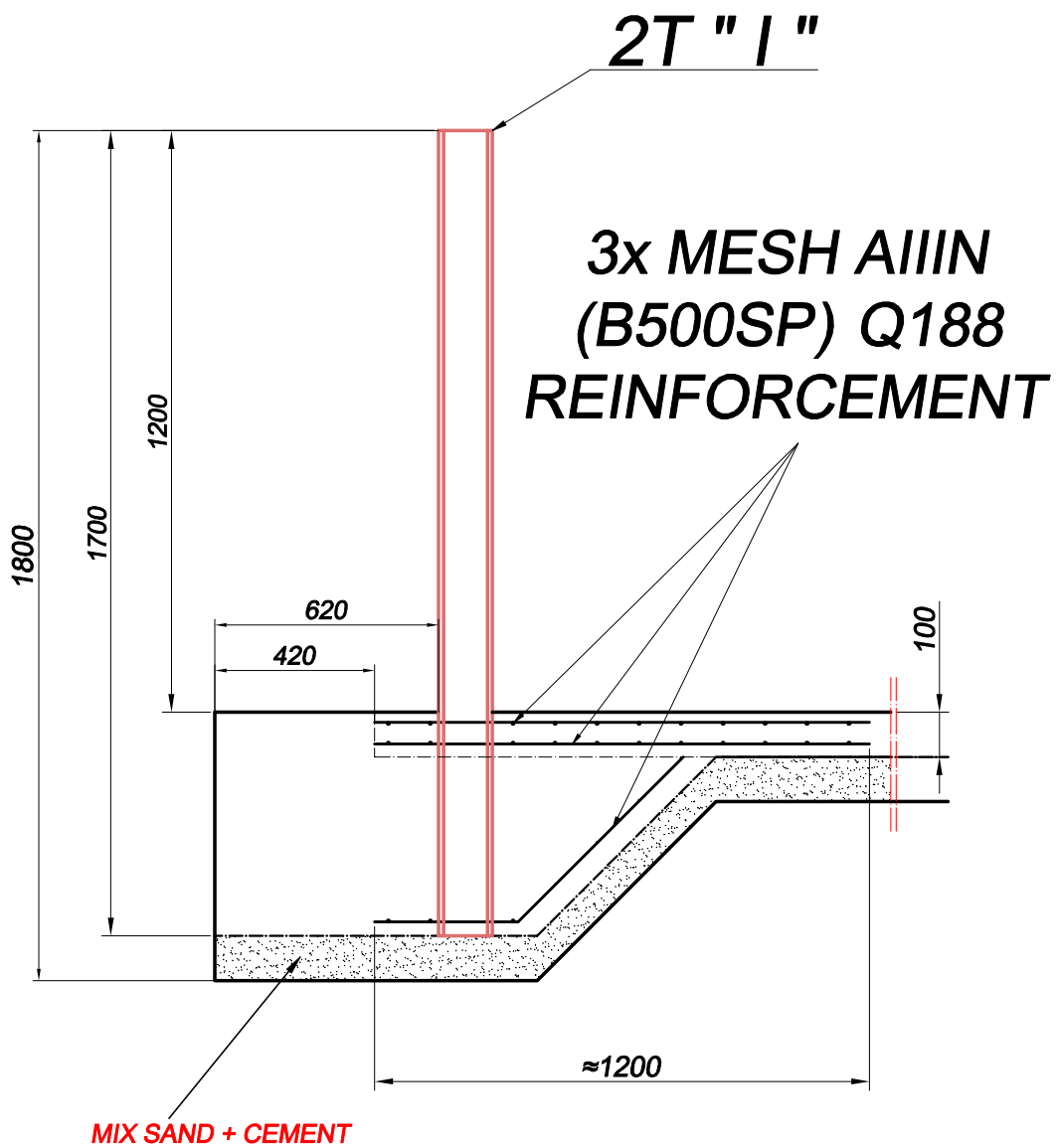

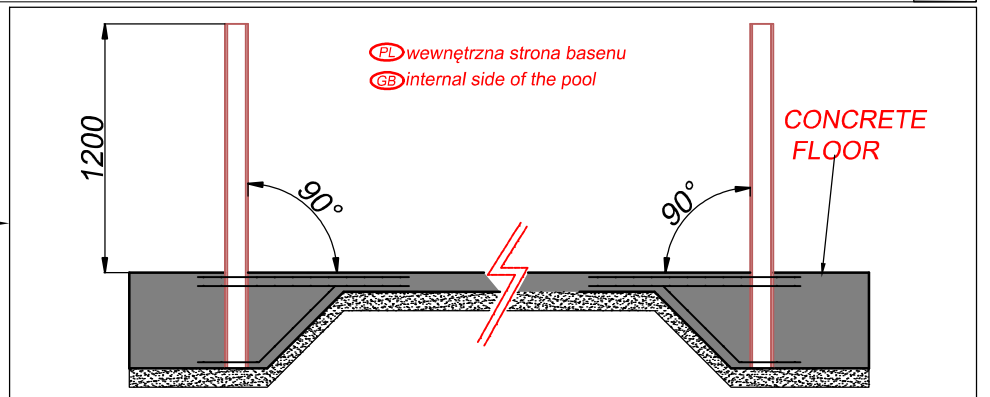
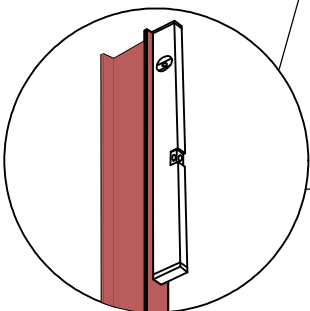
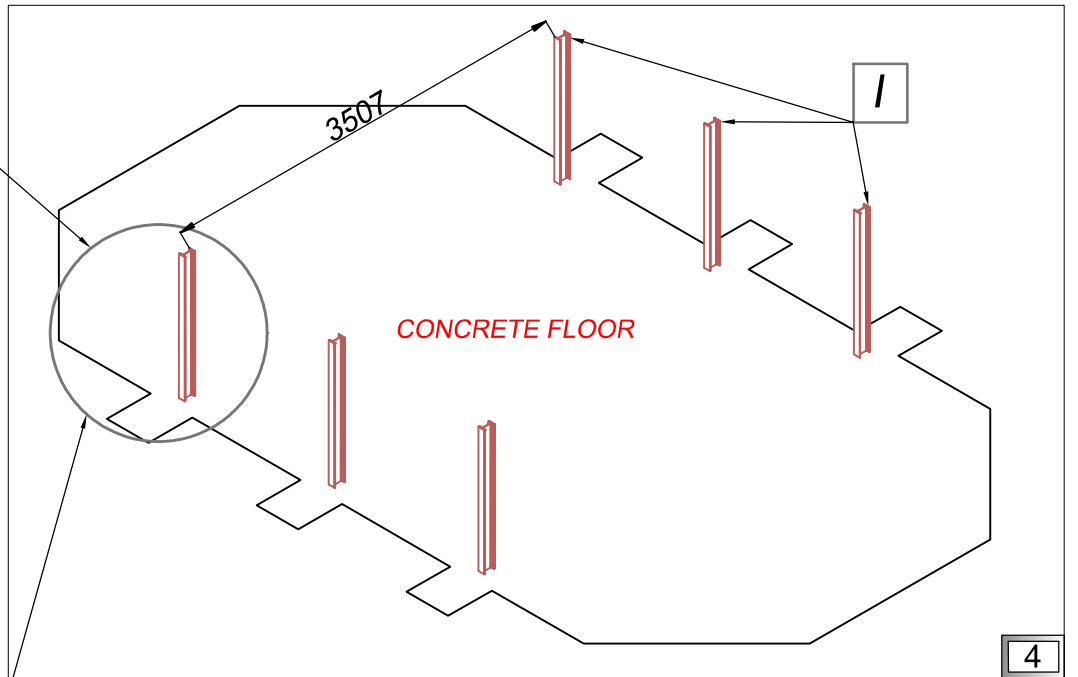
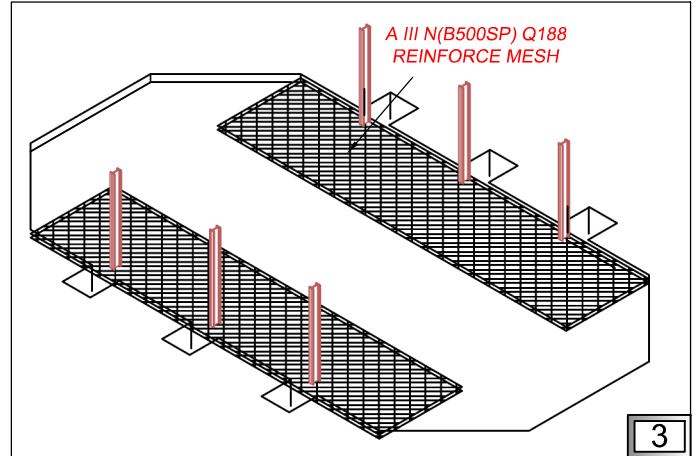
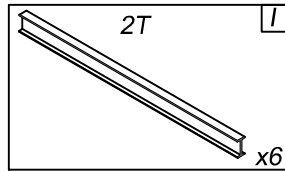
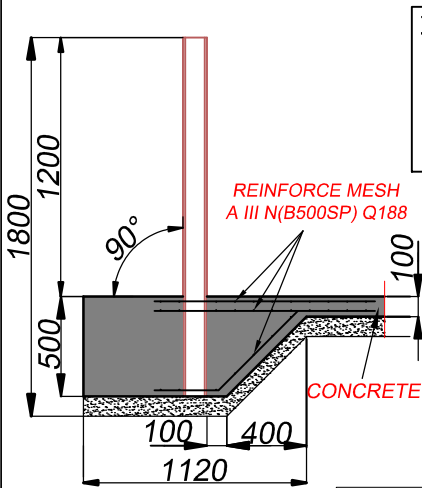
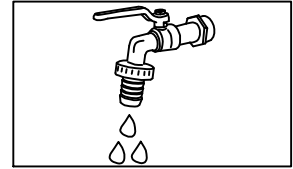
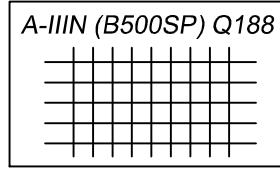
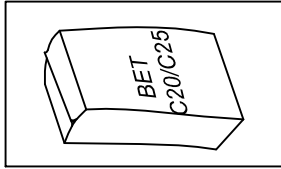

PL Podłóże

GB Ground

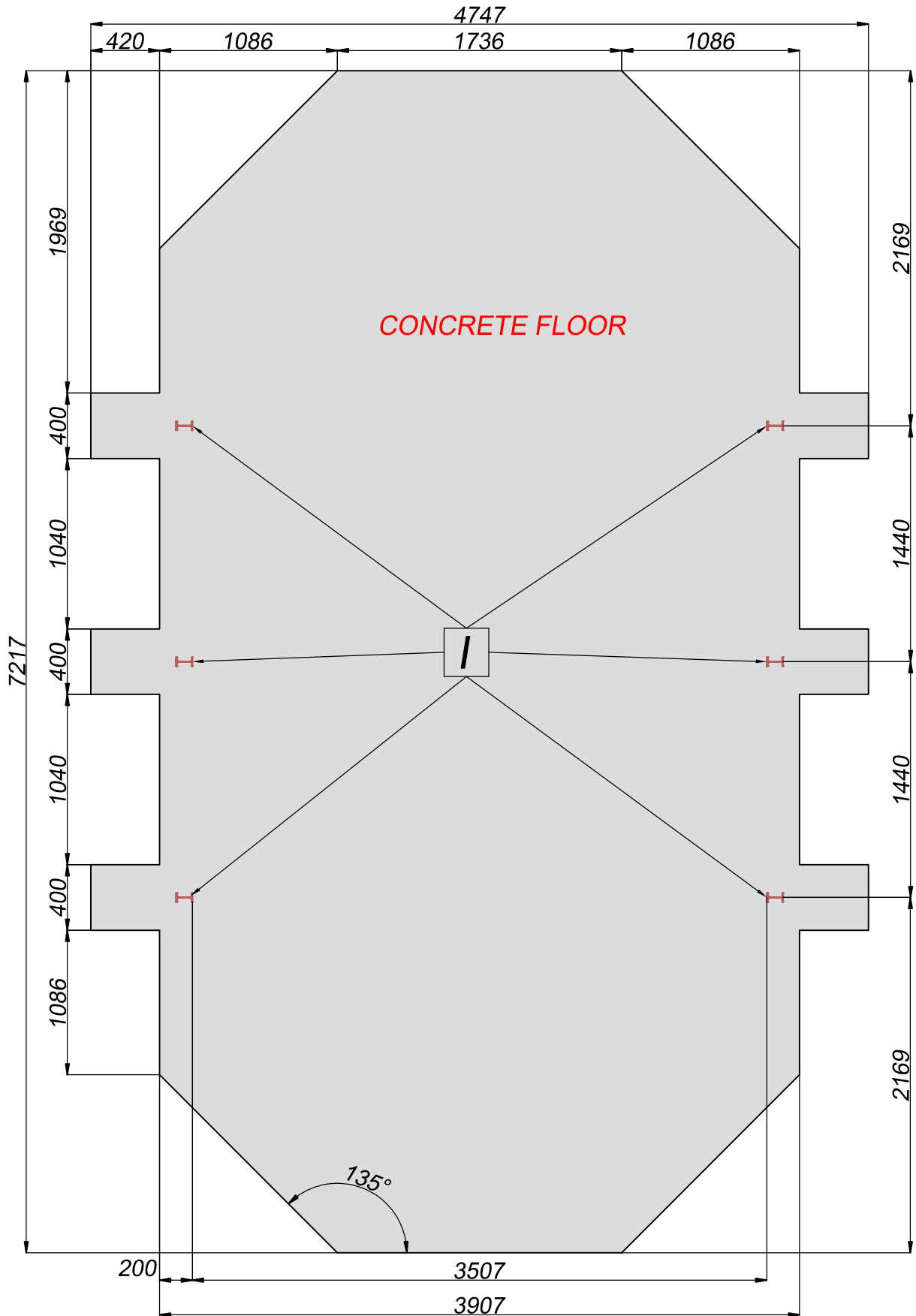

PL Podłoże

GB Ground



B (pieds) - opcja / option

4707

8017

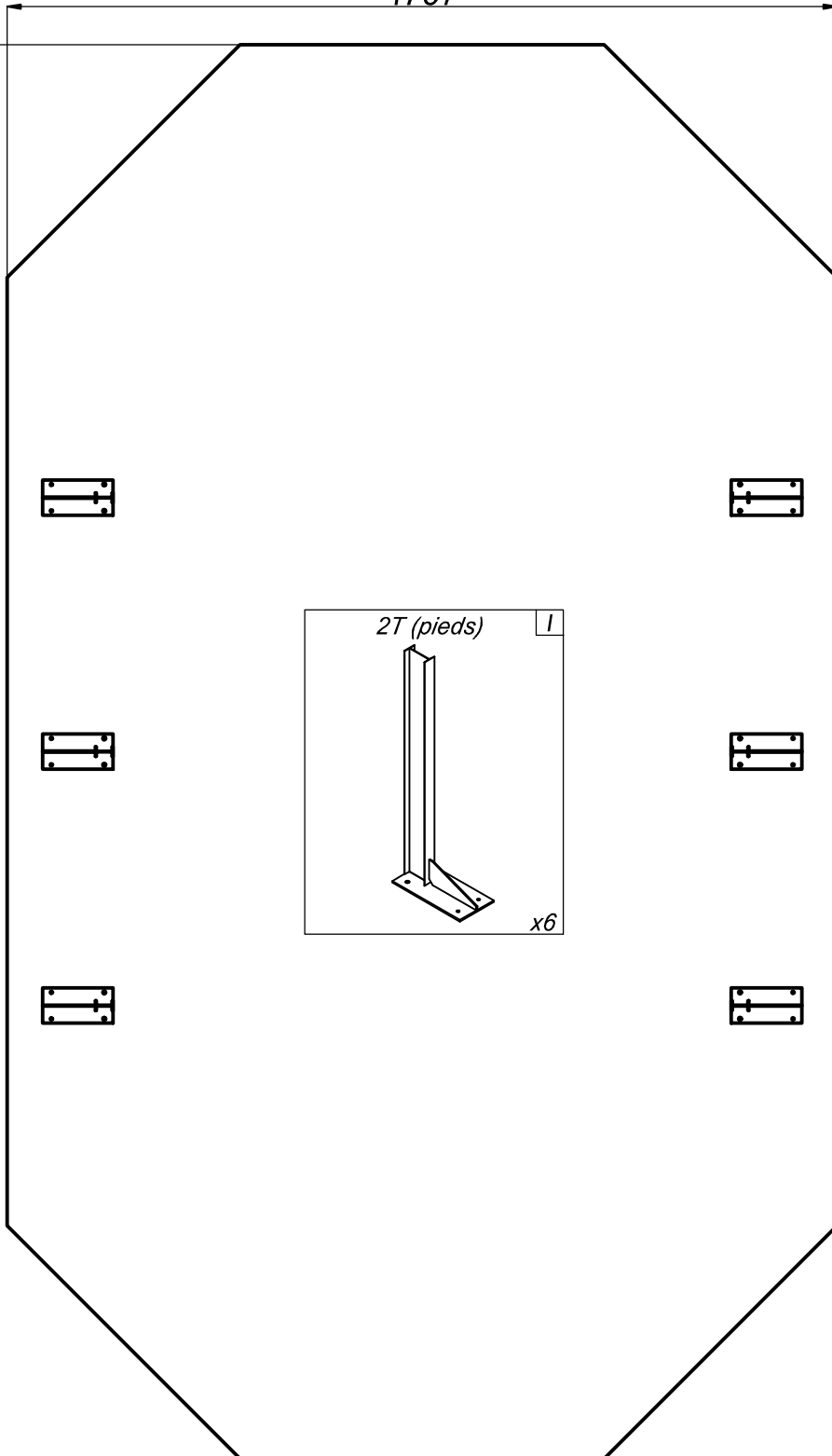

2T (pieds)

1

x6



B (pieds) - opcja / option

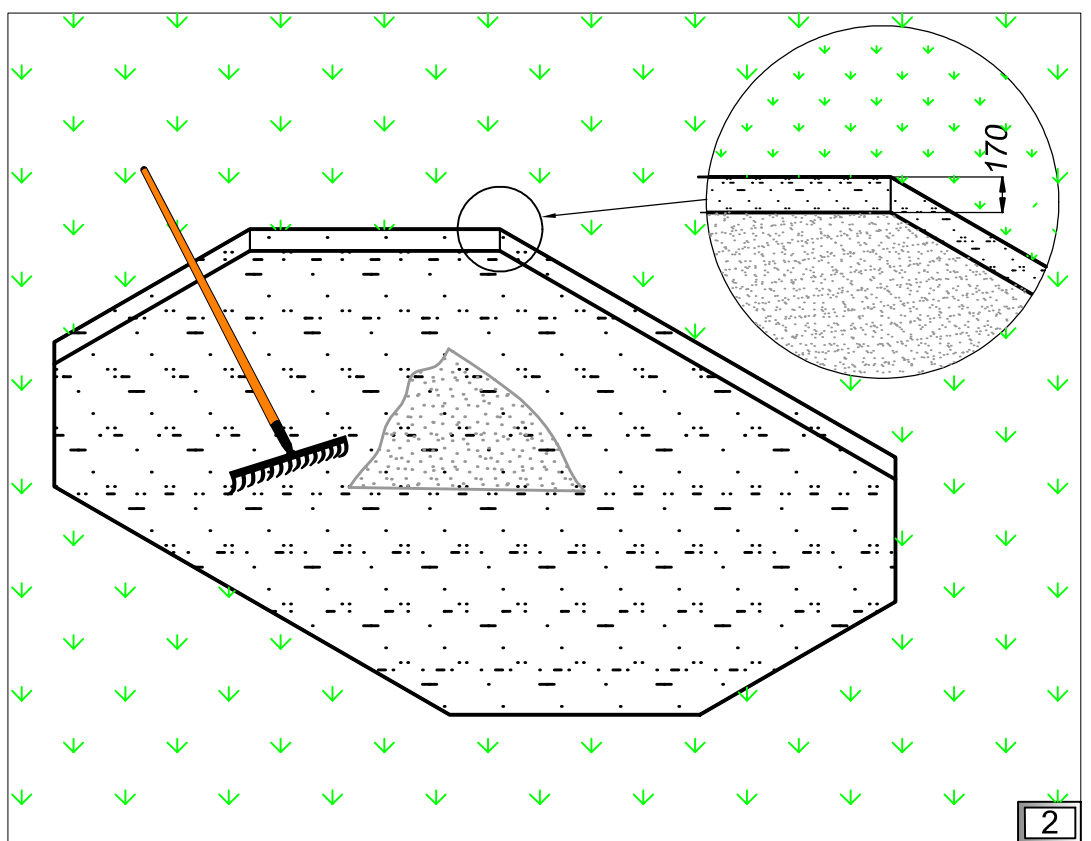
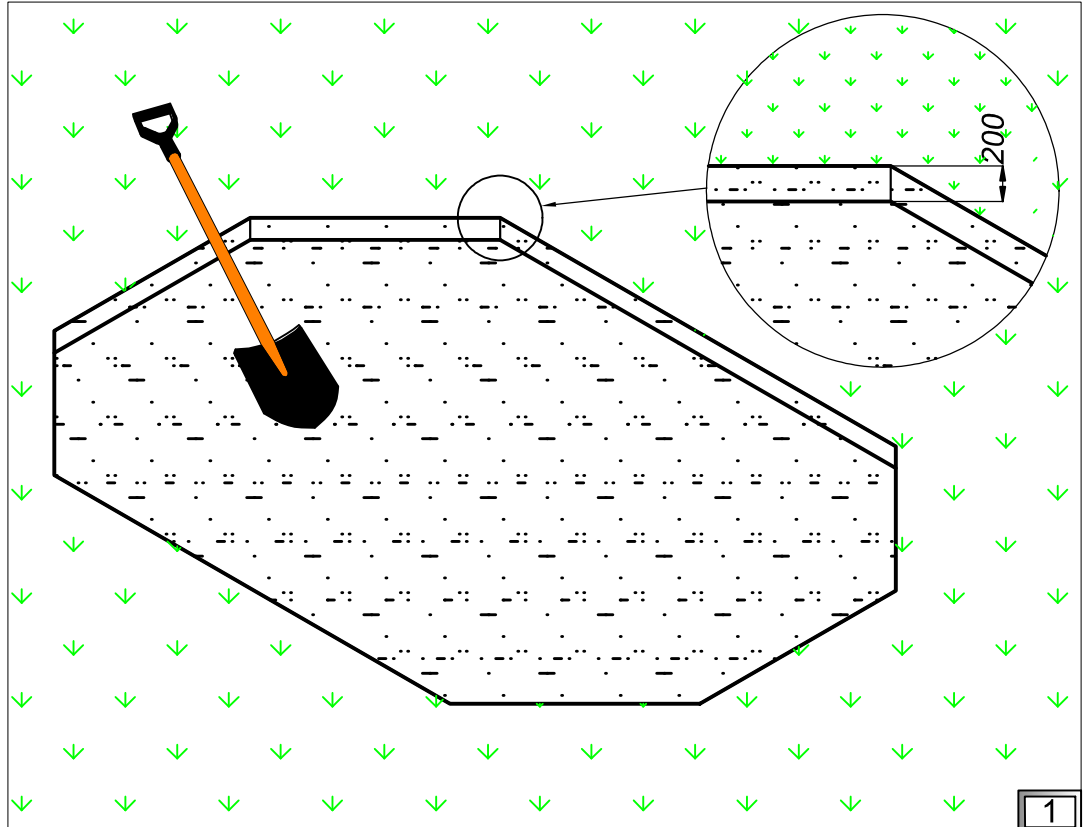
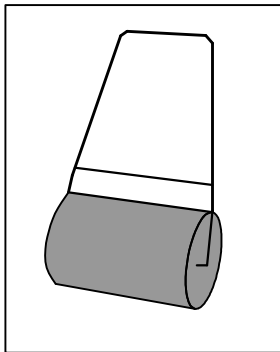
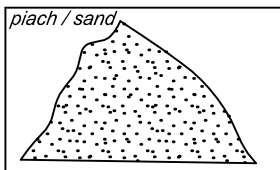
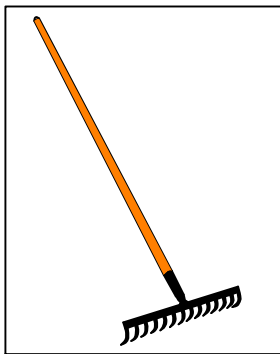
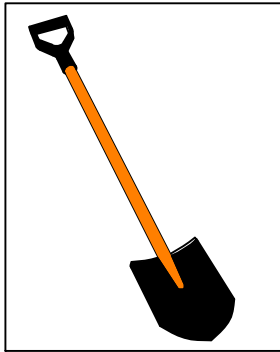

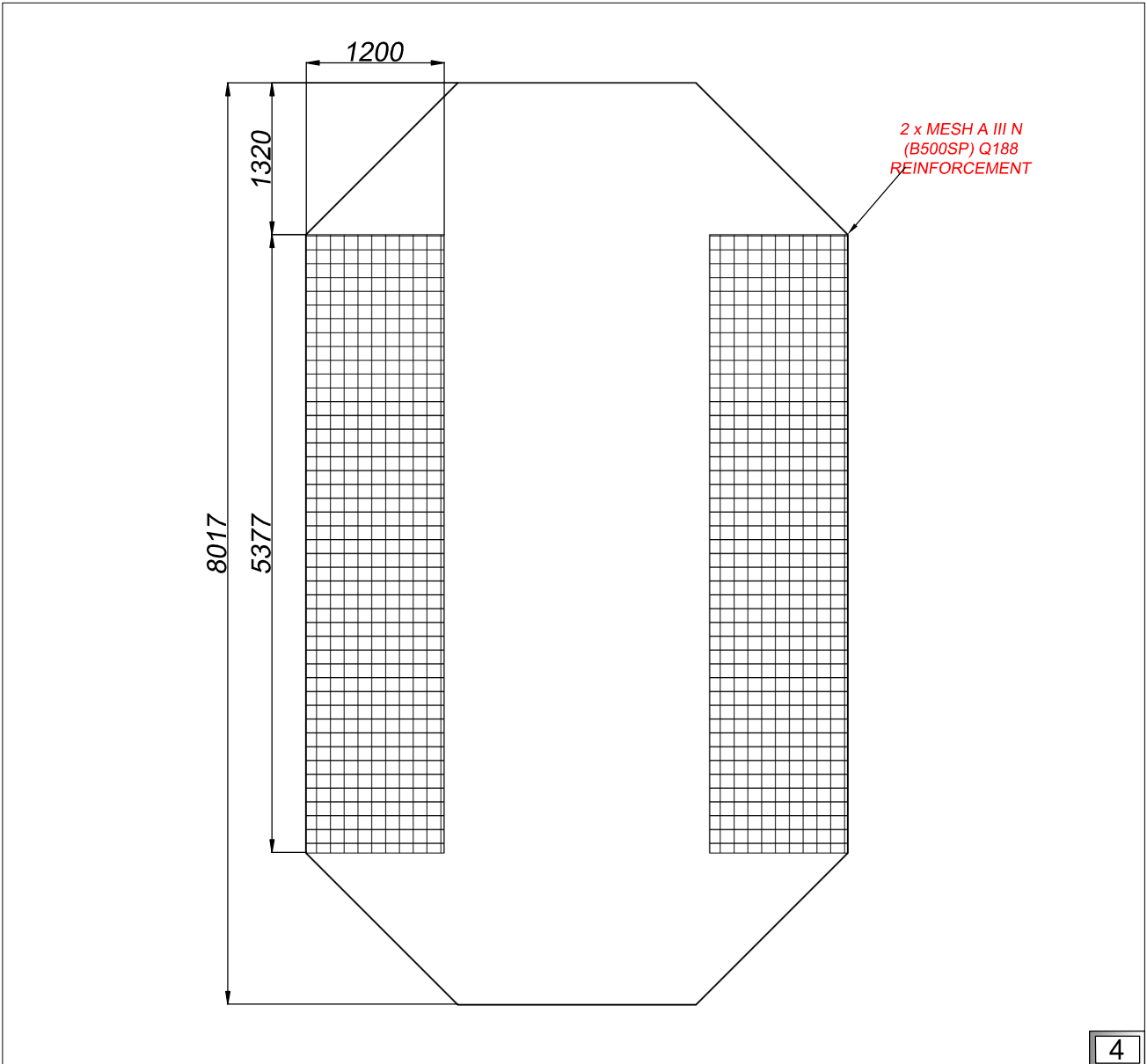
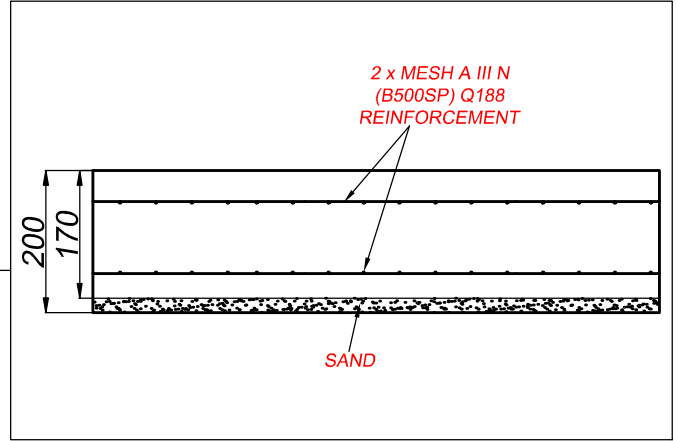
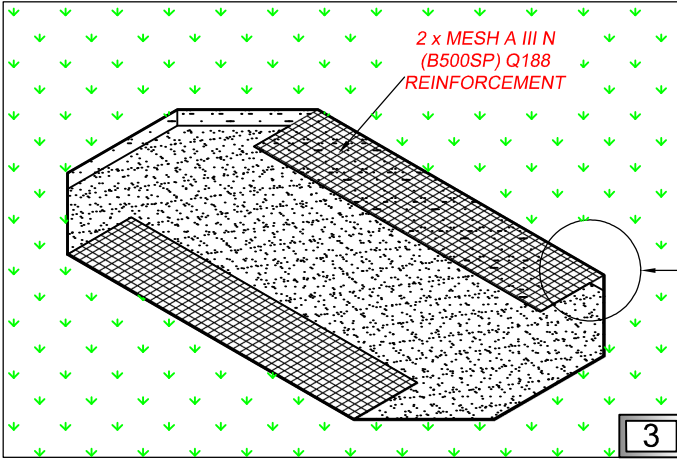



B (pieds) - opcja / option

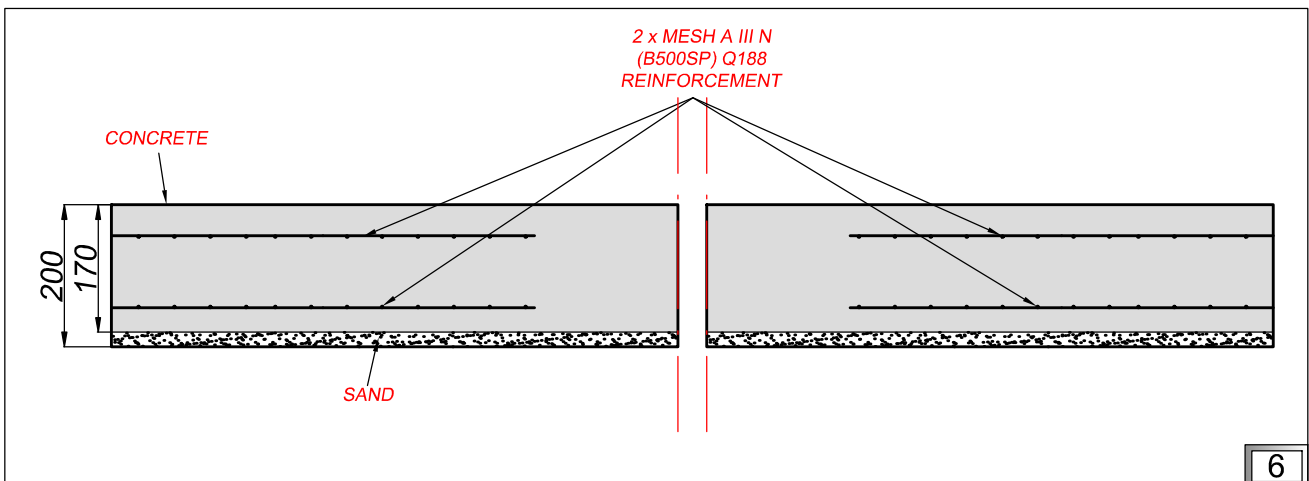
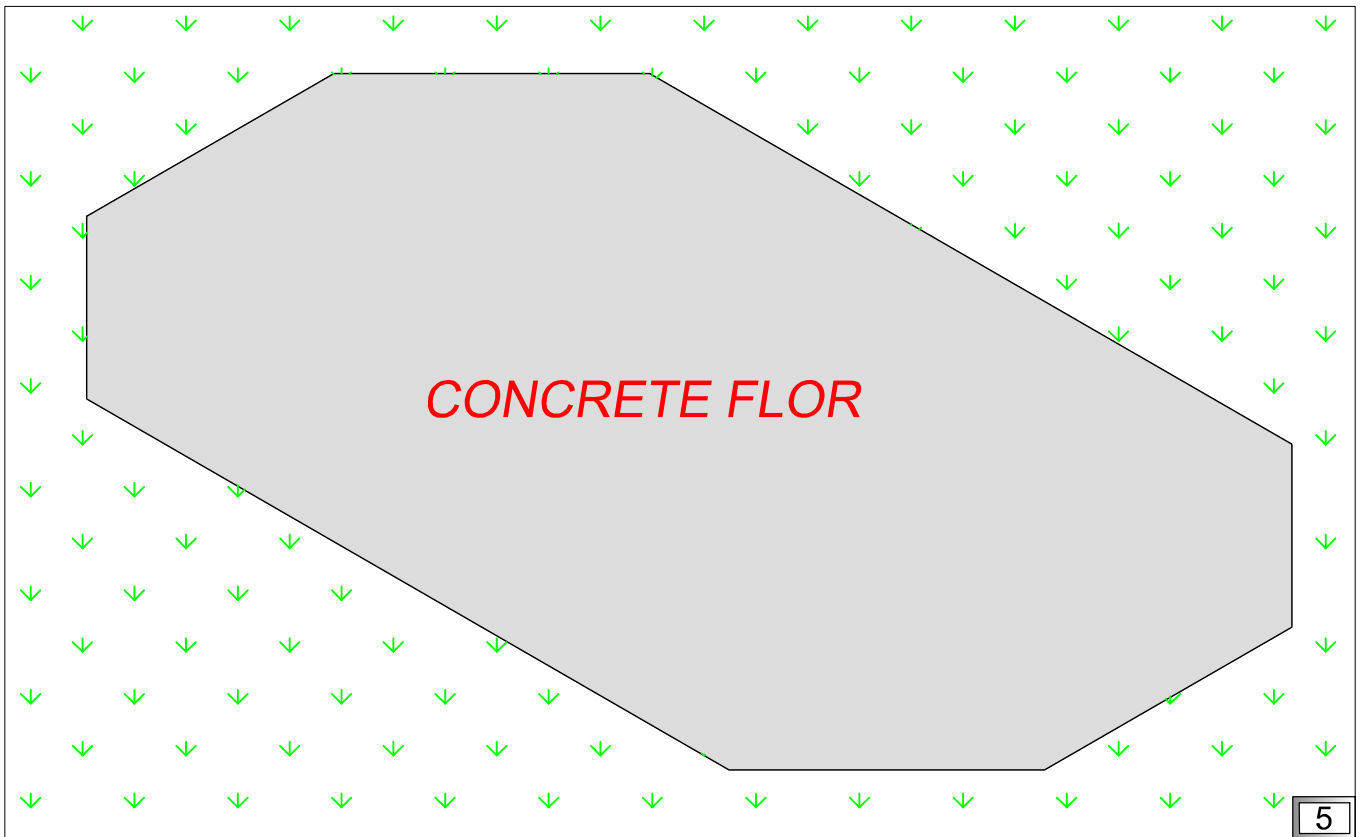
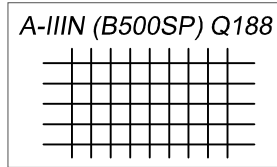
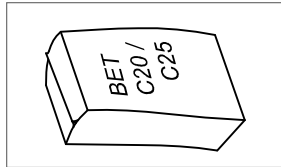



B (pieds) - opcja / option

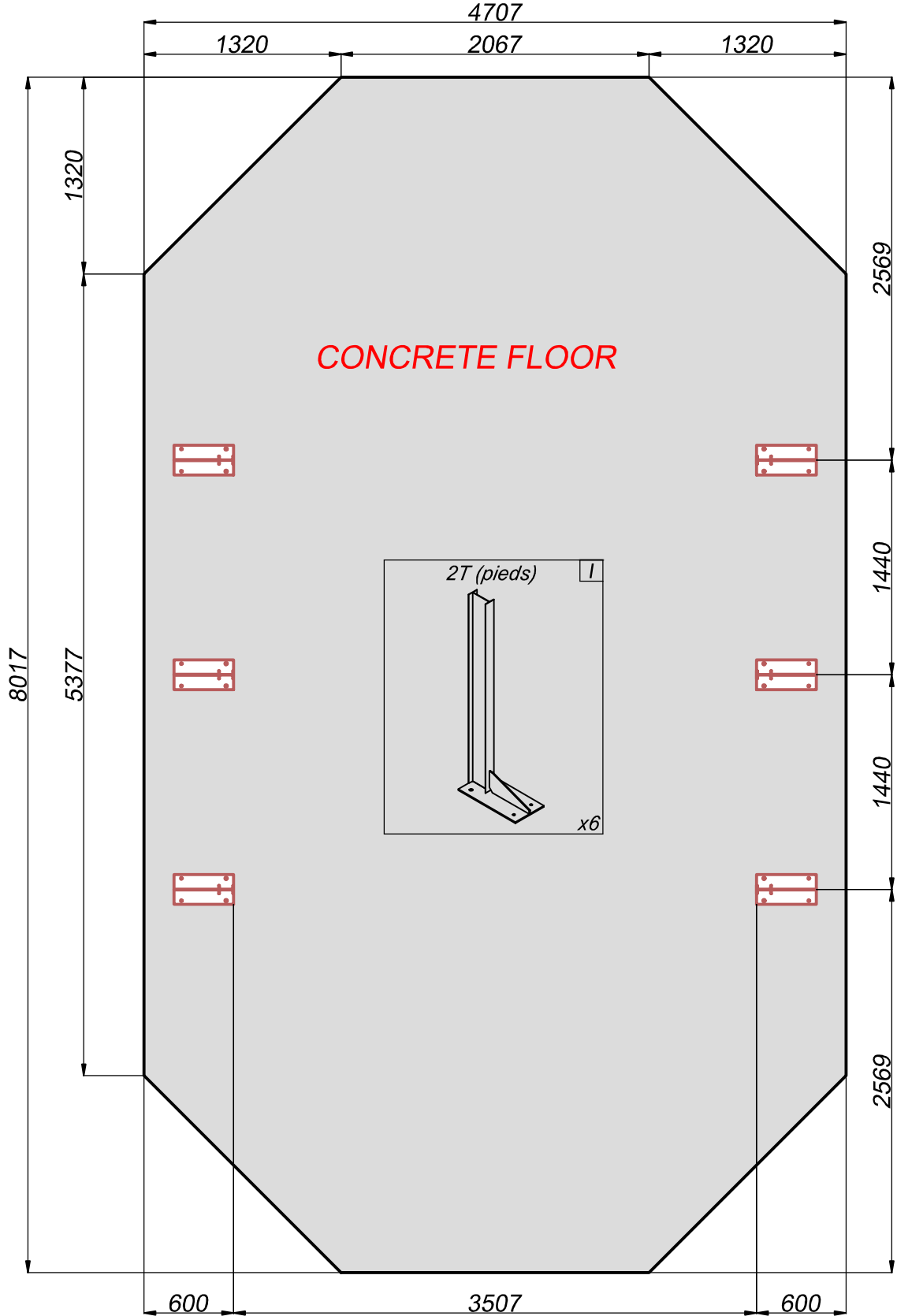



B (pieds)- opcja / option

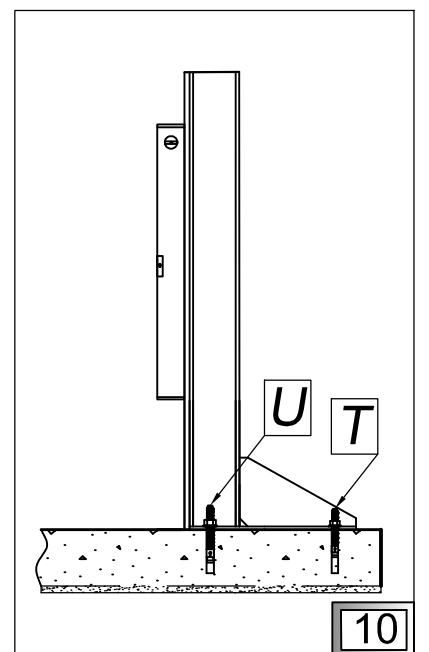
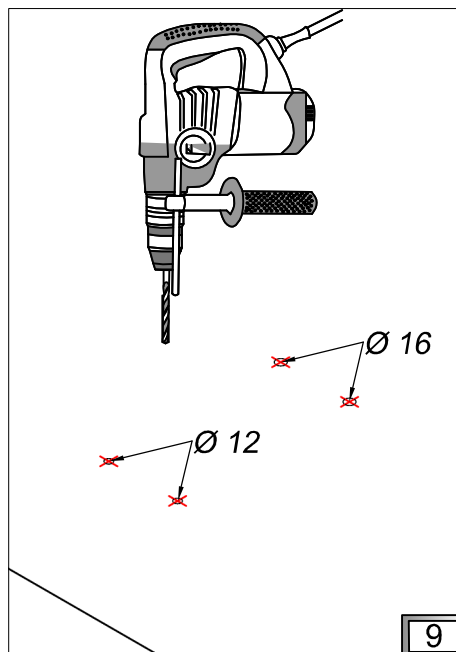
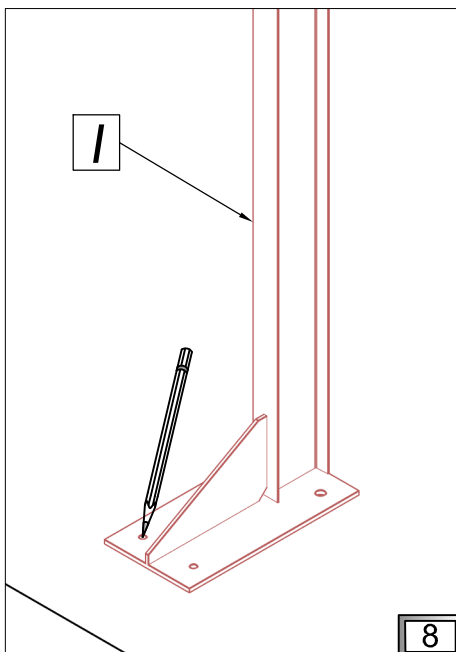
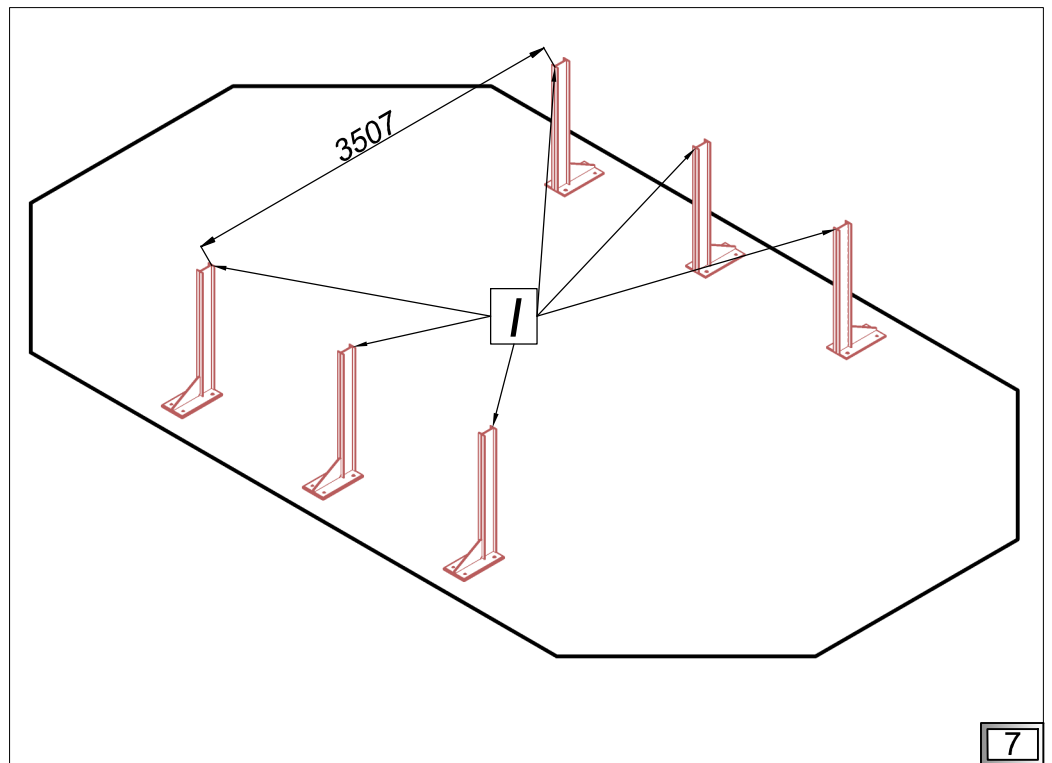
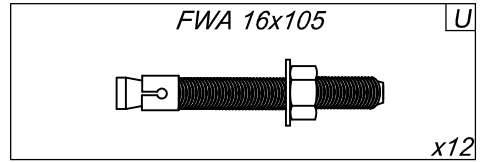
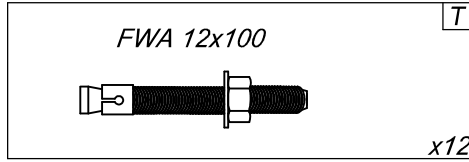
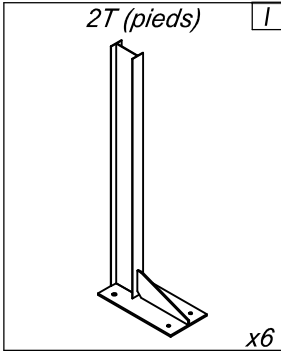

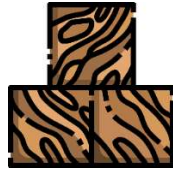

/

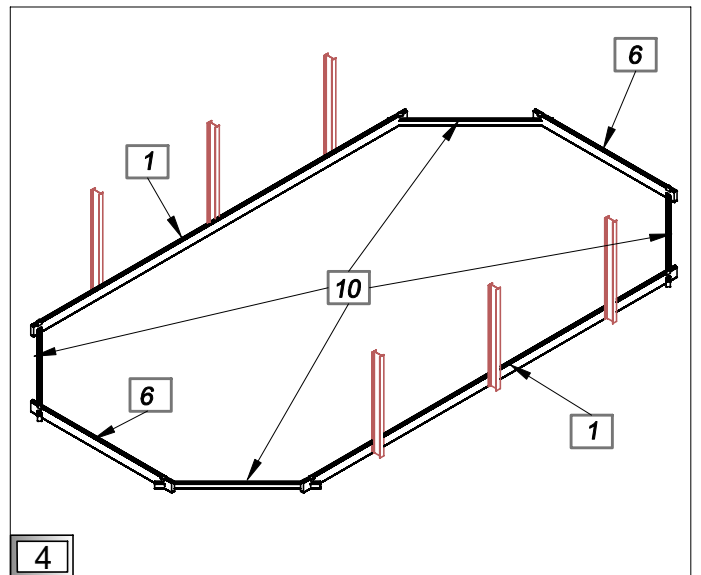
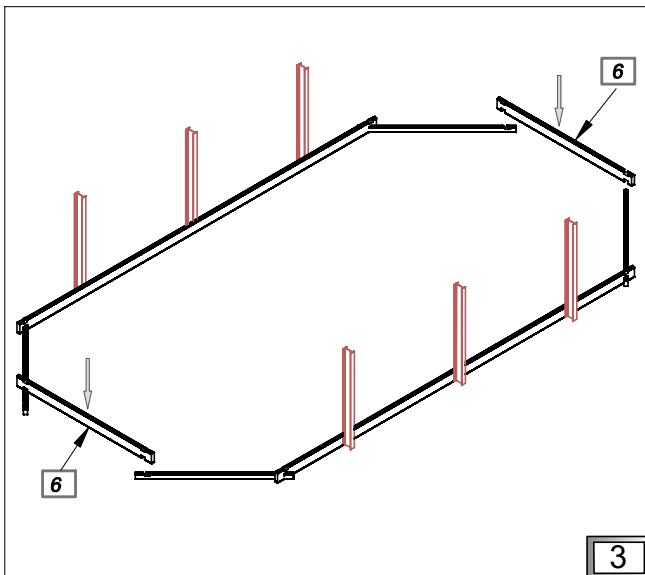
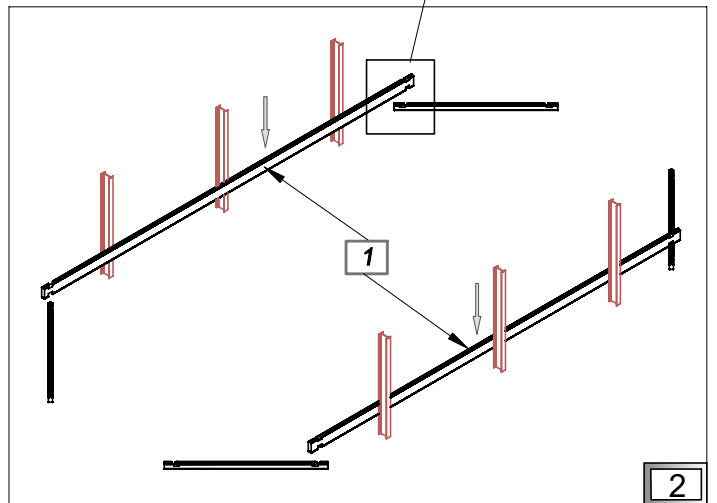
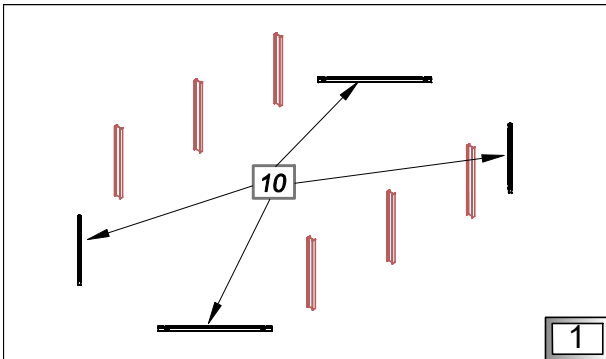
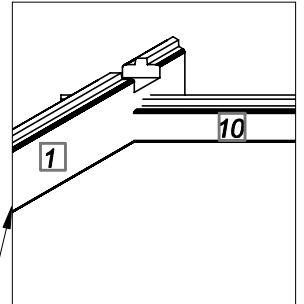
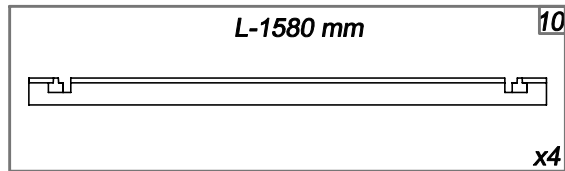
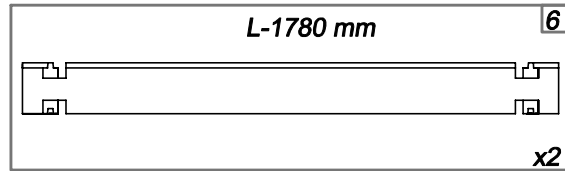
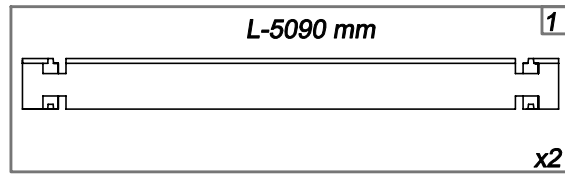
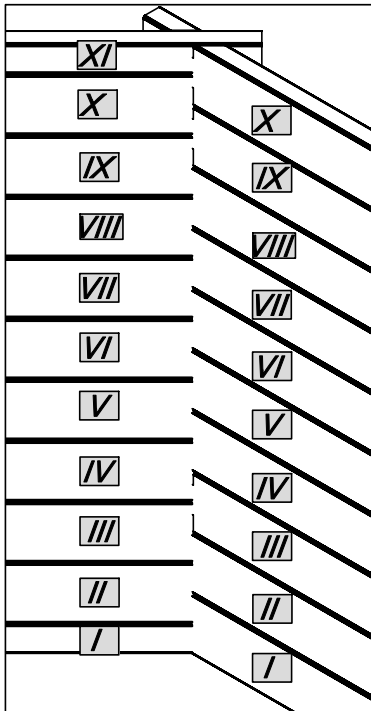



[mm]

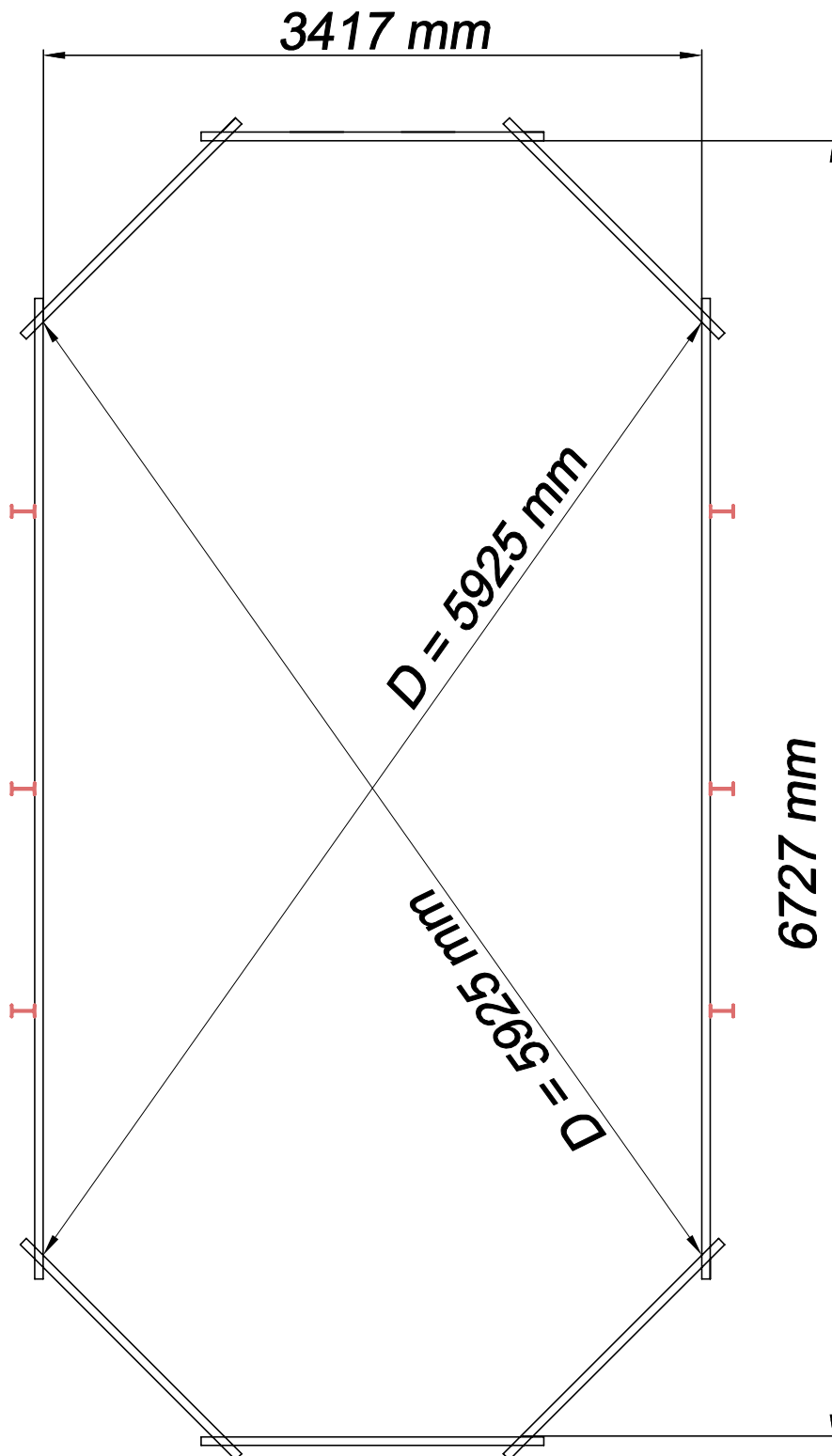



B (pieds) - opcja / option

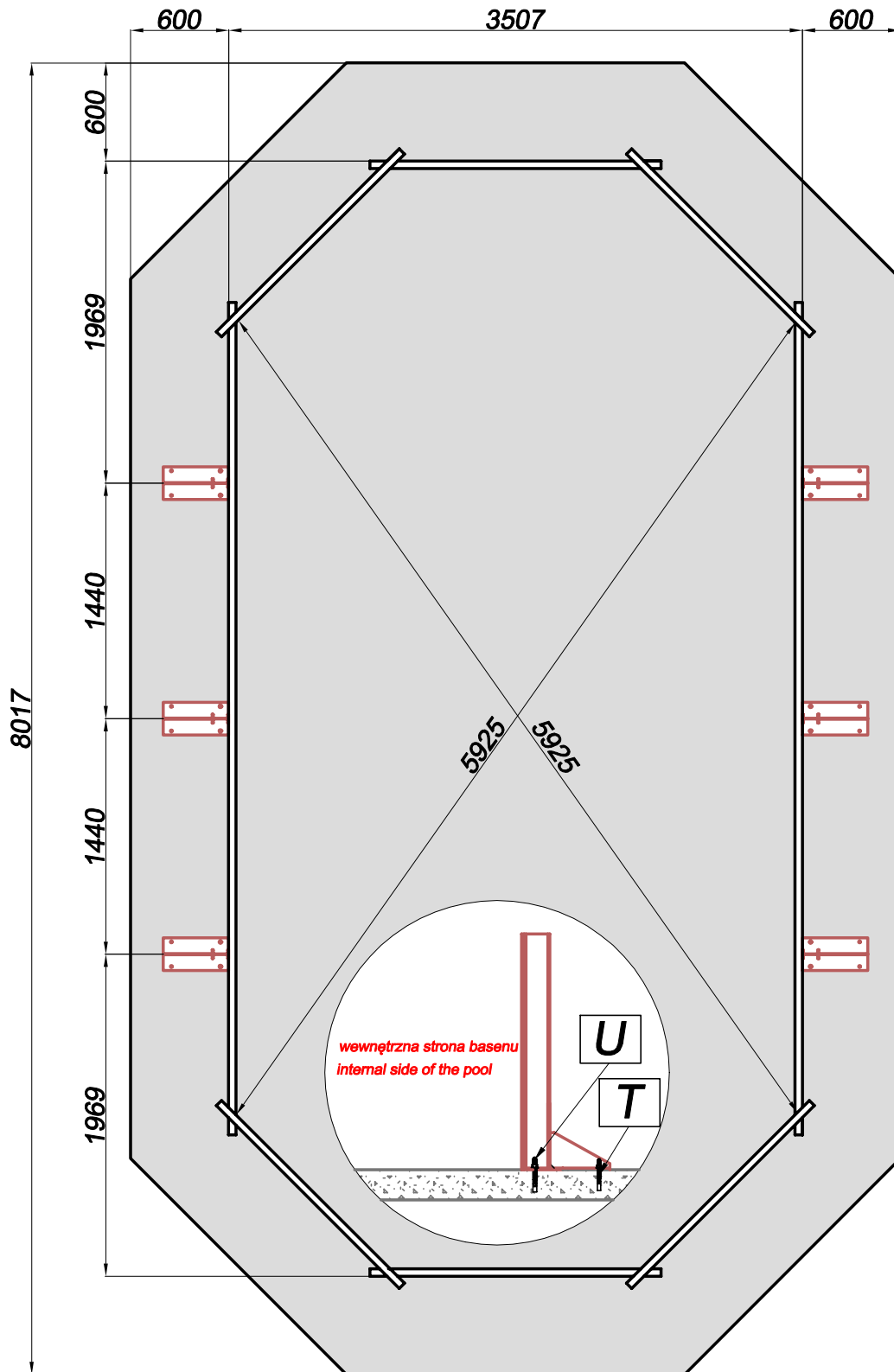



III-III

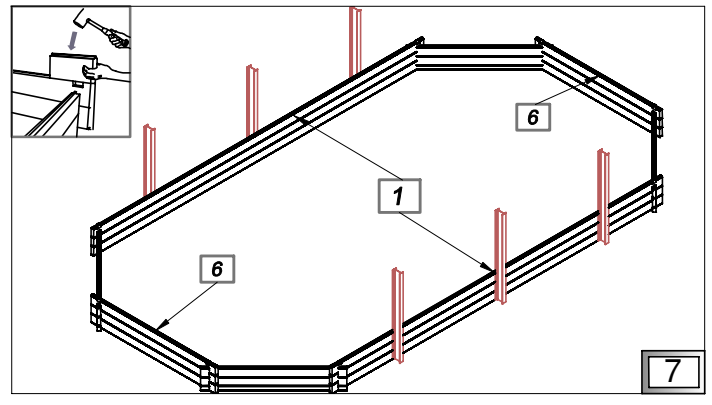
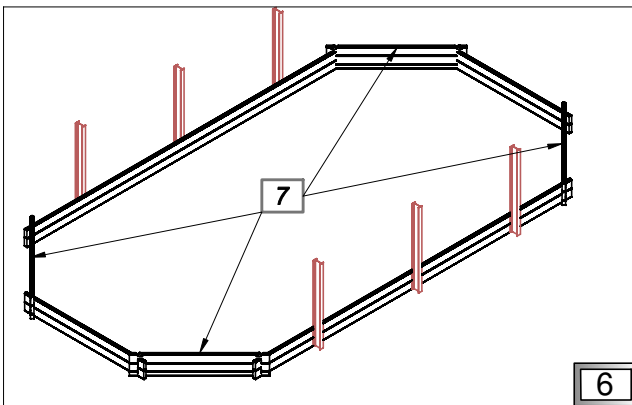
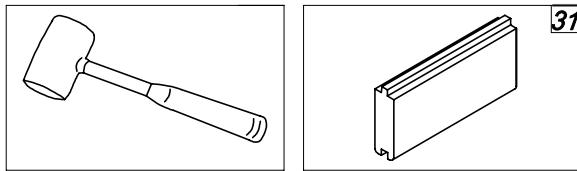
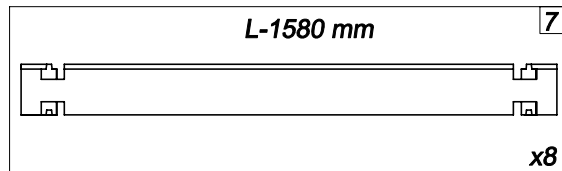
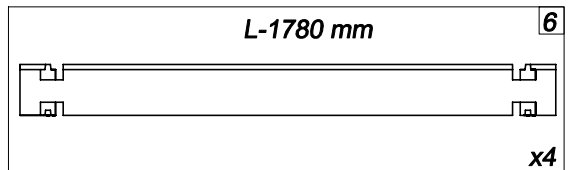
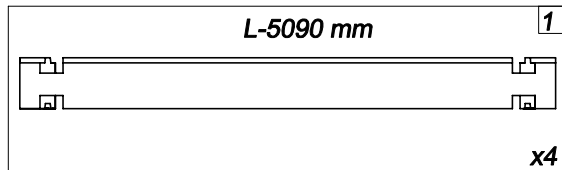

IV

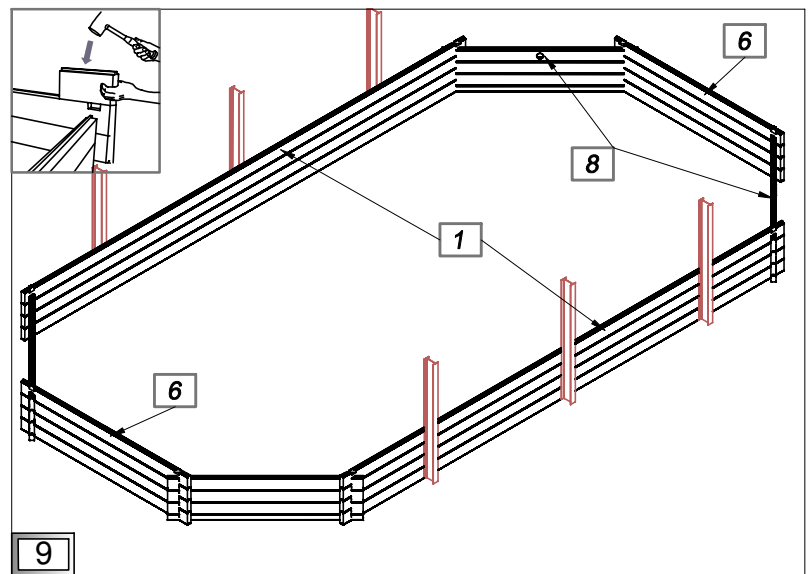
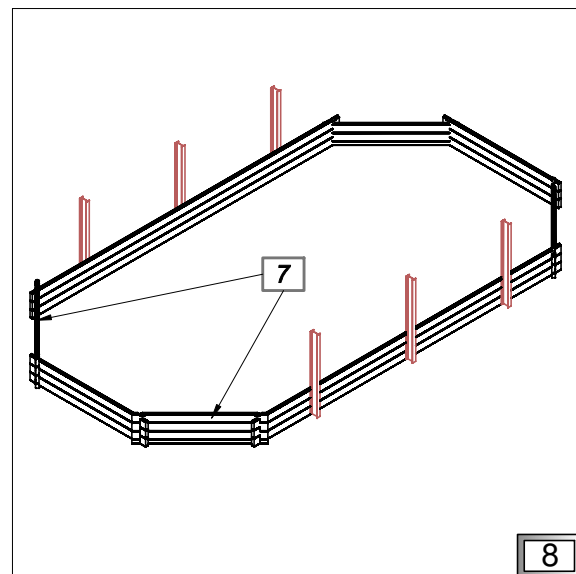
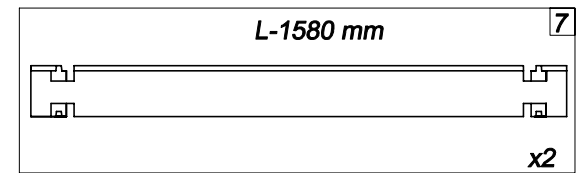
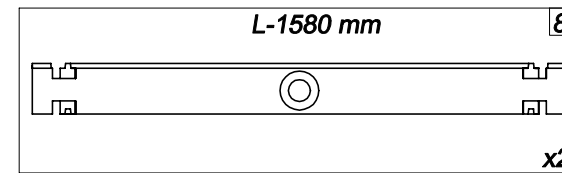
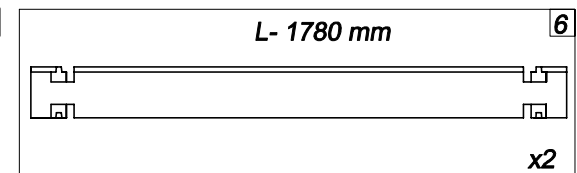
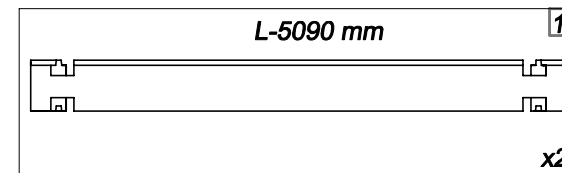



V-VIII

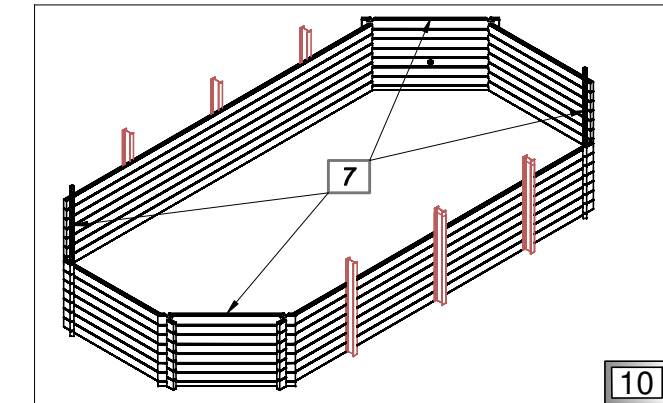
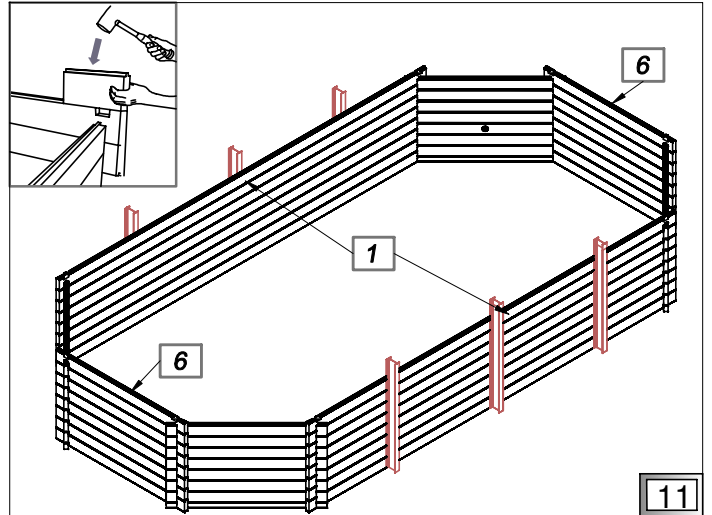
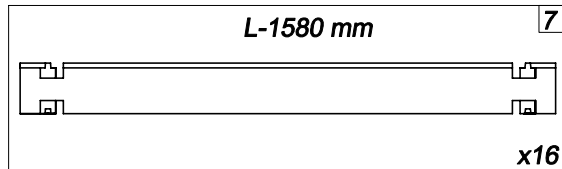
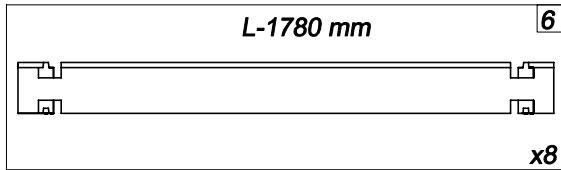
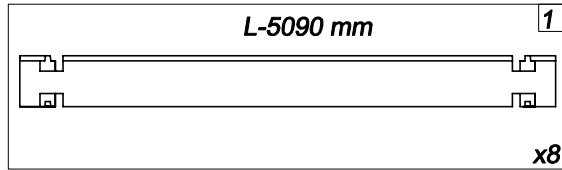

IX

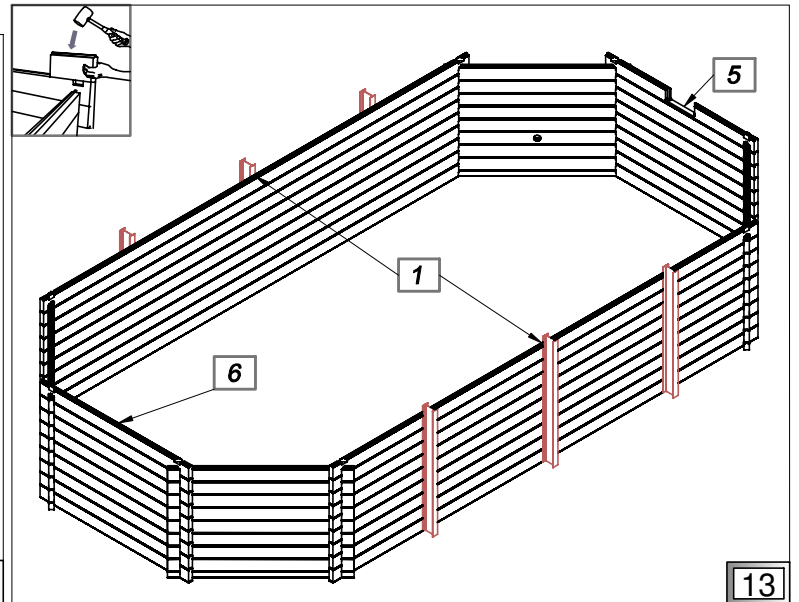
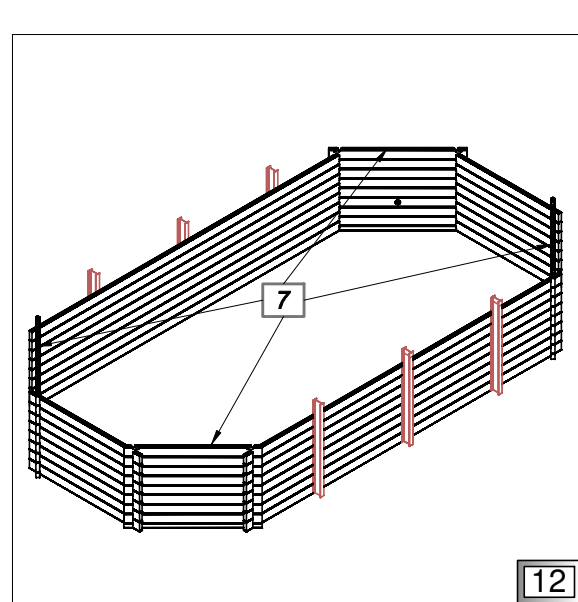
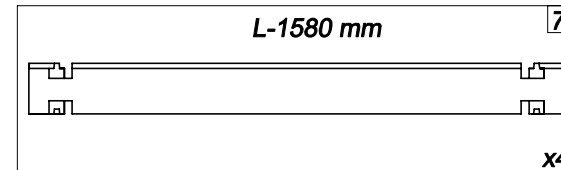
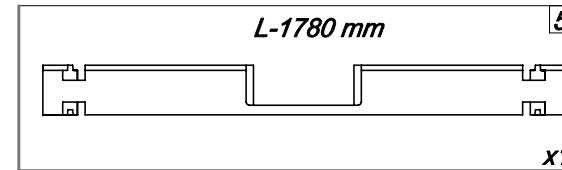
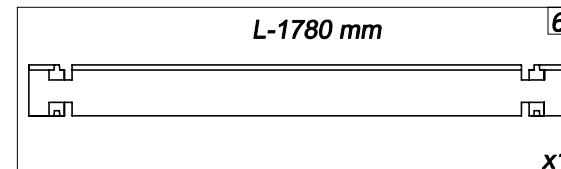
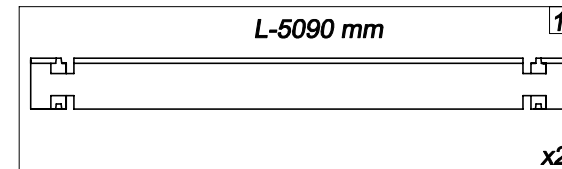

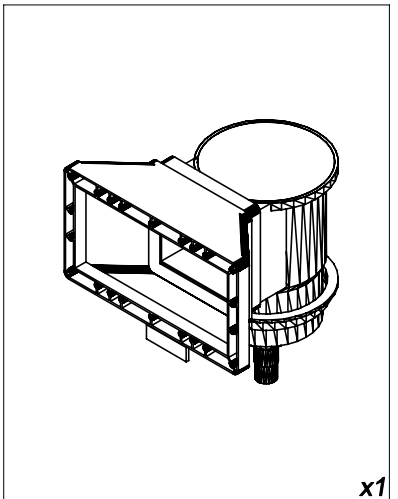
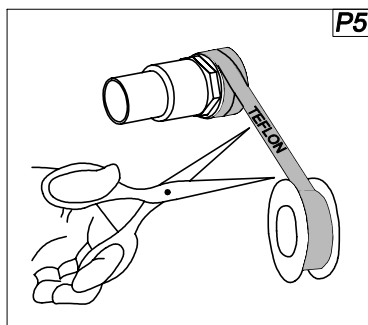
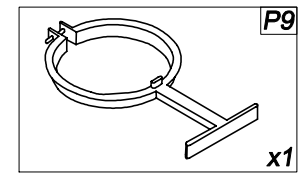
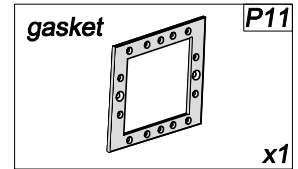
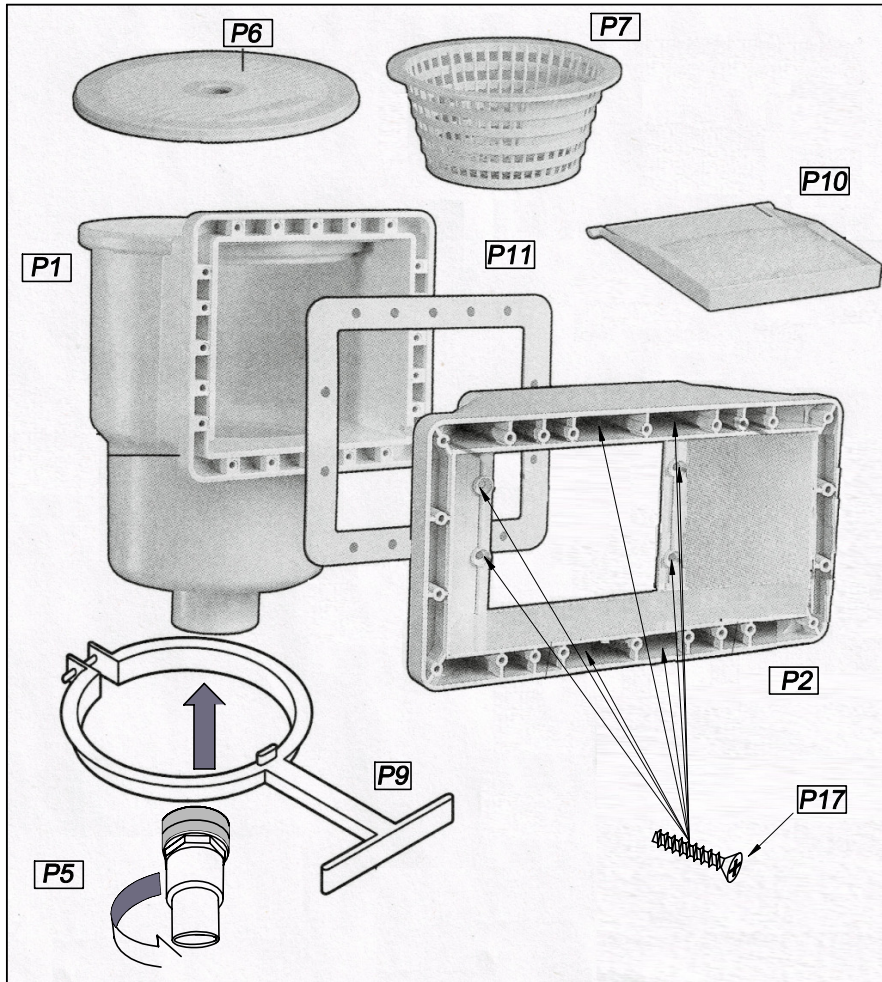
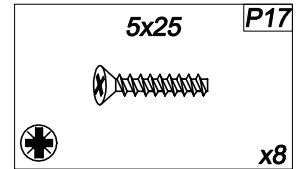
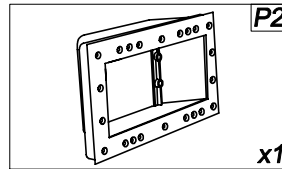
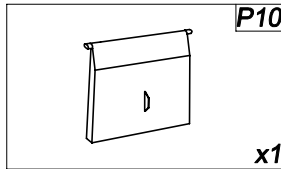
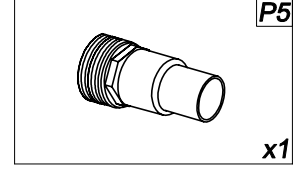
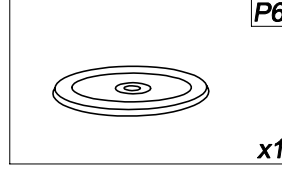
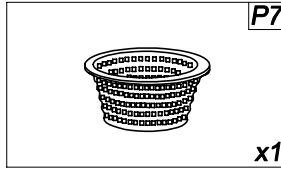
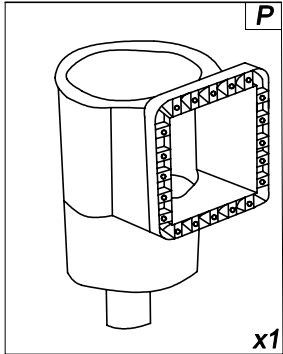



L-5090 mm

2

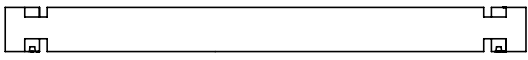

x2

L-1780 mm

3

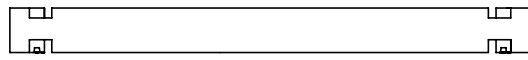

x1

L-1780 mm

4

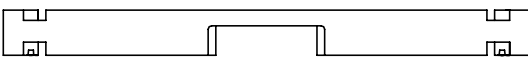

x1

L-1580 mm

7

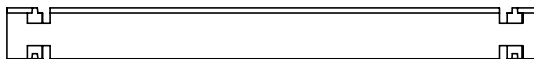

x4

Skimmer

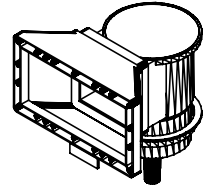

x1

X

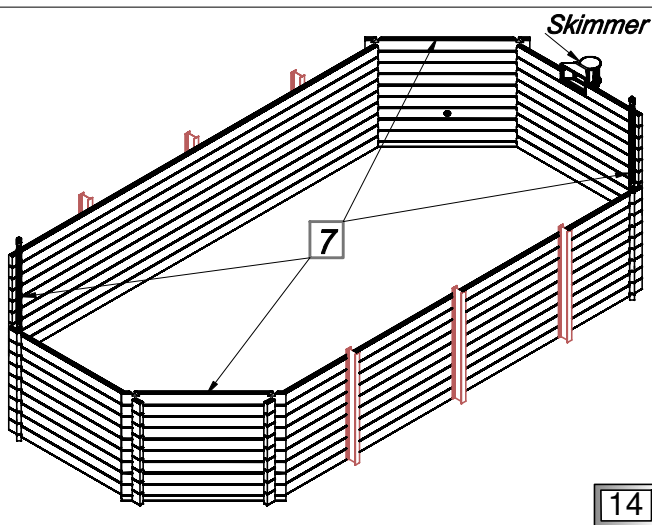

14

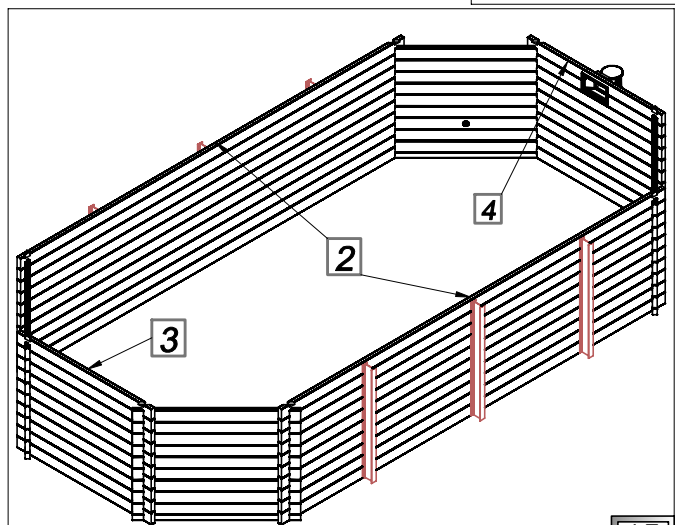

15

L-1580 mm

9

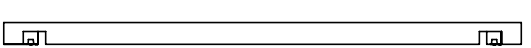

x4

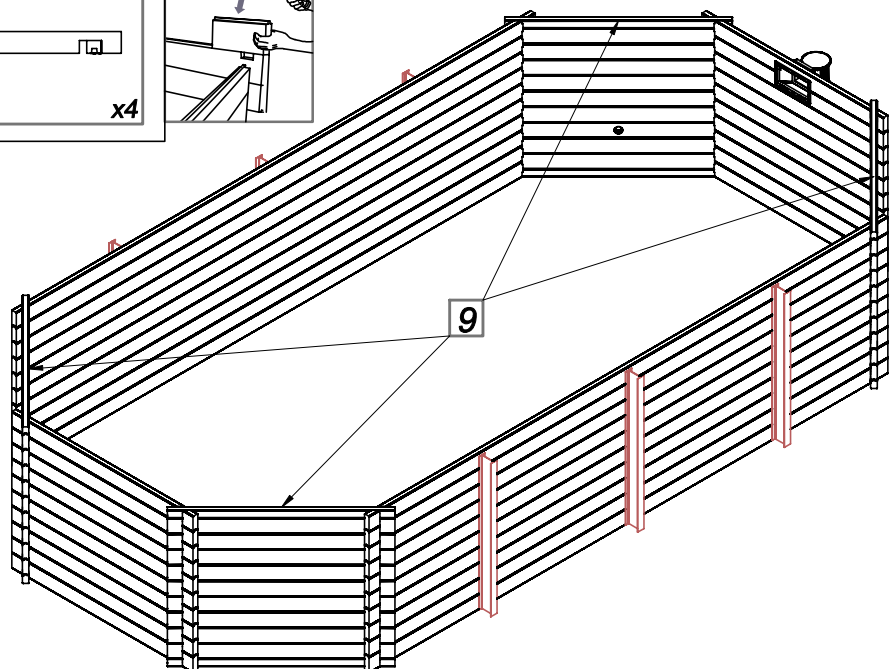
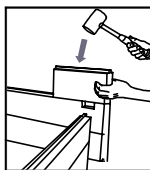

16

XI

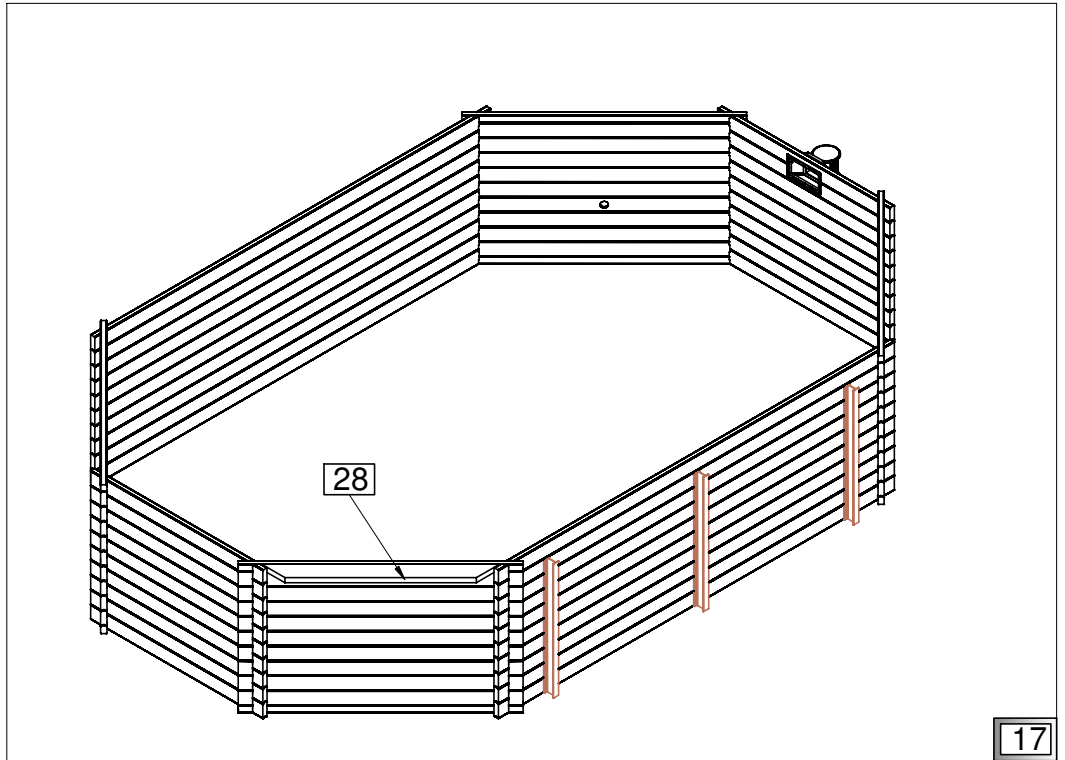
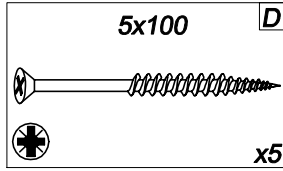
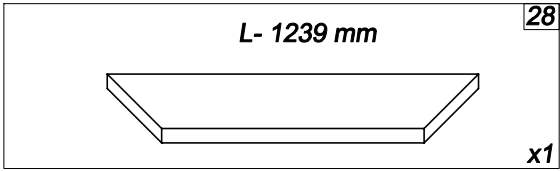

17

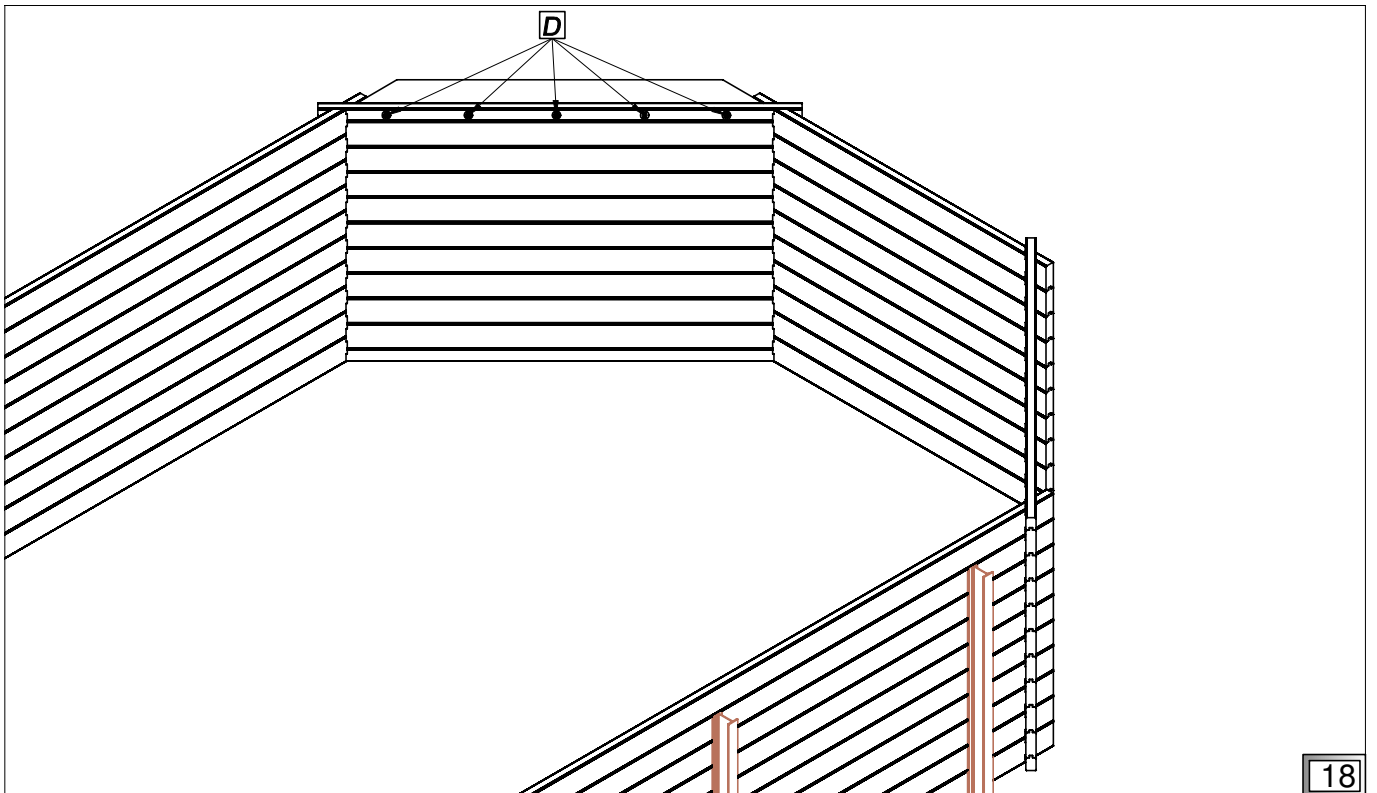

18

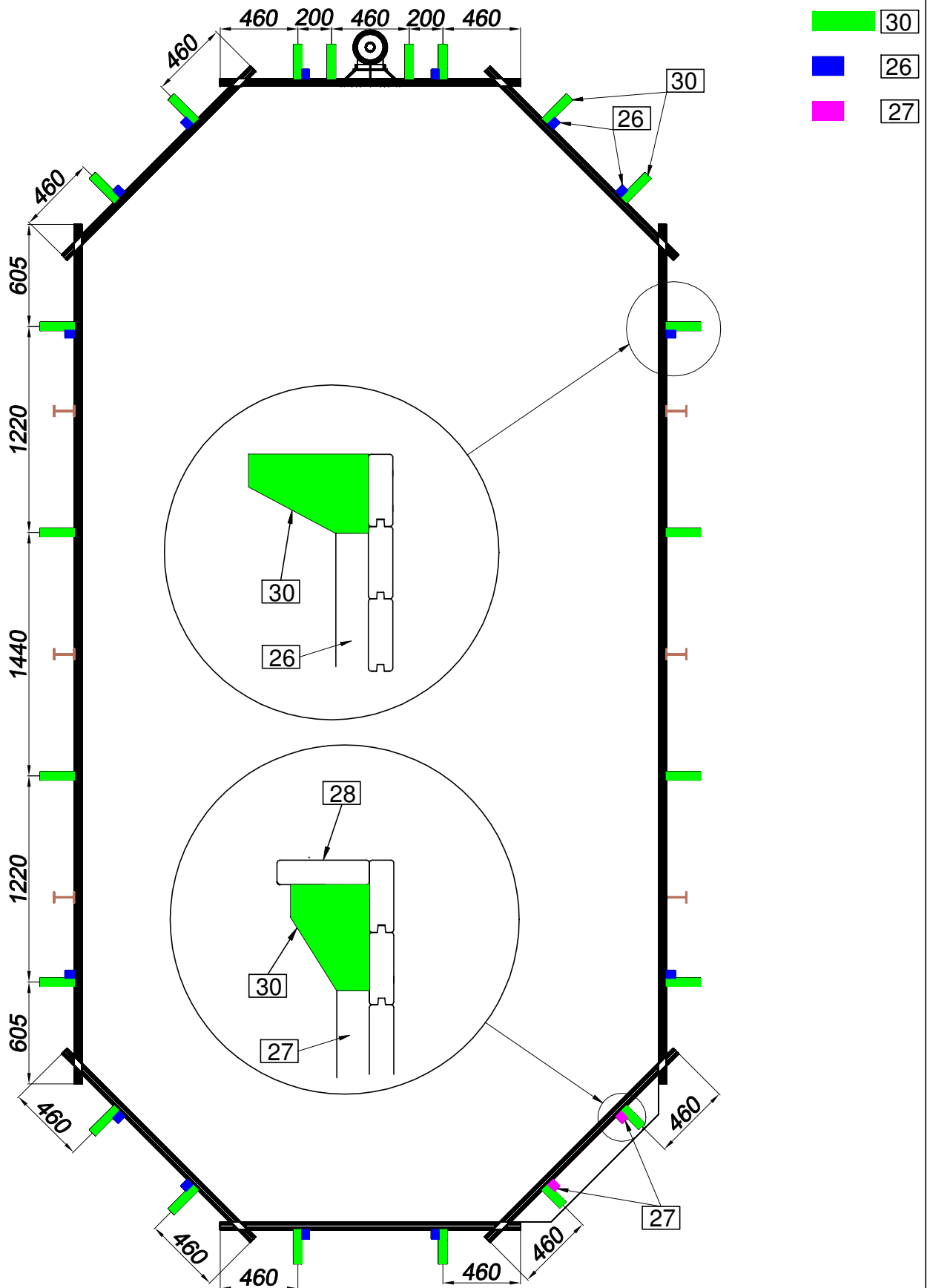

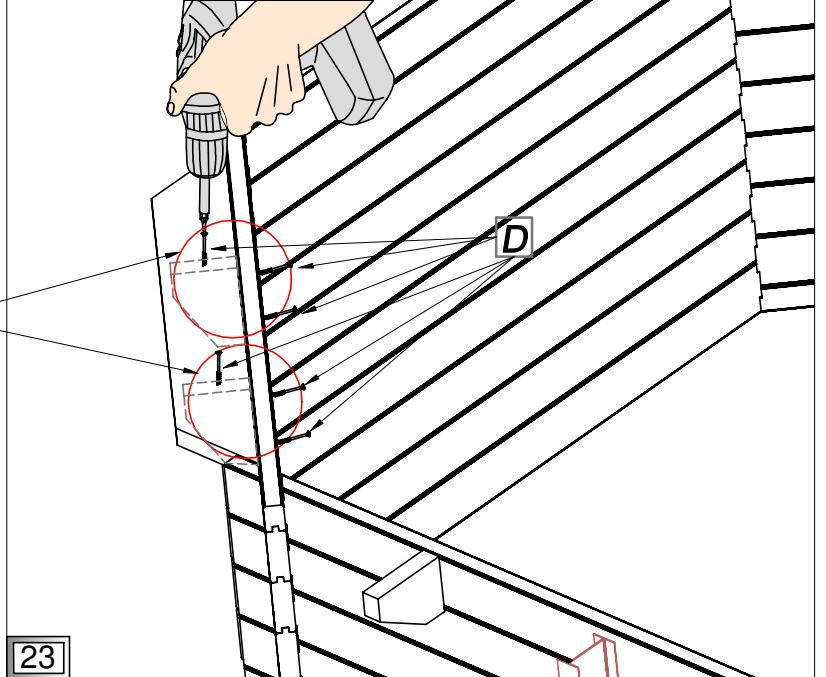
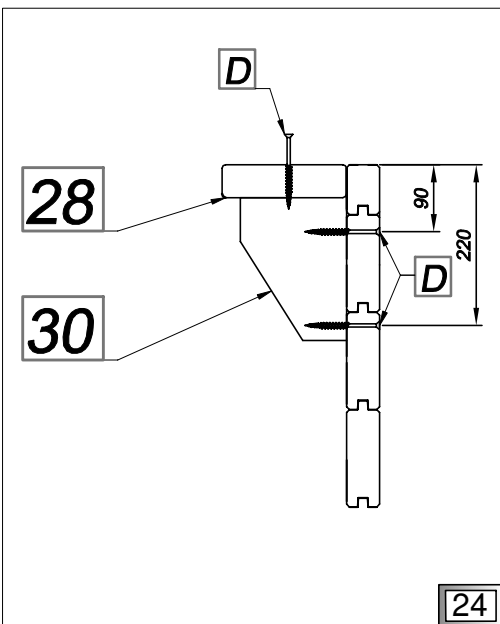
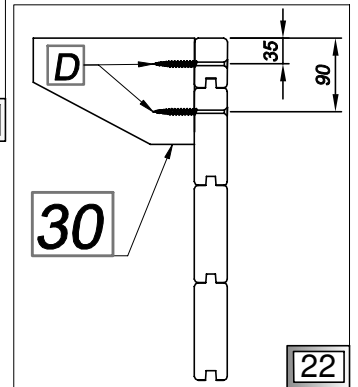
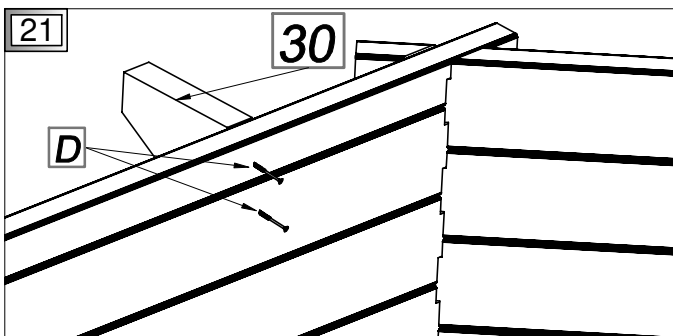
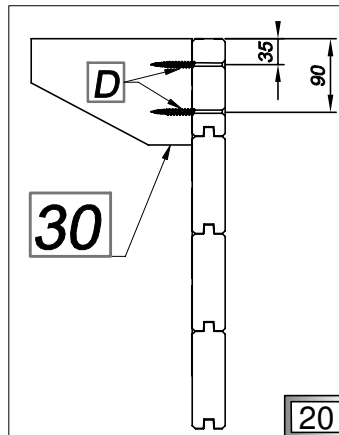
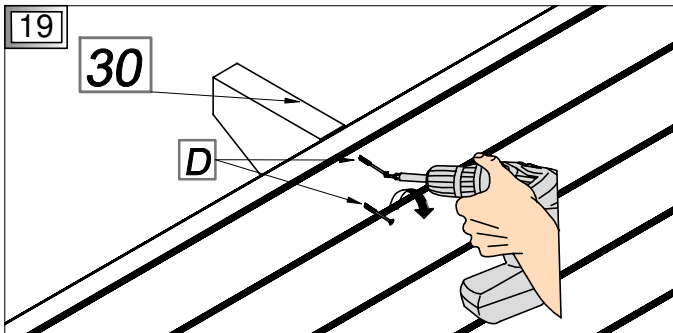
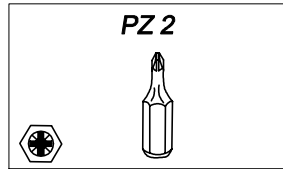
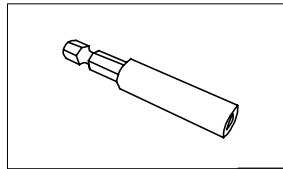
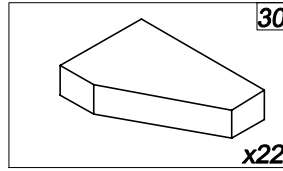
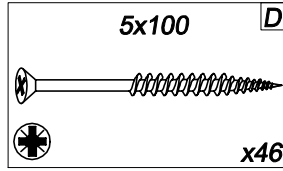
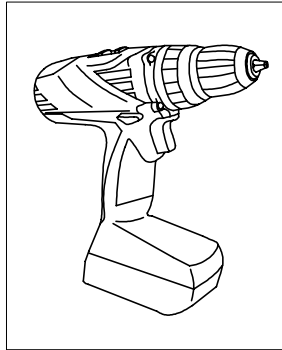

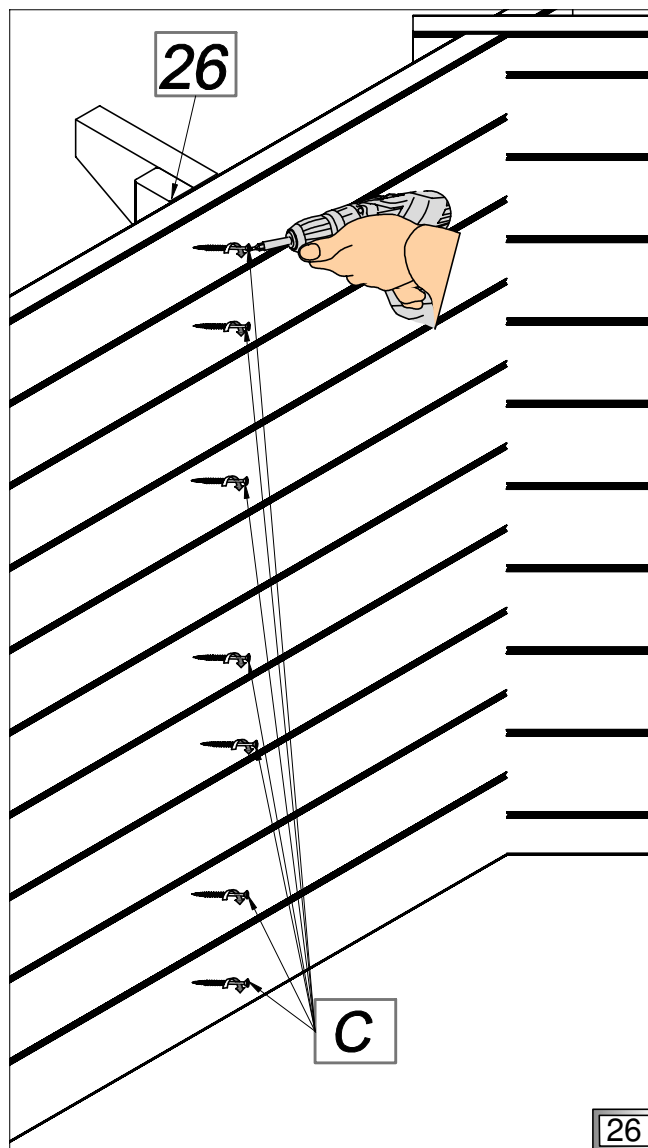
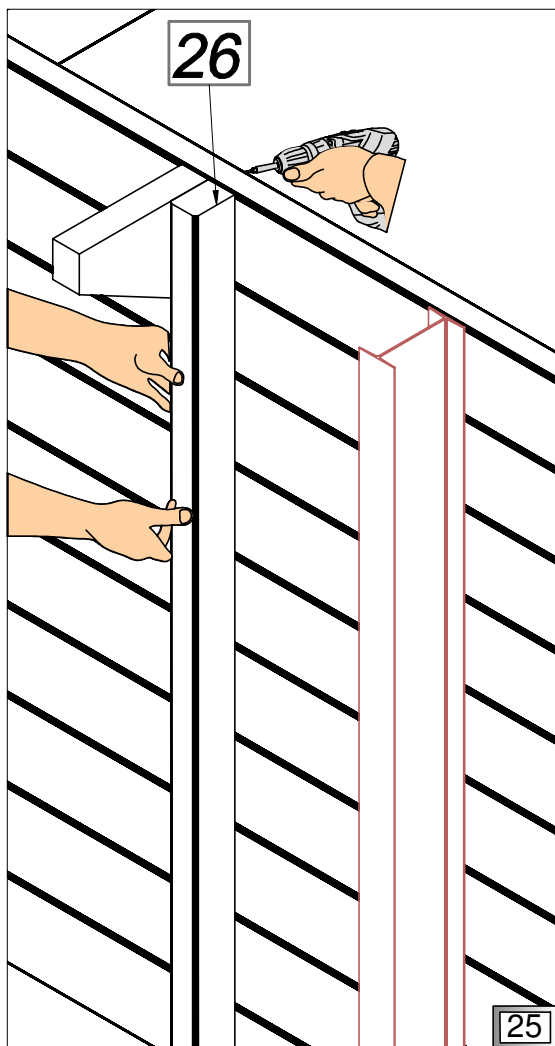
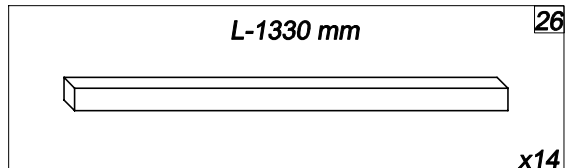
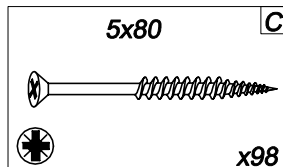
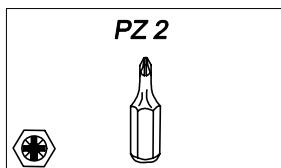
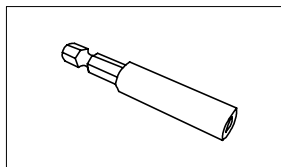
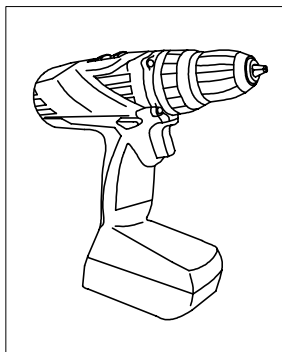

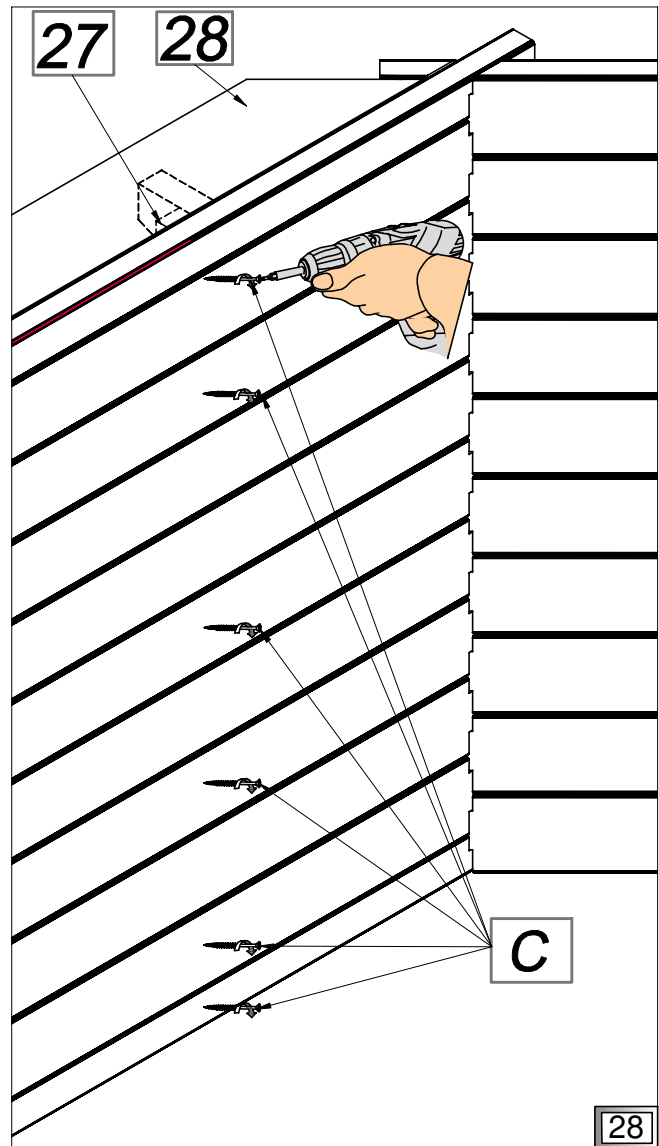
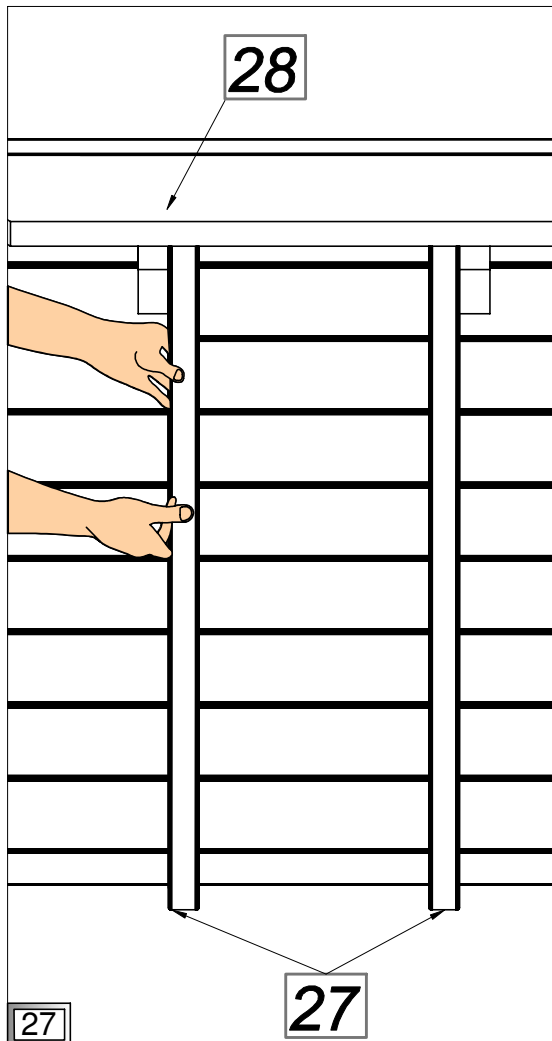
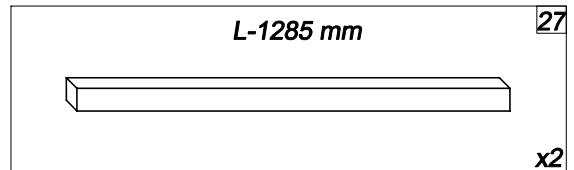
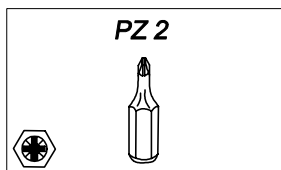
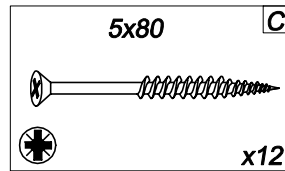
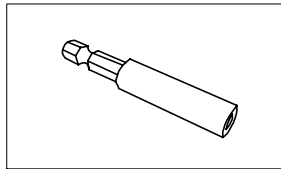
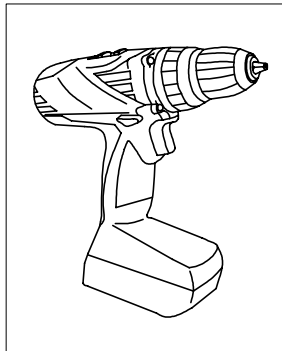

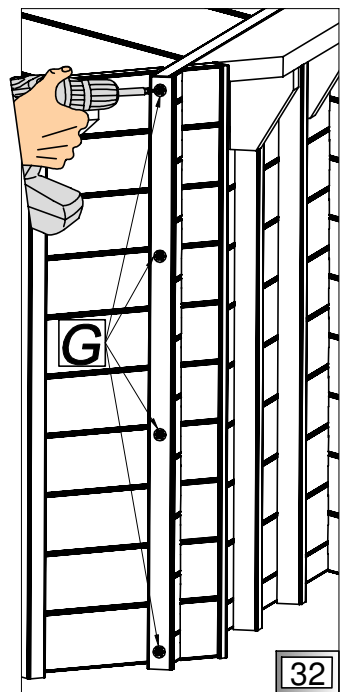
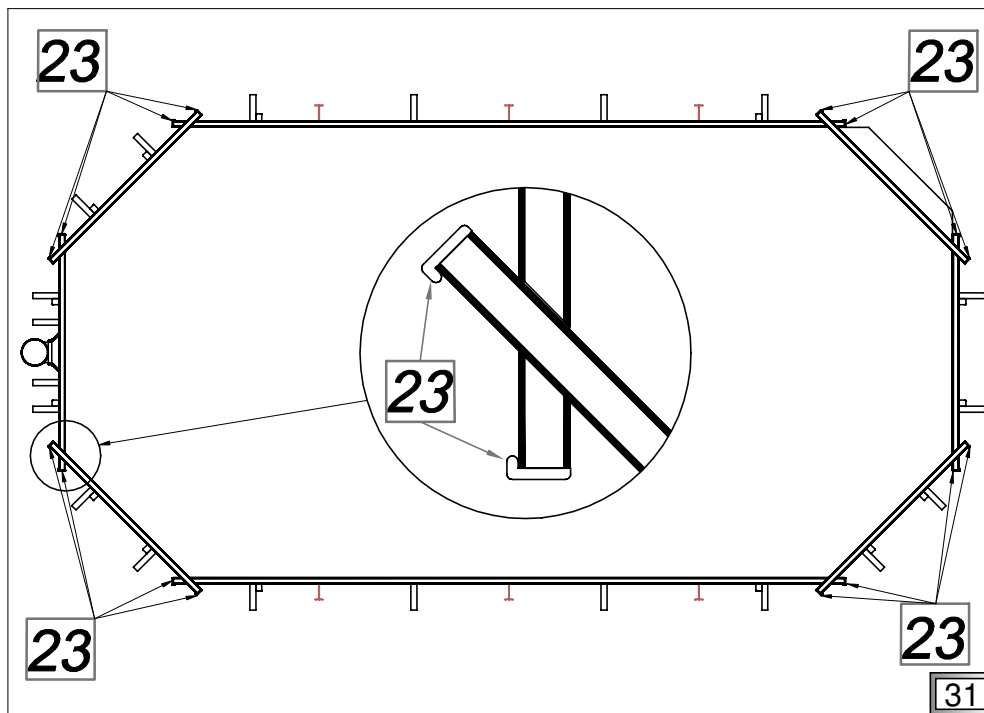
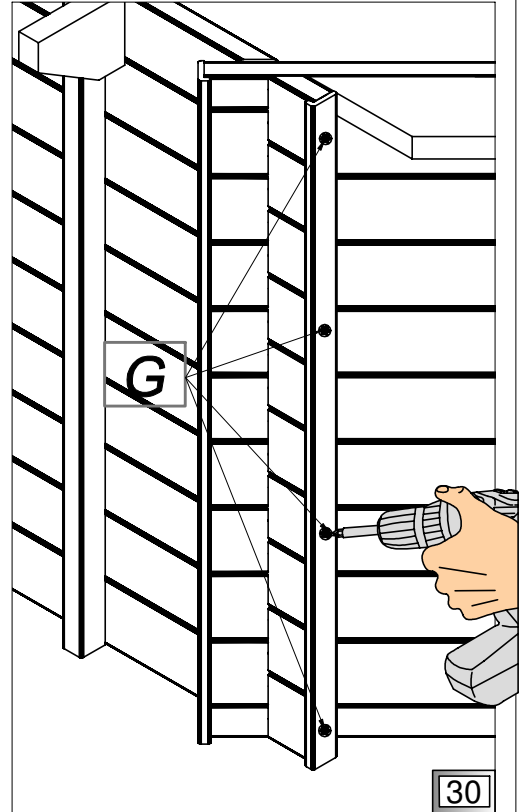
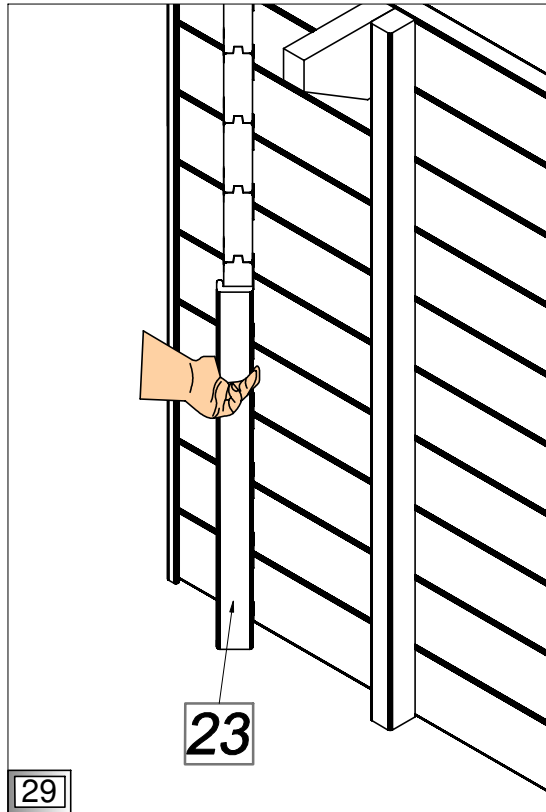
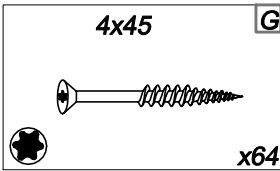
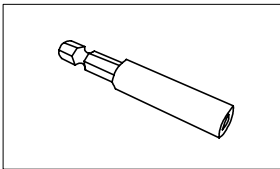
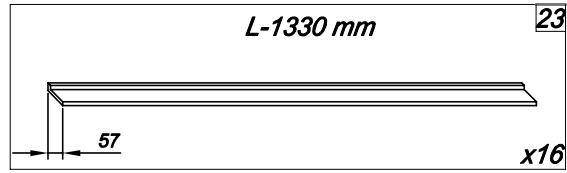
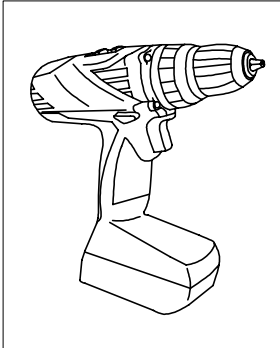

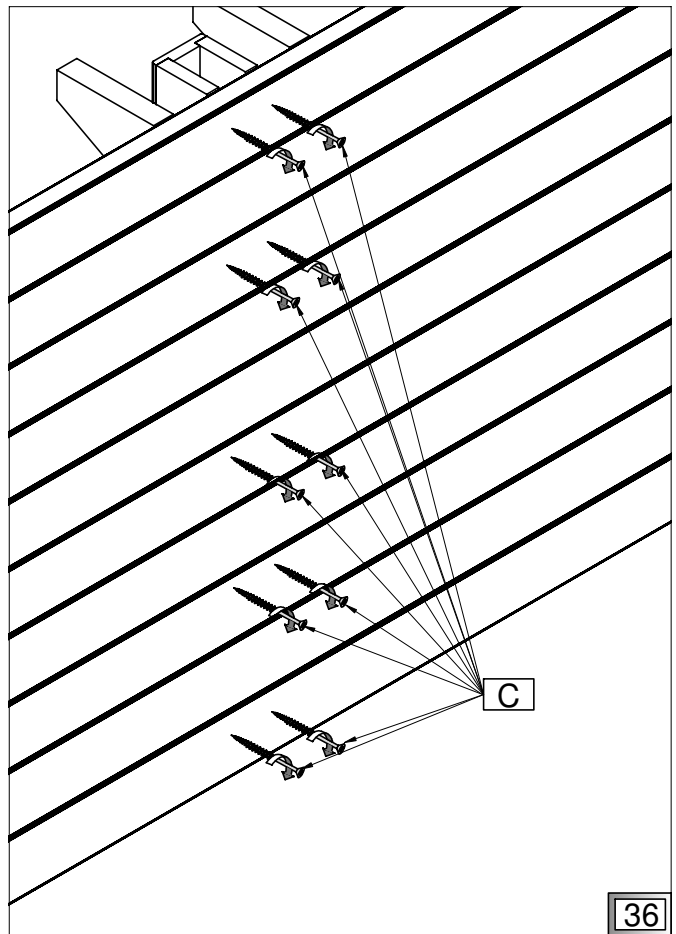
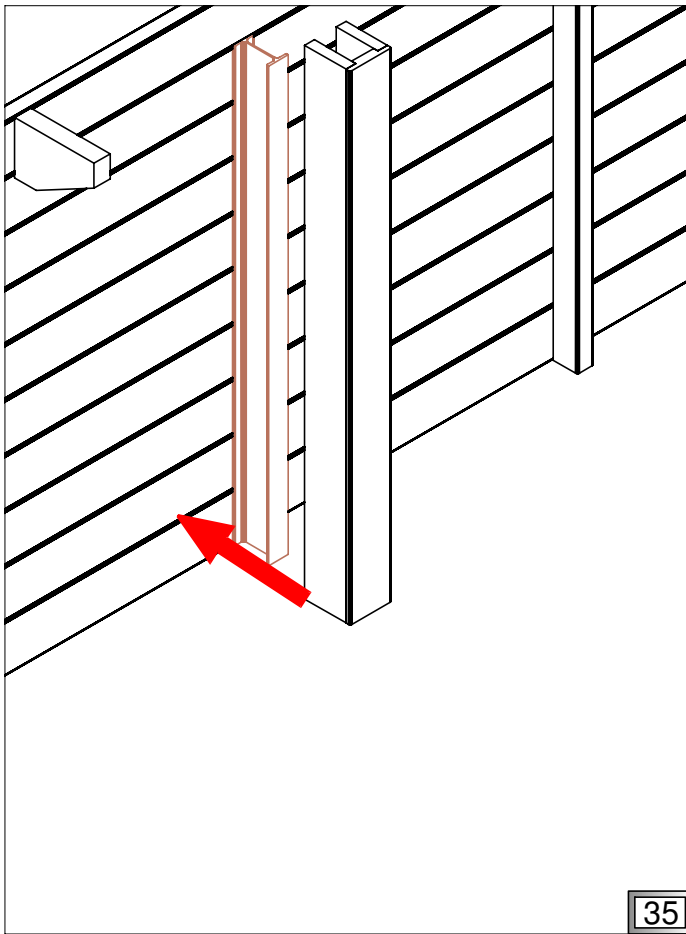
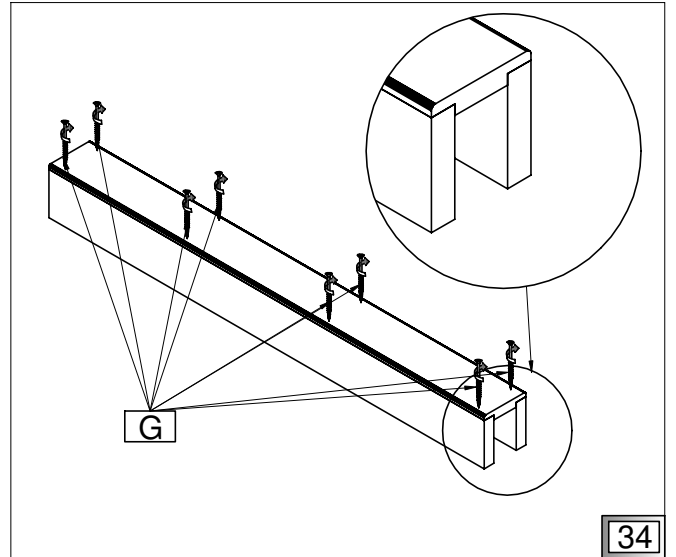
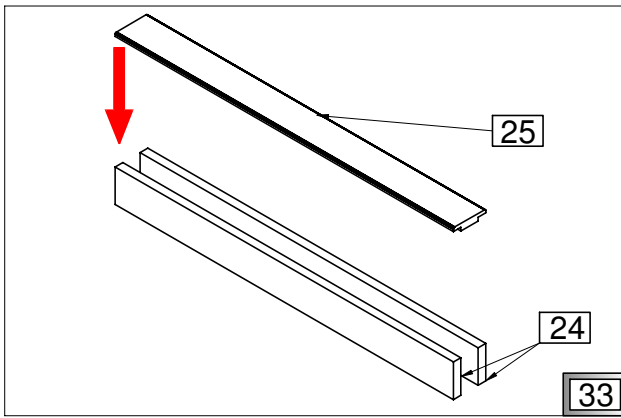
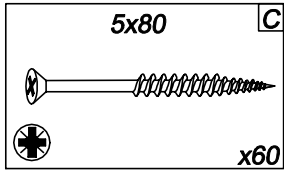
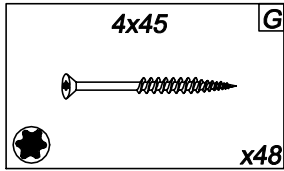
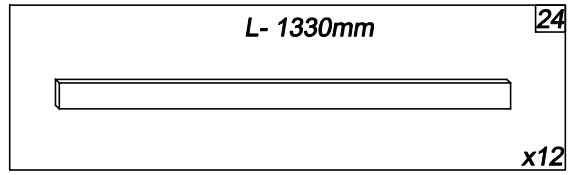
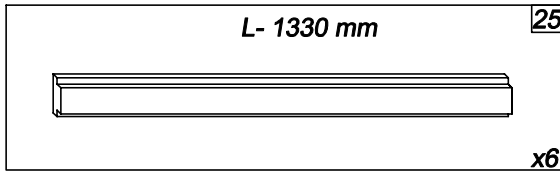

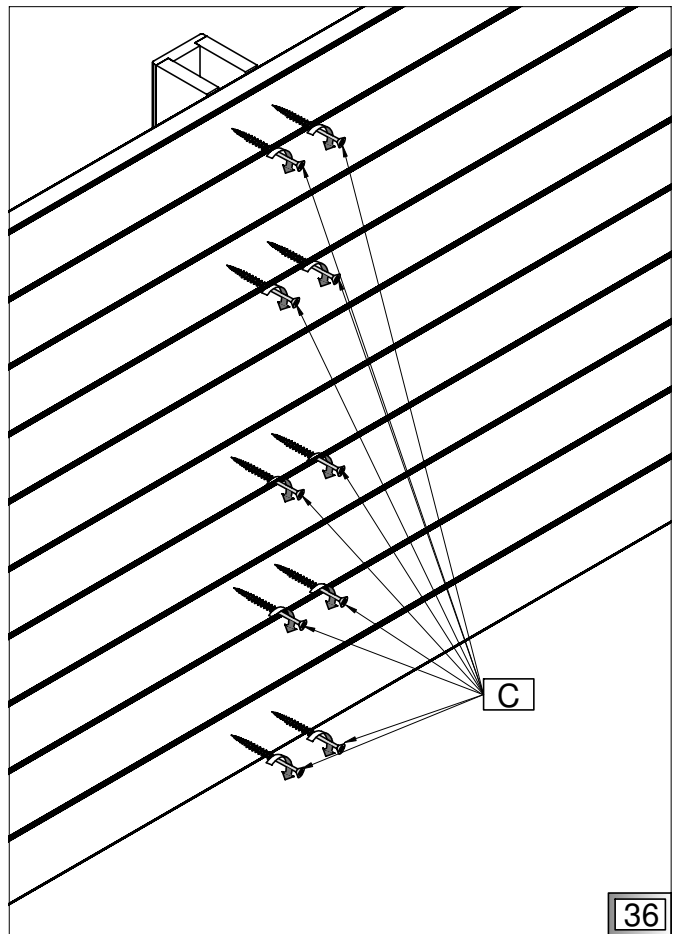
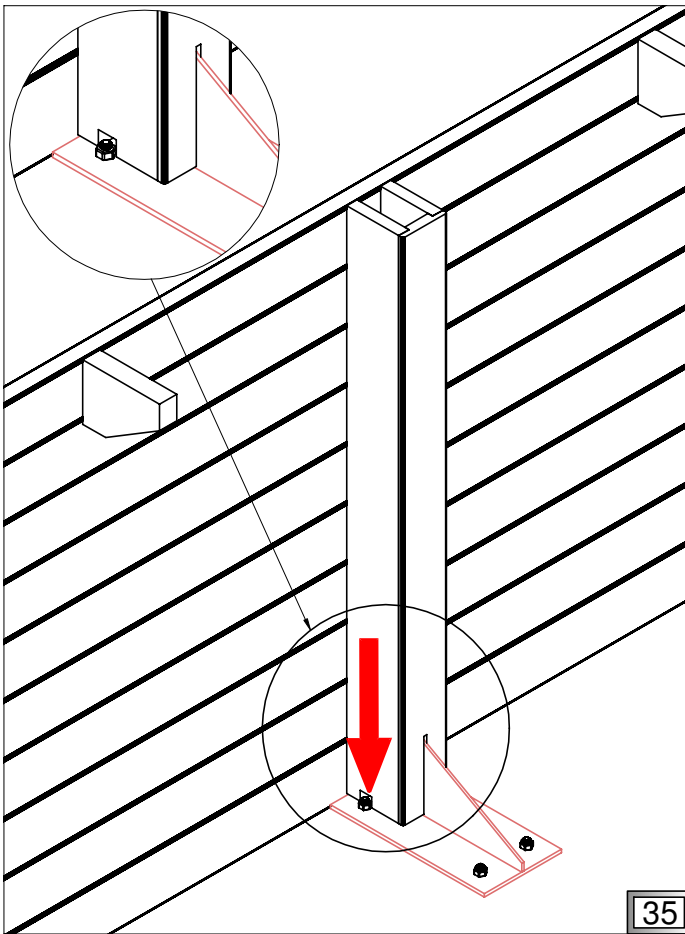
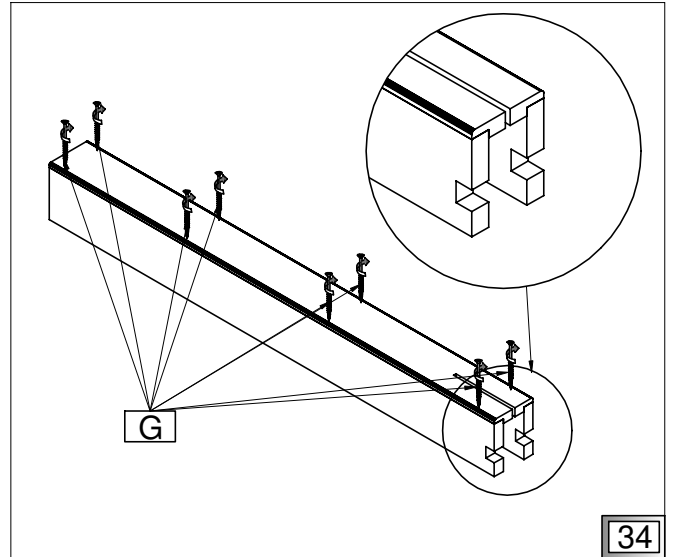
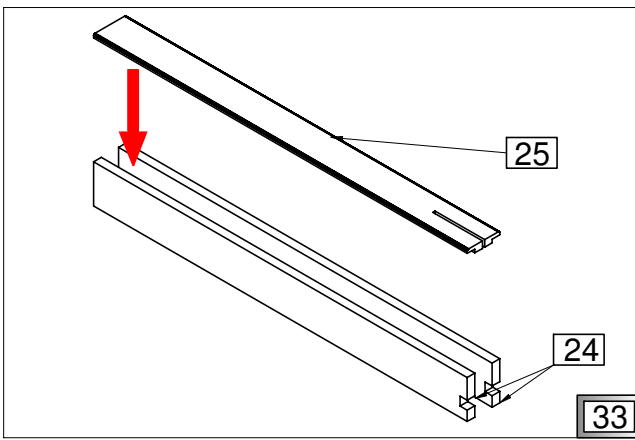
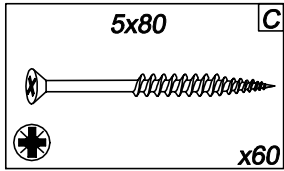
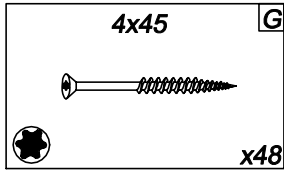
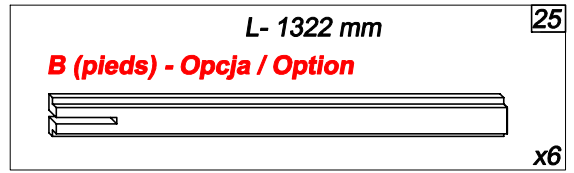
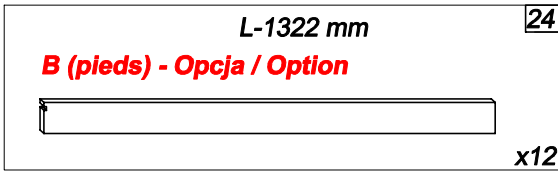

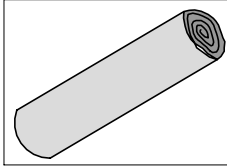

S

x1

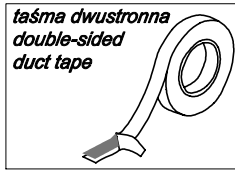

taśma dwustronna
double-sided
duct tape

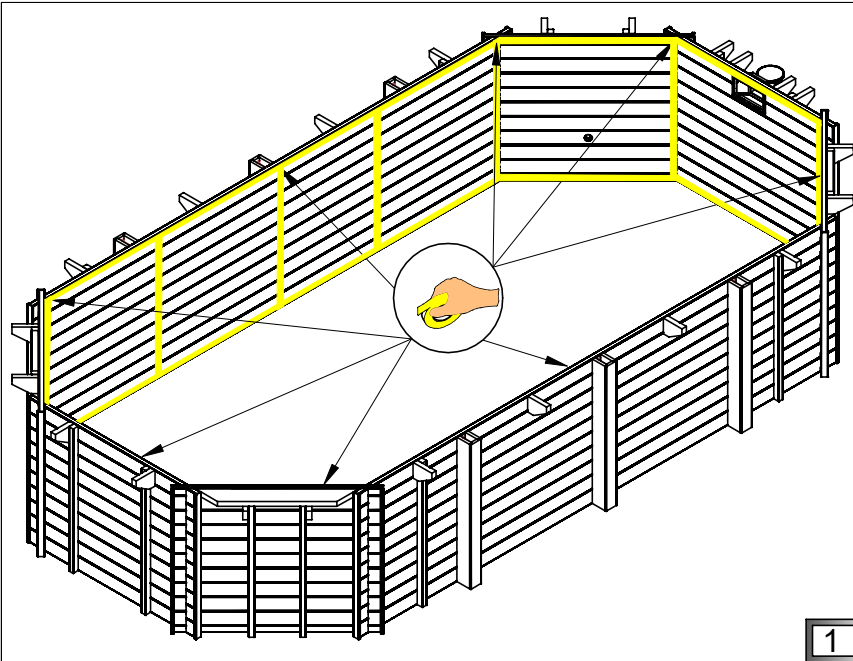
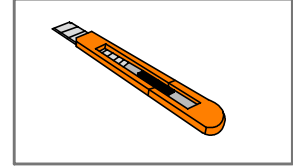
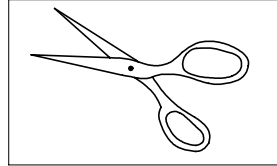

1

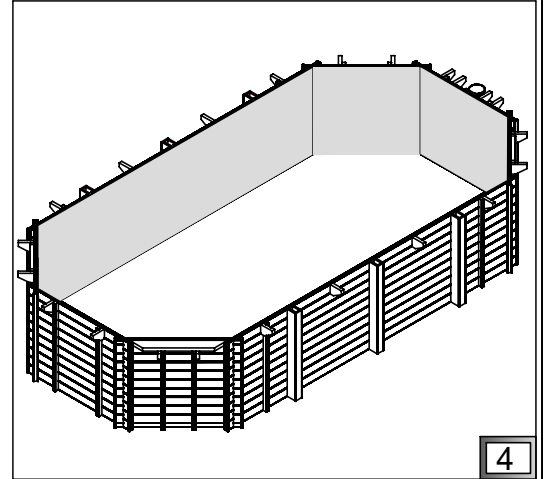

4

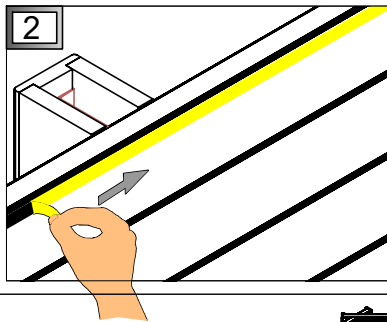

2

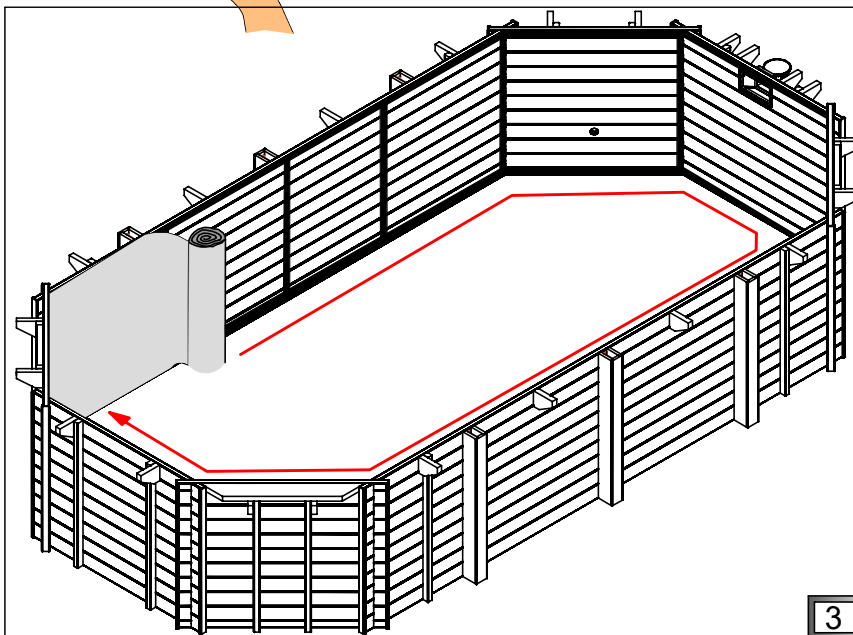

3

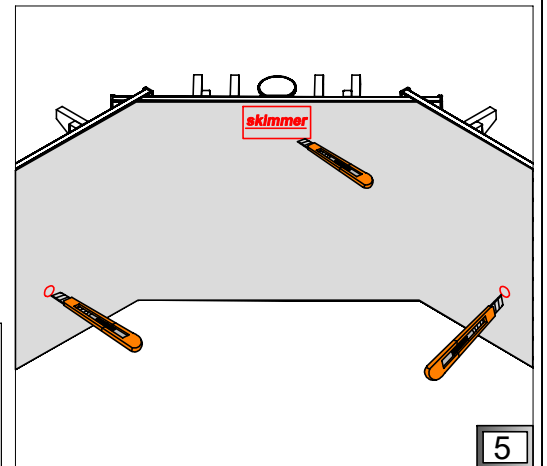

5

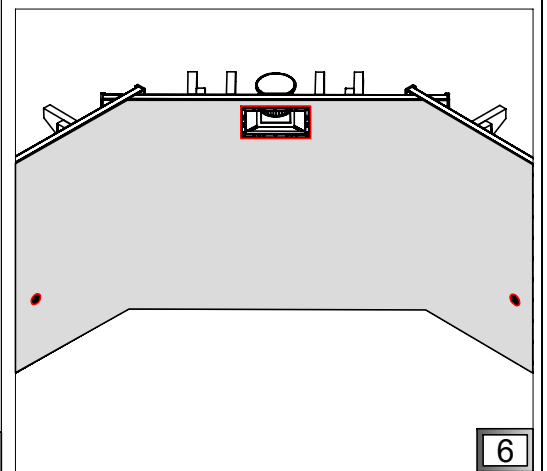

6

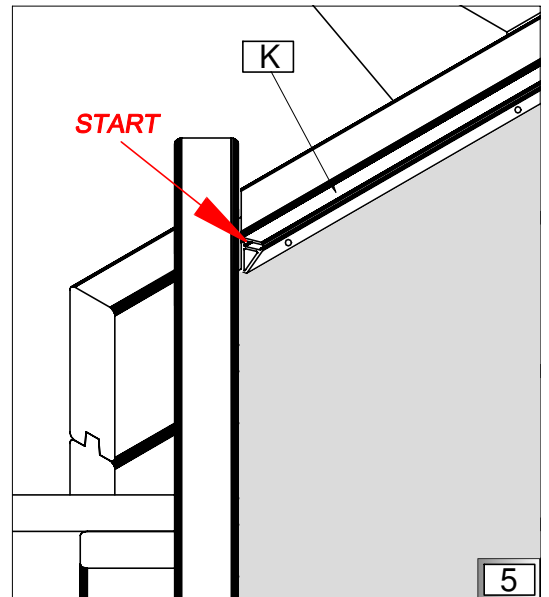
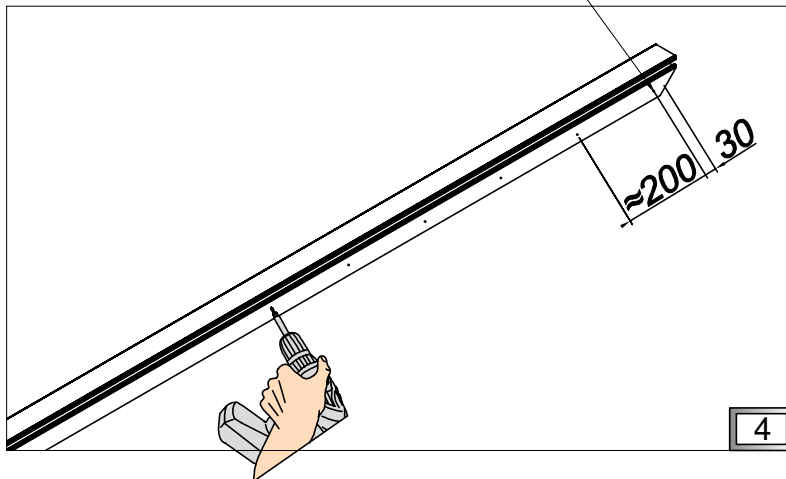
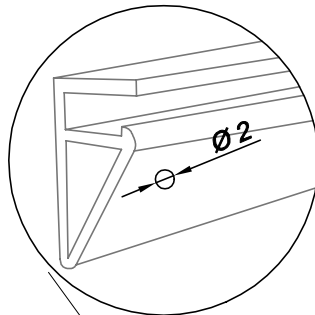
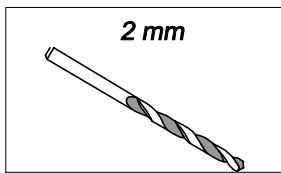
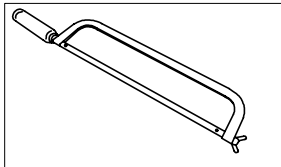
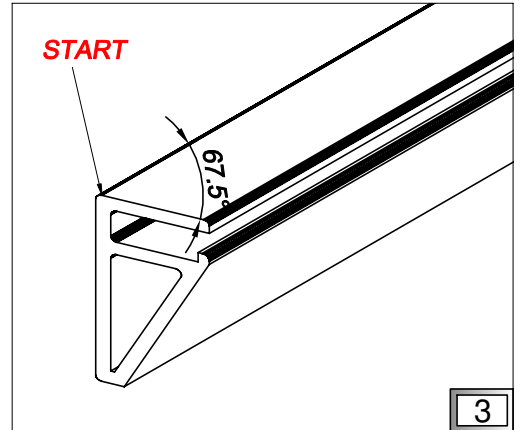
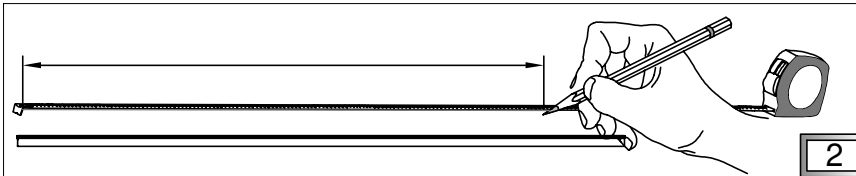
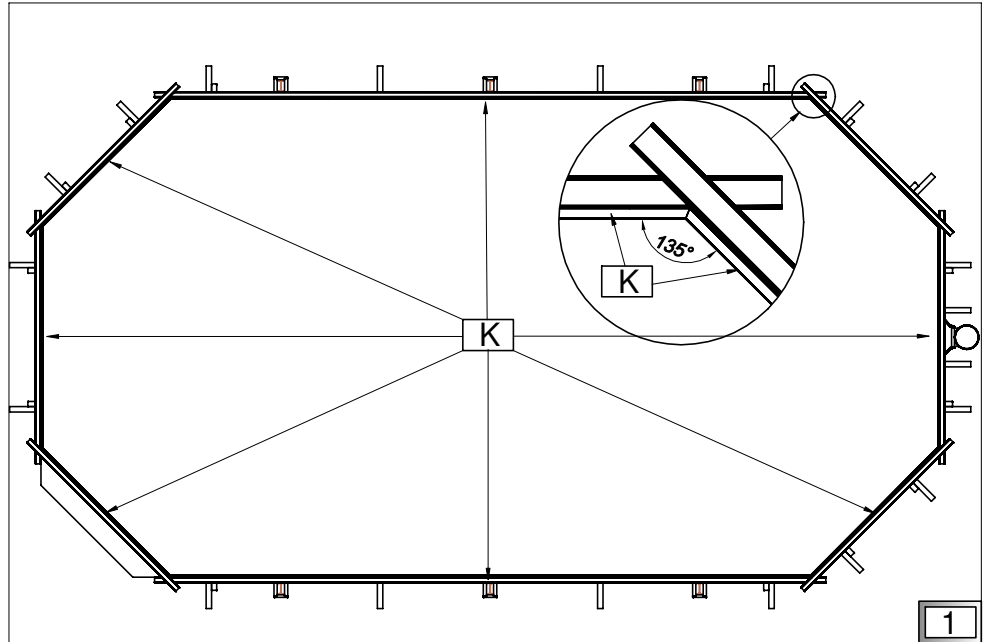
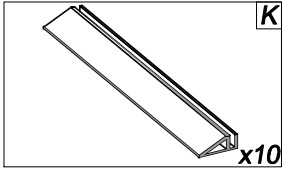

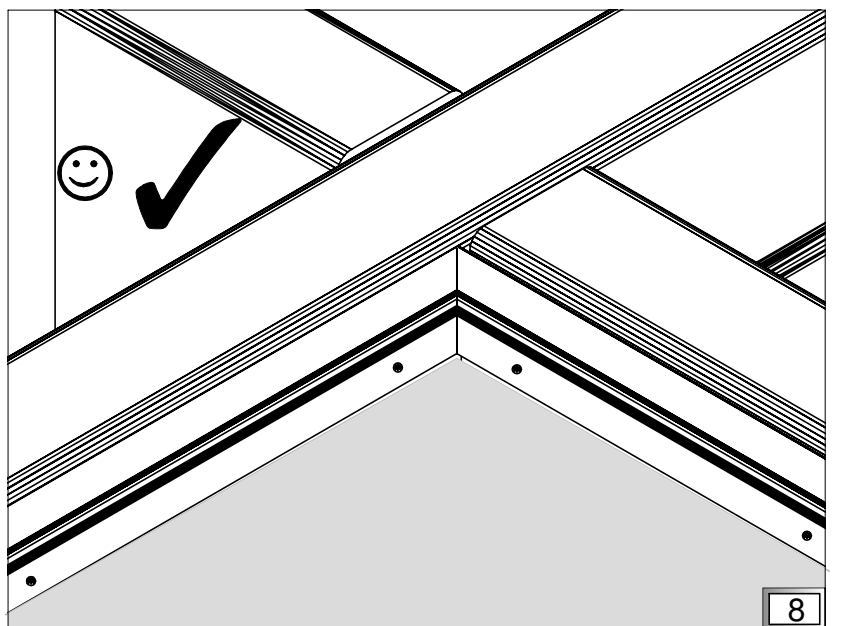
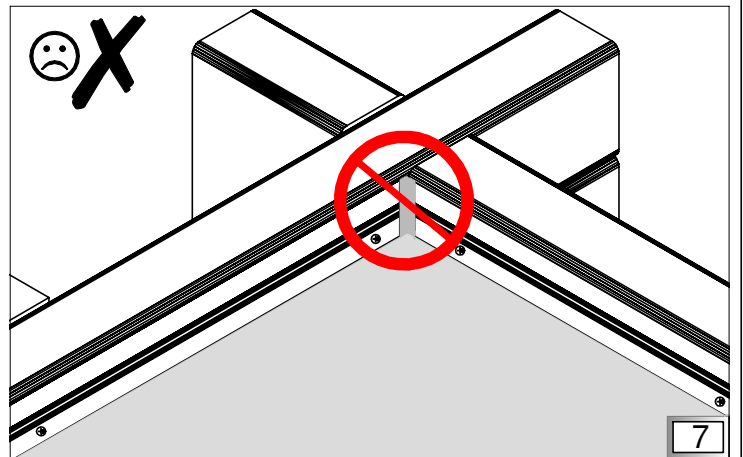
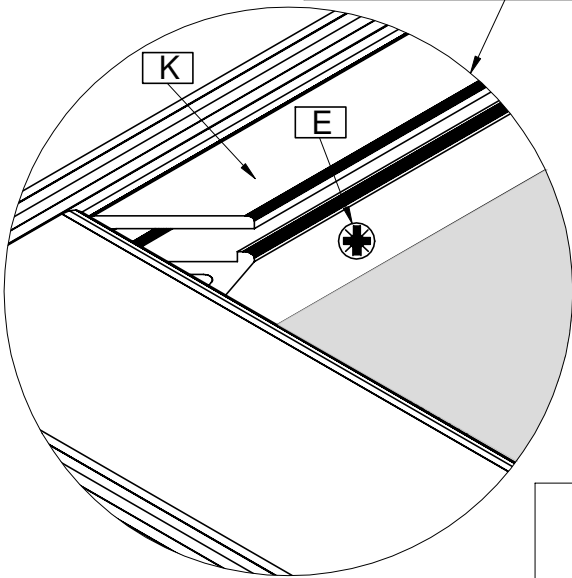
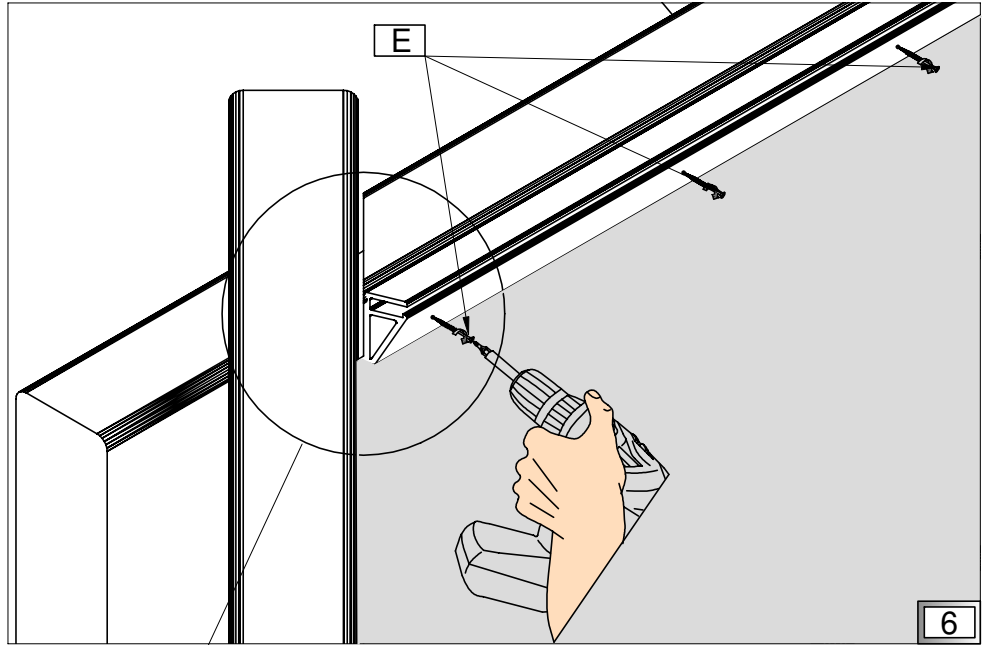
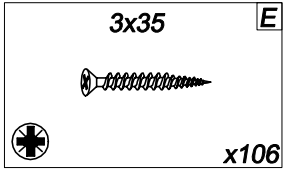

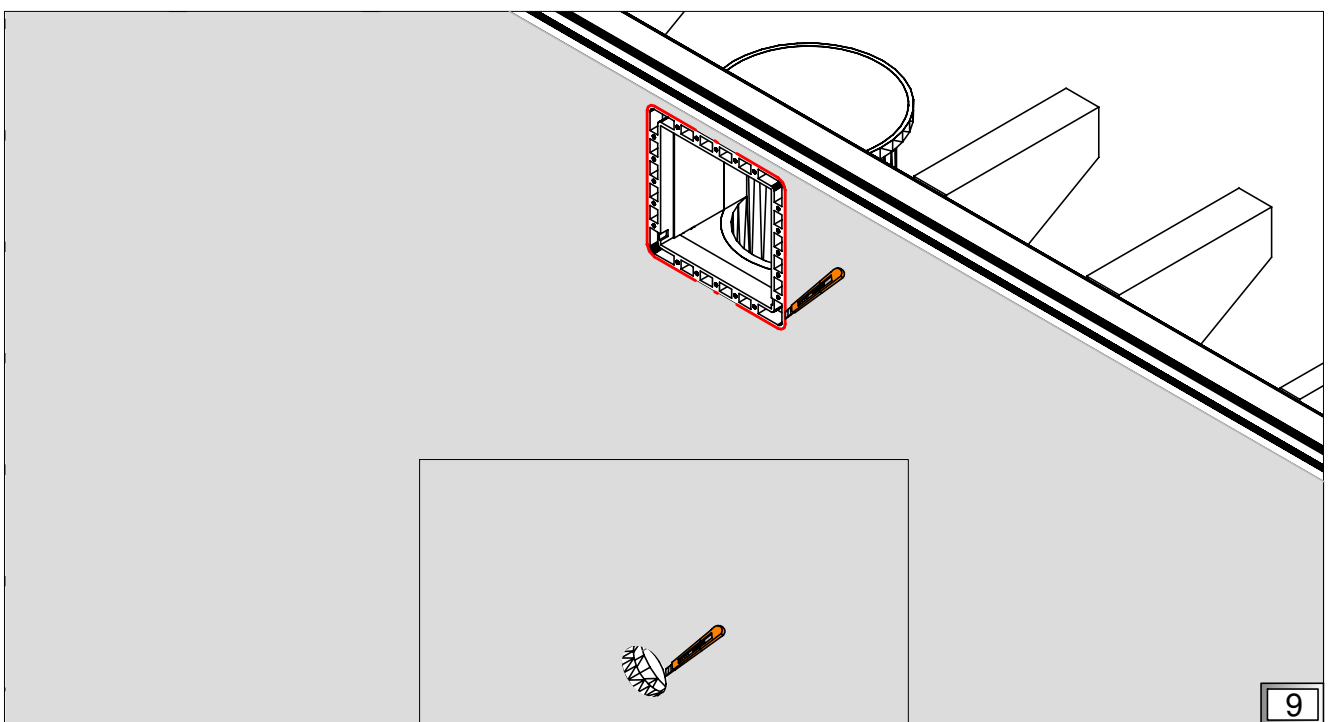
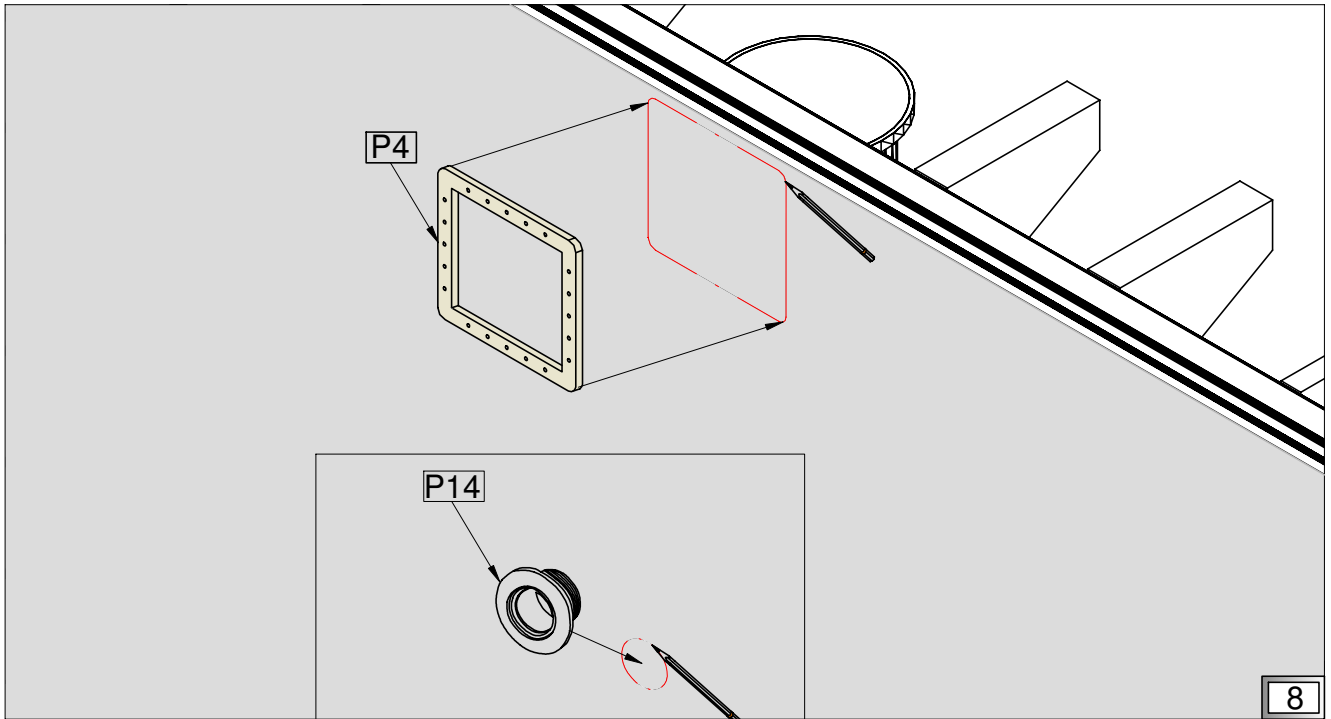
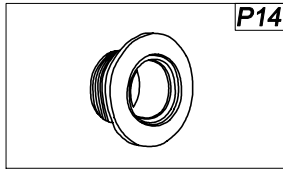
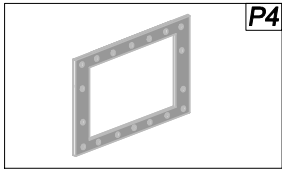

PL Geotextil

GB Geotextile

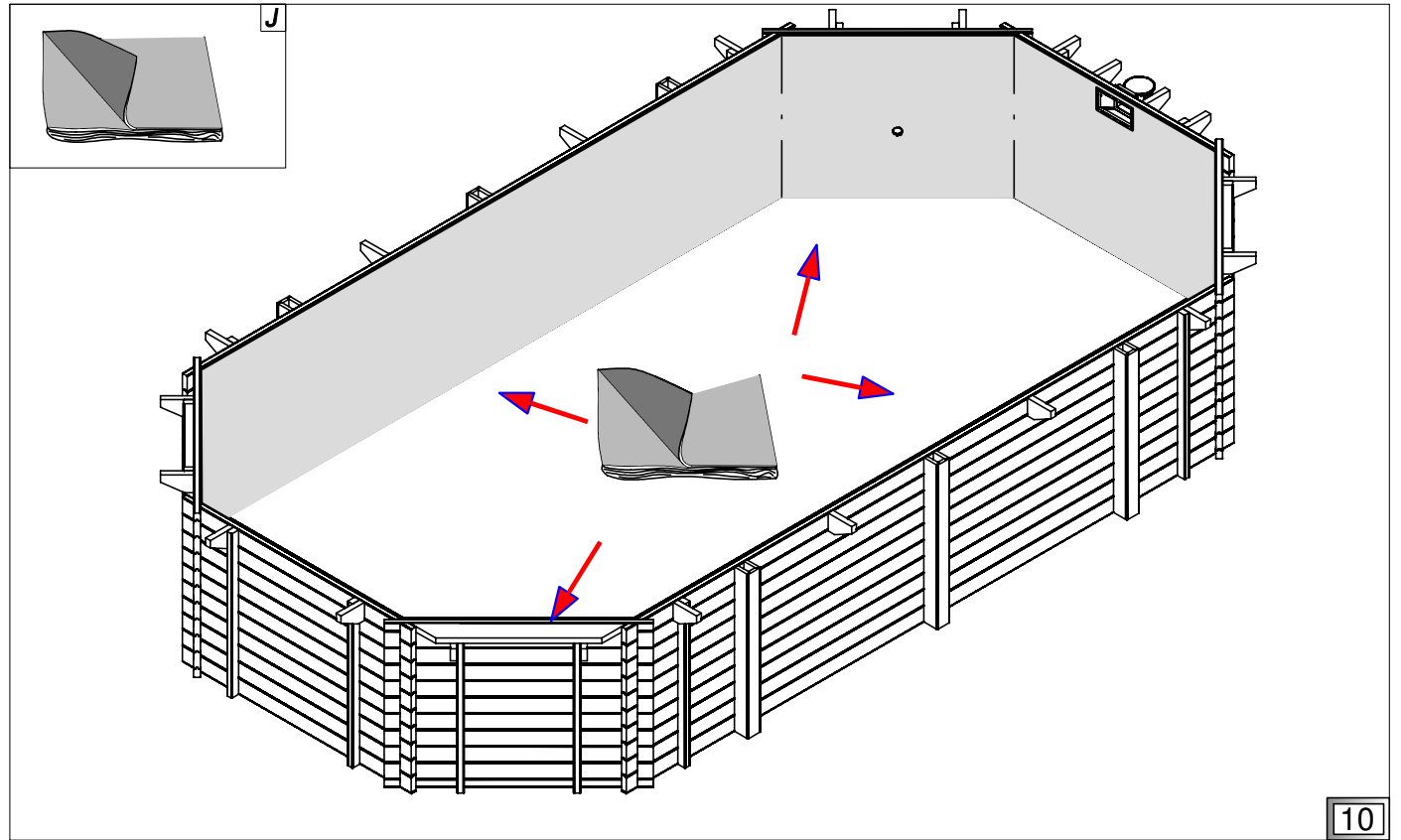

10

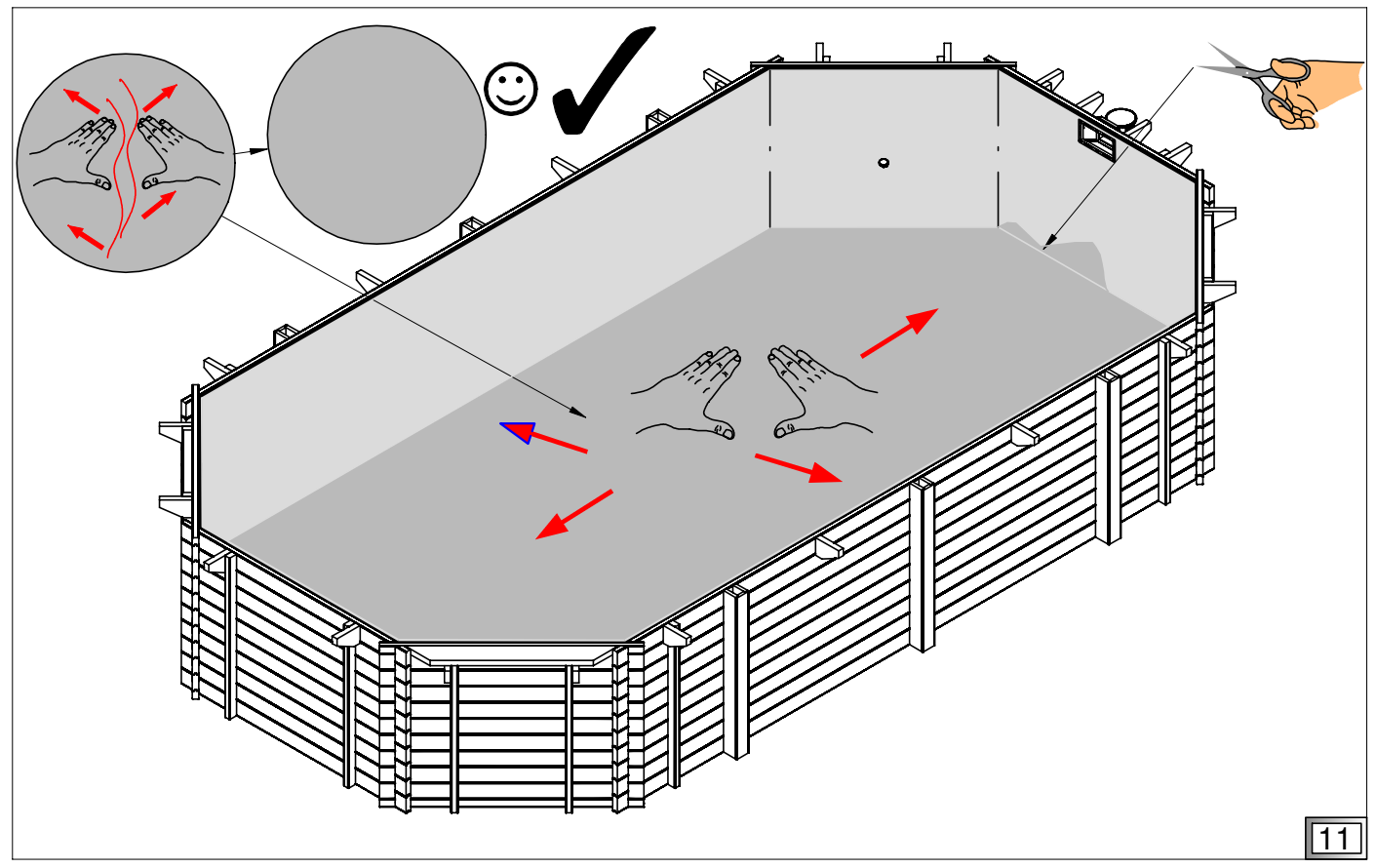

11

PL Liner

GB Liner

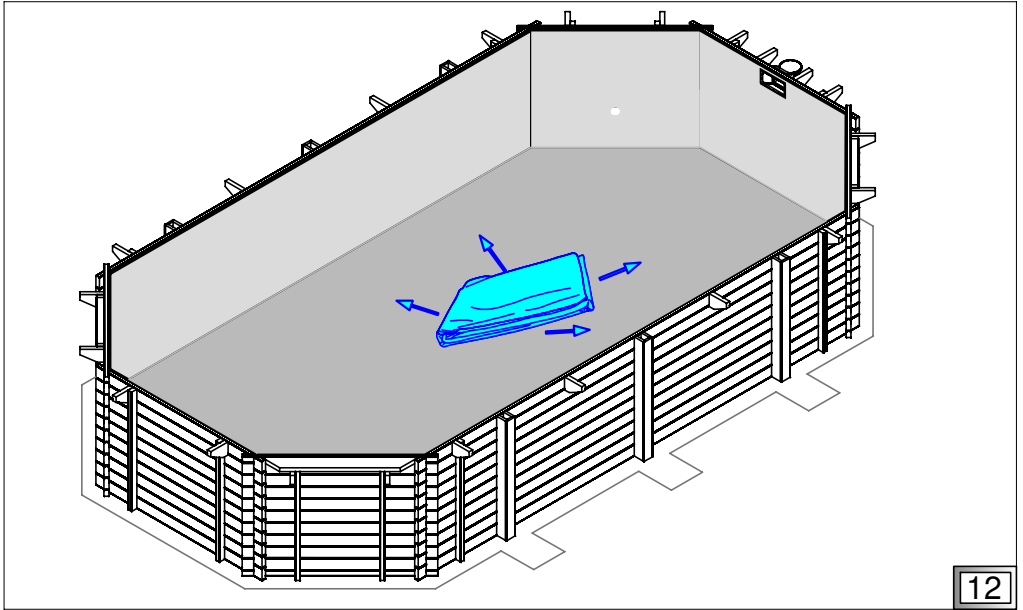
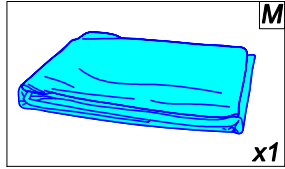
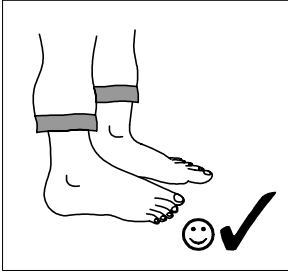
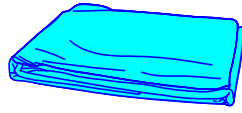

12

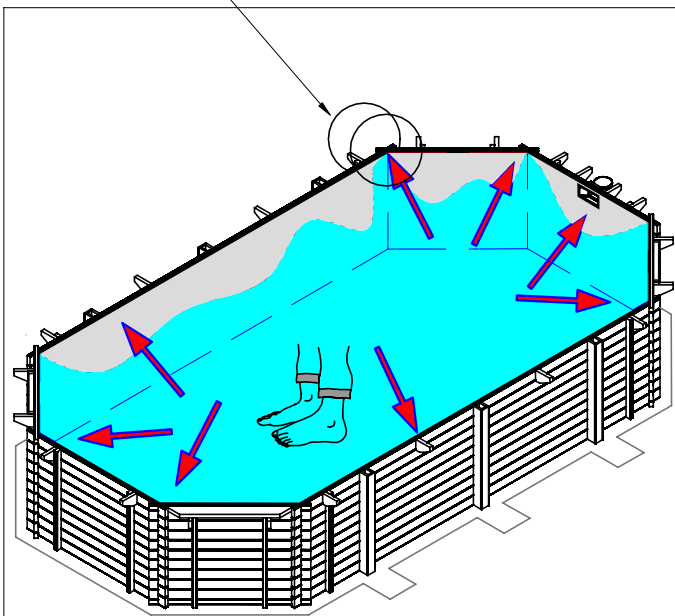
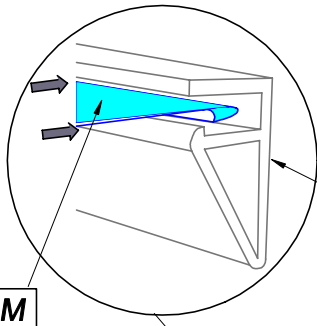

13

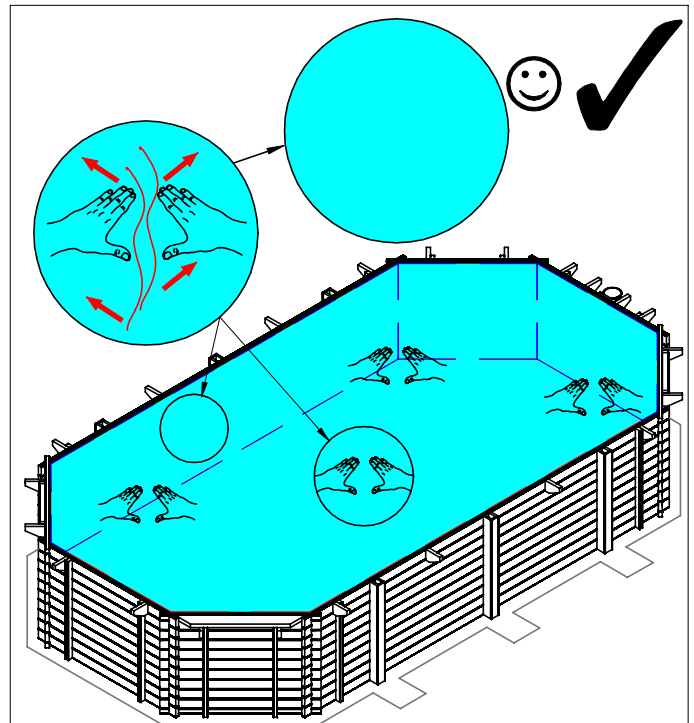

14

PL Liner

GB Liner

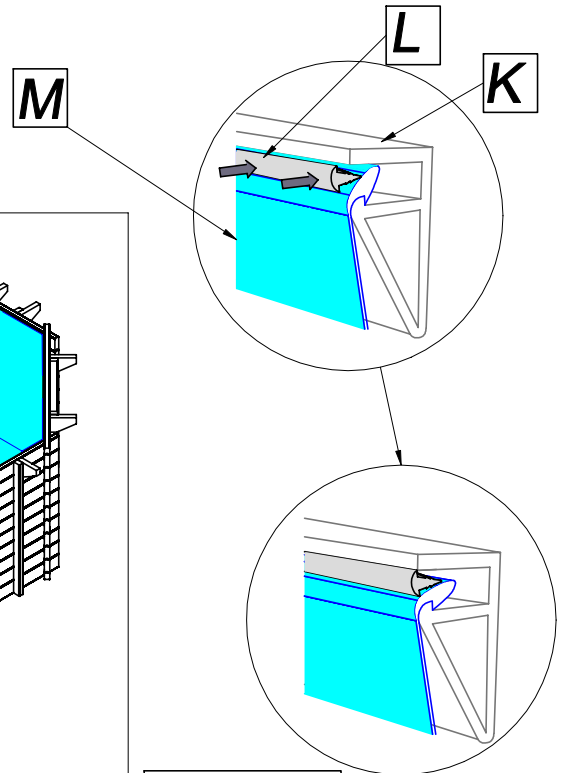
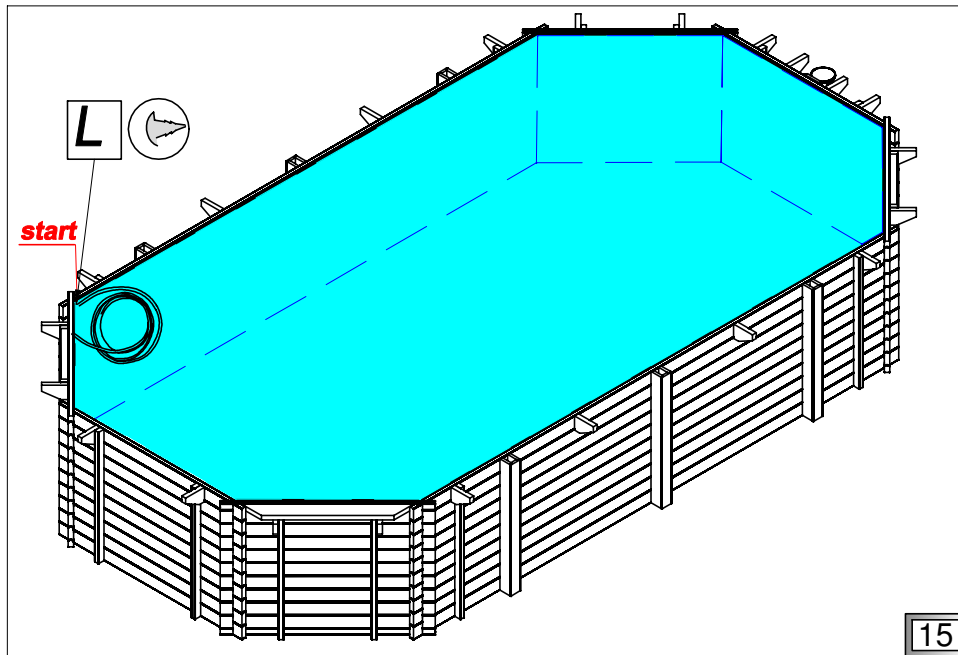
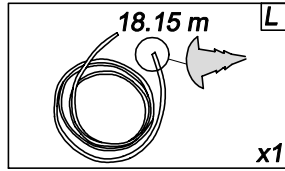
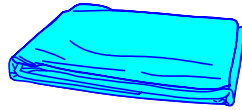

15

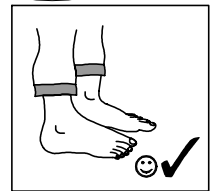

PL Wyrównaj sfaldowania po nalaniu wody.

GB Smooth all folds after pouring water.

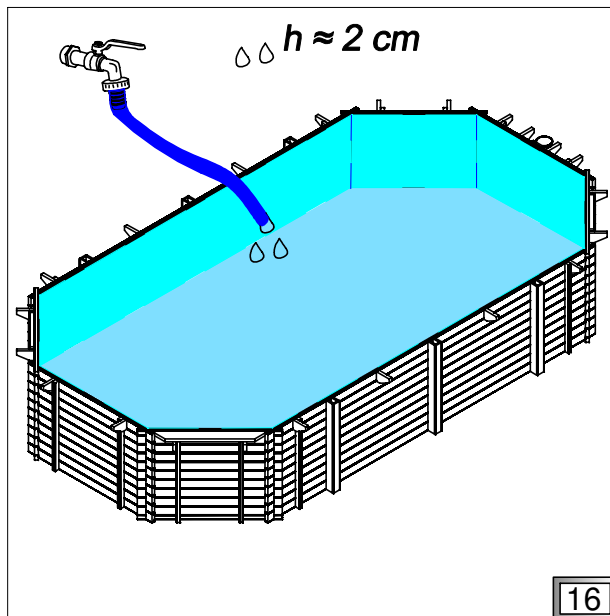

16

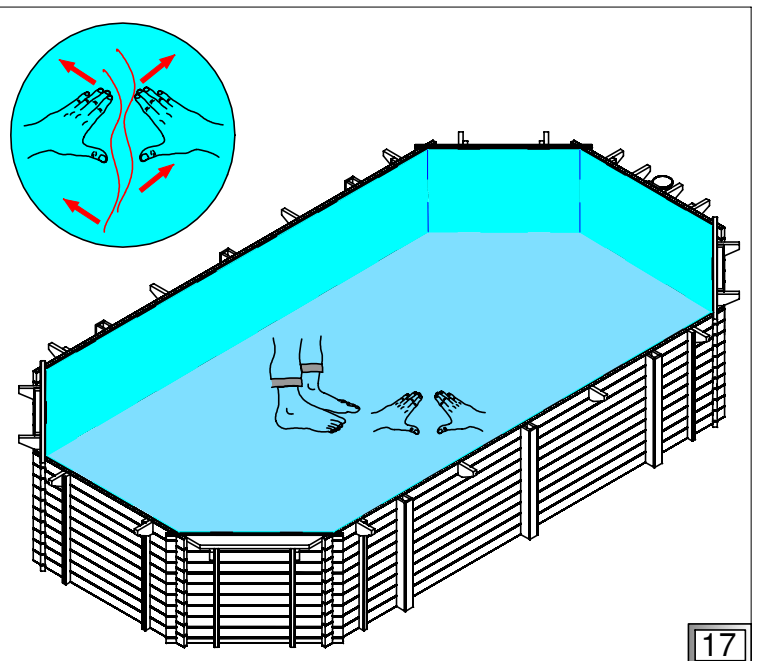

17

PL Dysze

GB Nozzles

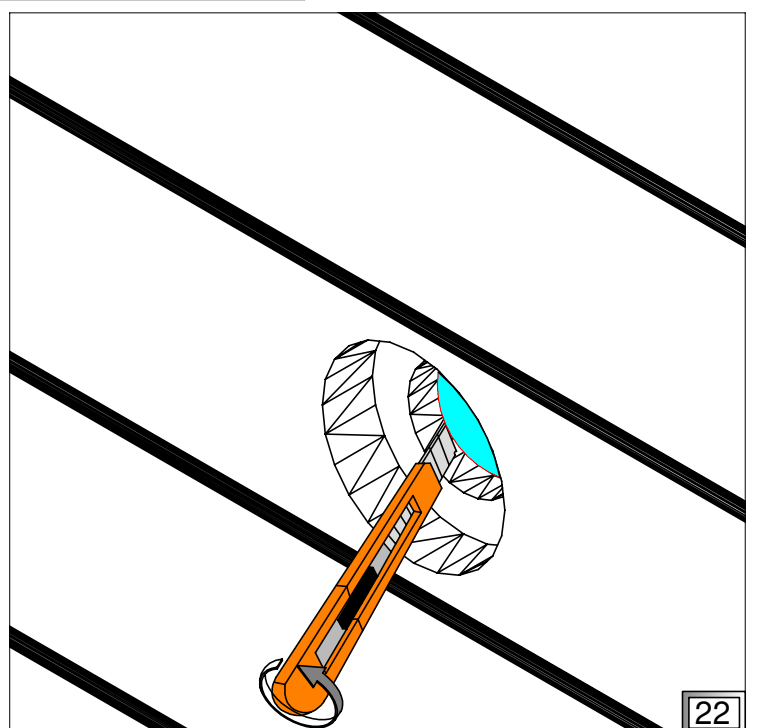
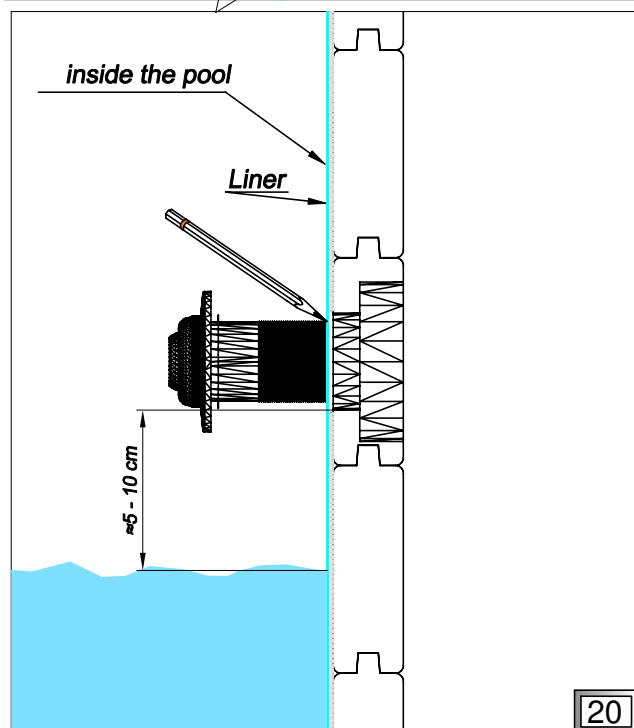
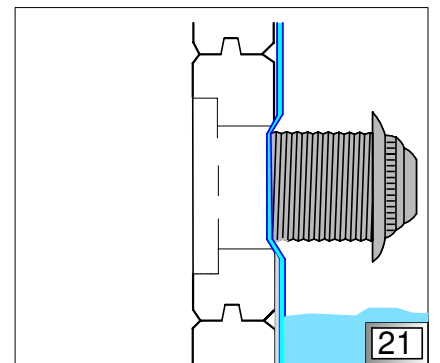
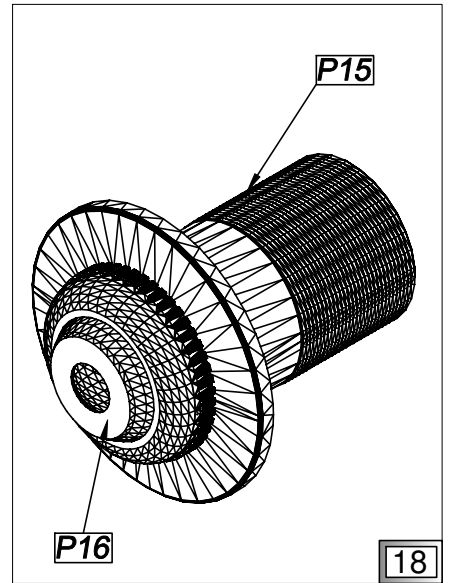
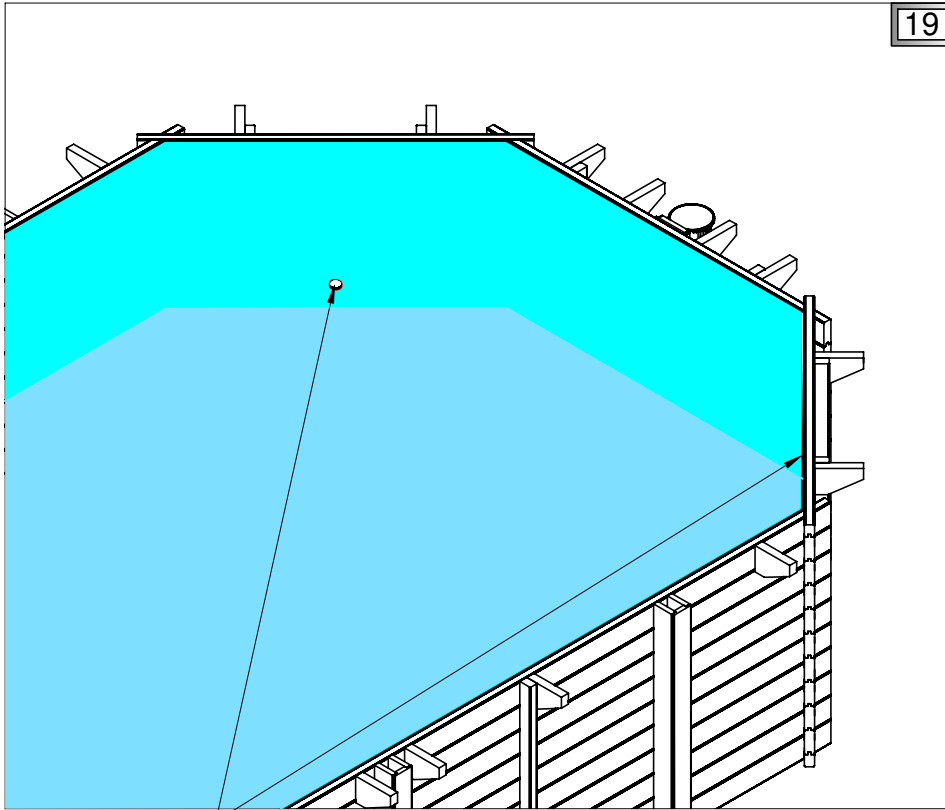
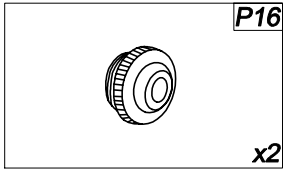
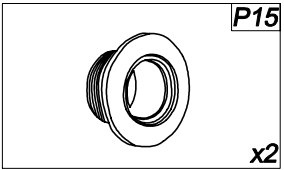

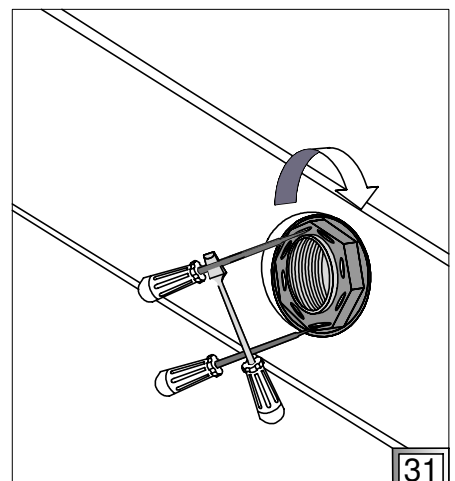
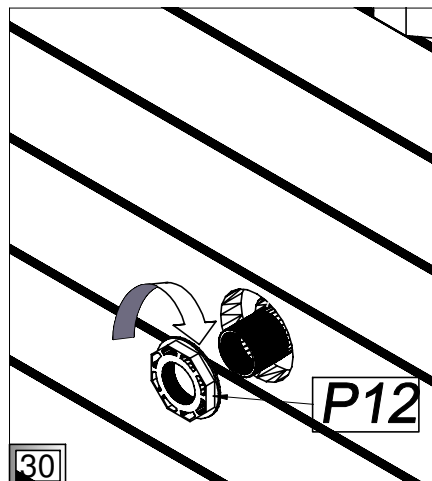
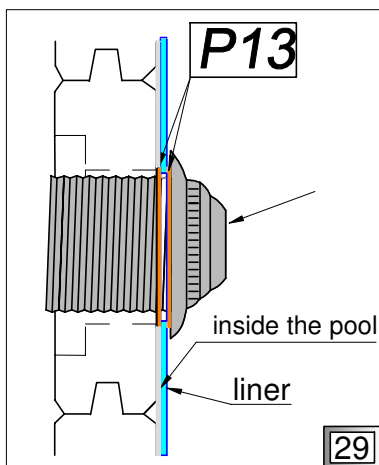
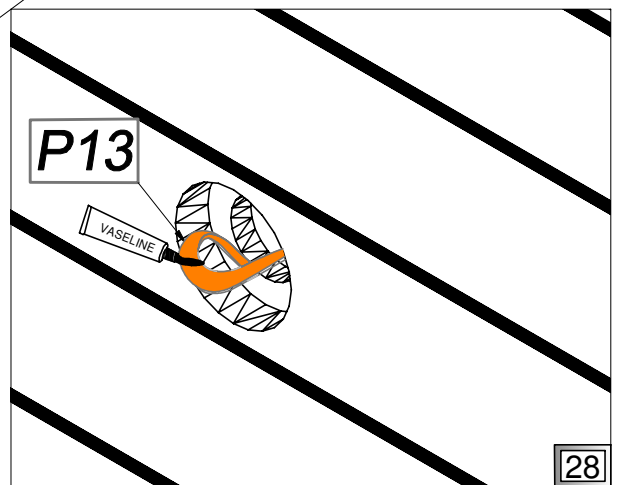
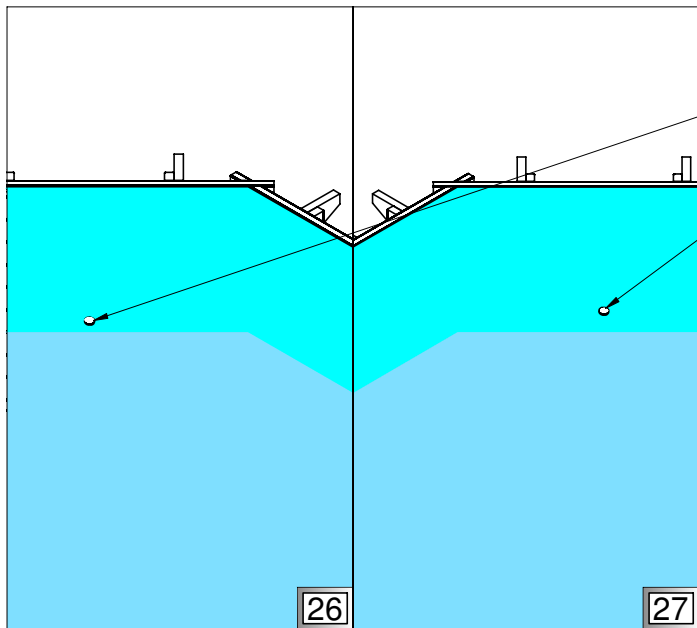
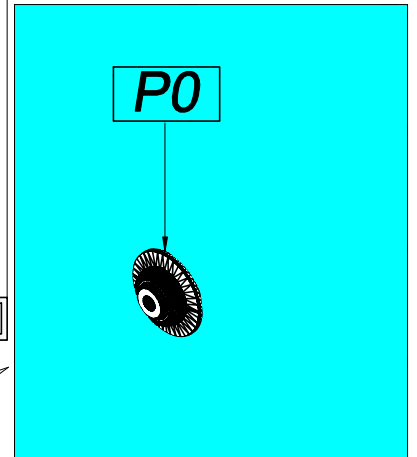
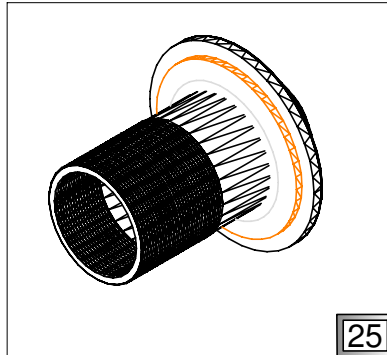
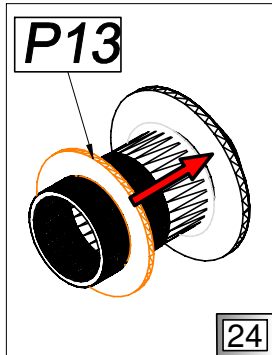
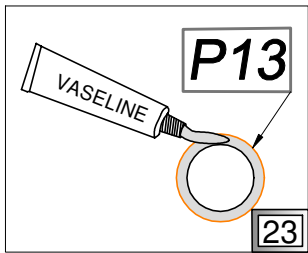
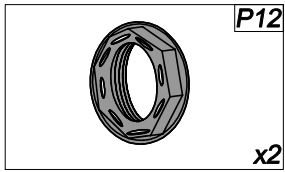
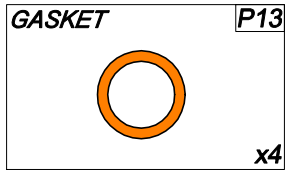

PL *Dysze*

GB *Nozzles*

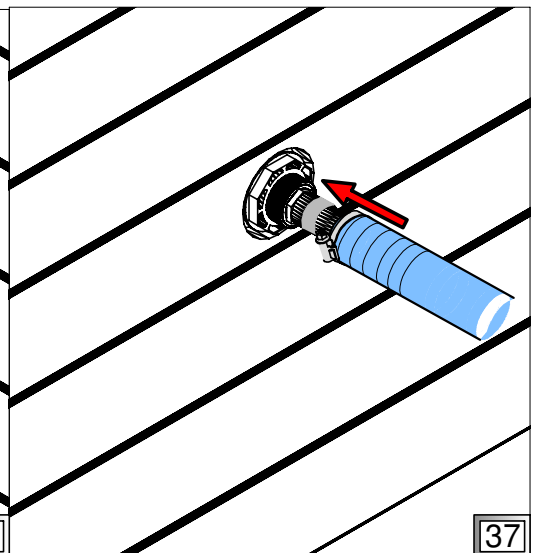
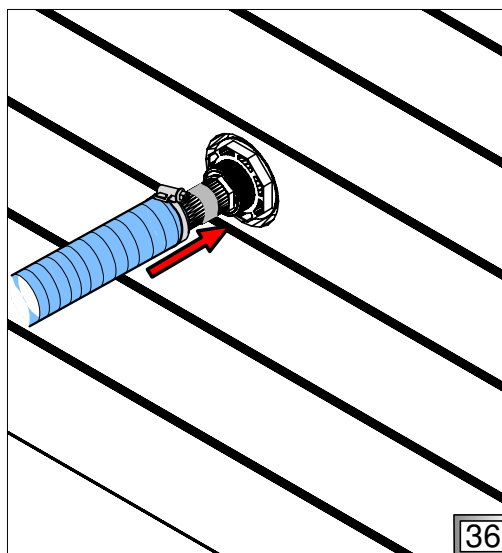
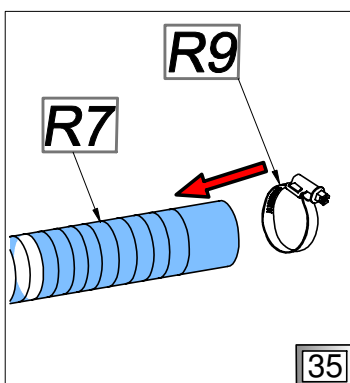
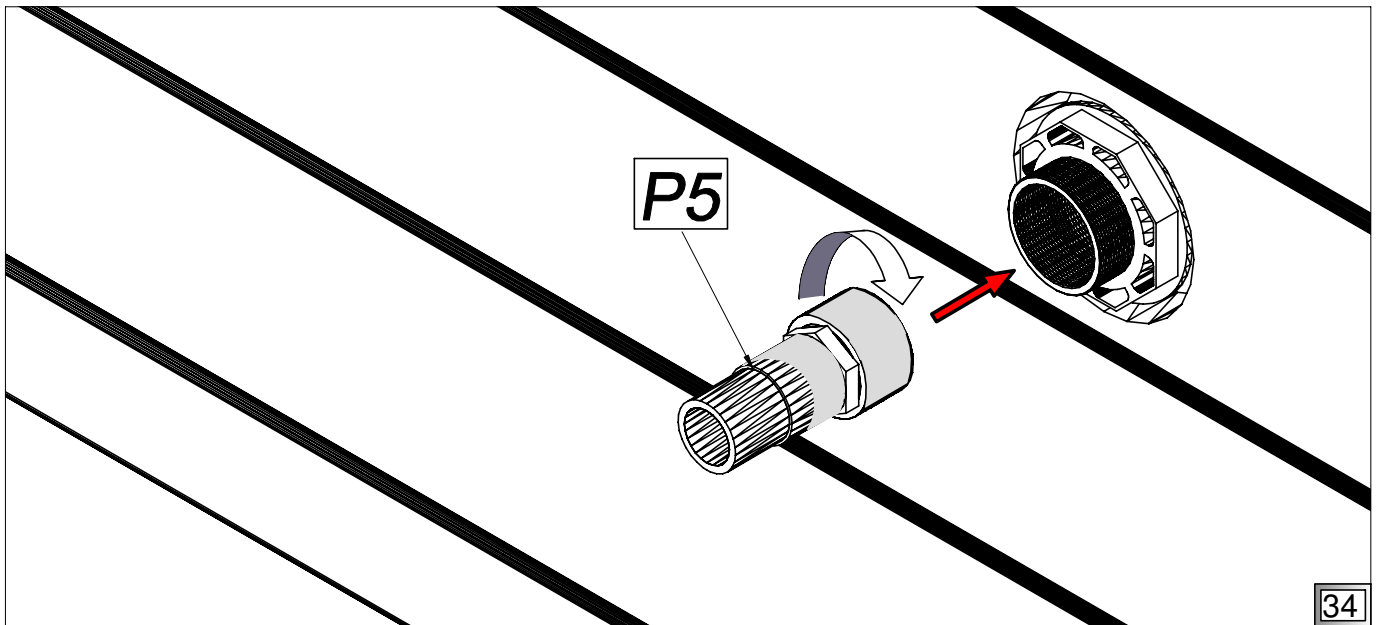
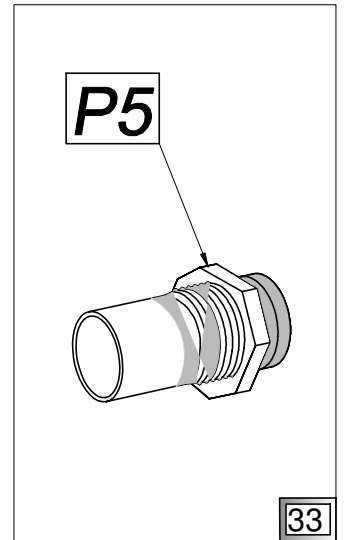
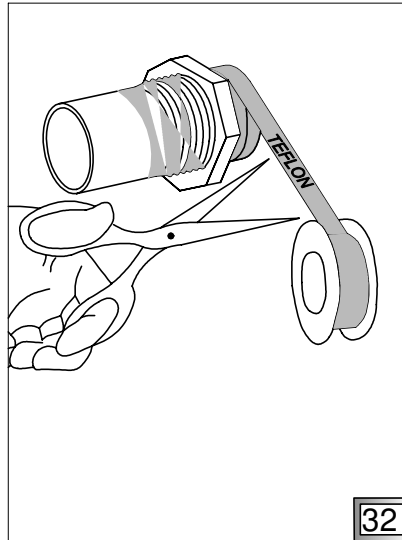
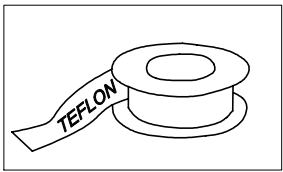
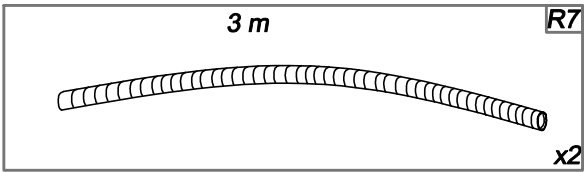
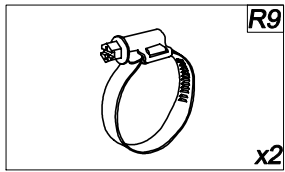
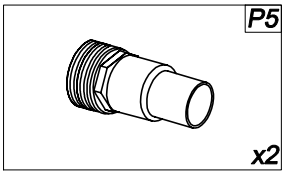

PL *Dysze*

GB *Nozzles*

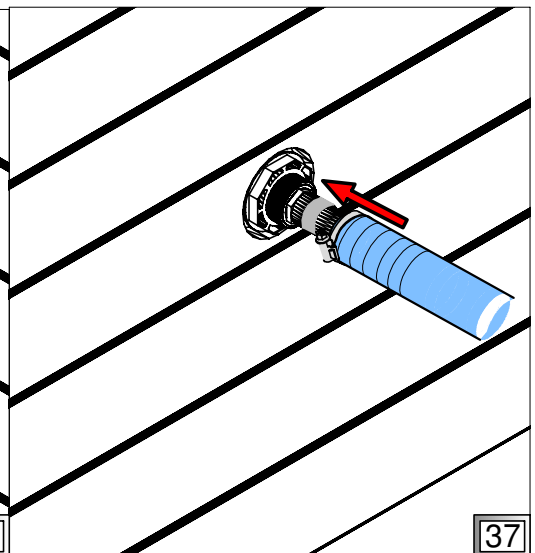
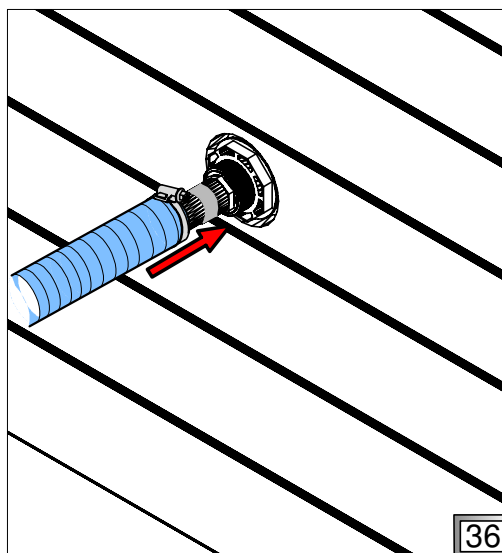
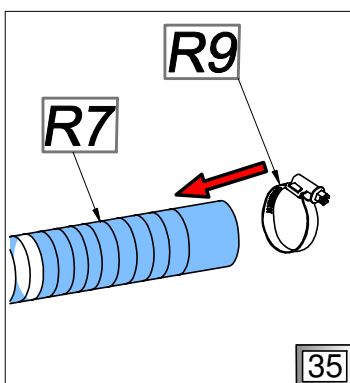
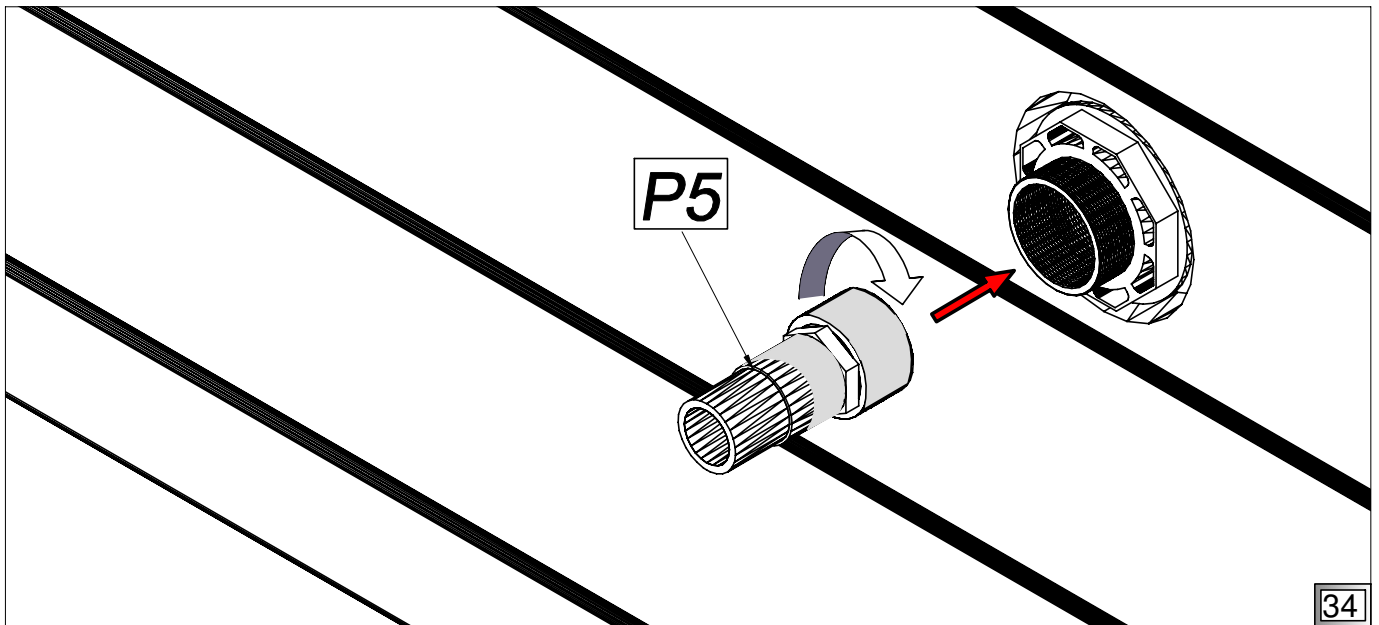
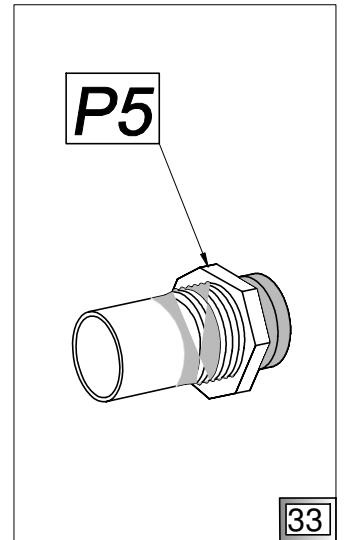
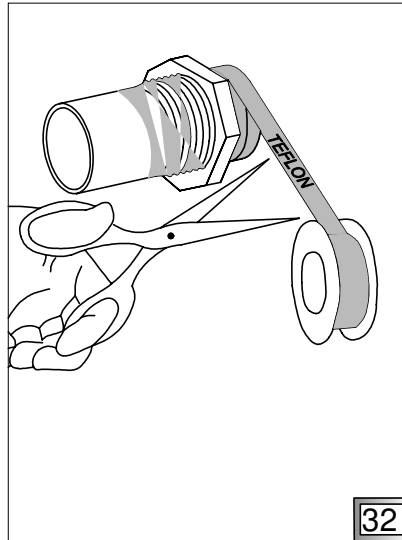
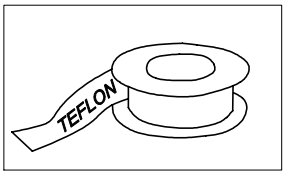
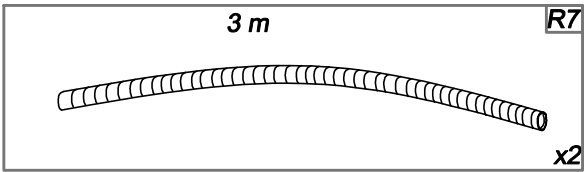
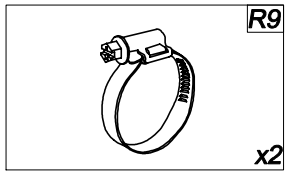
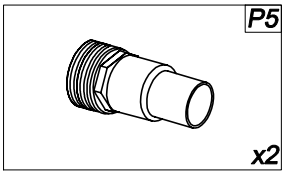

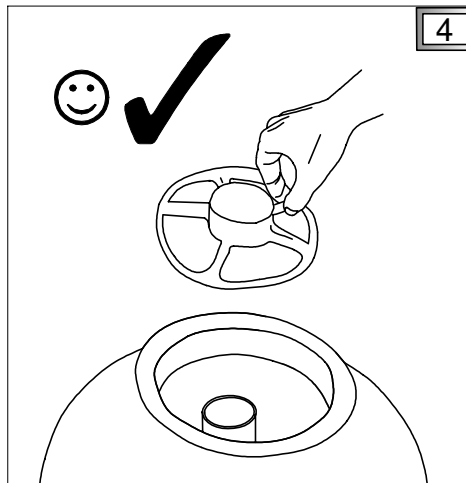
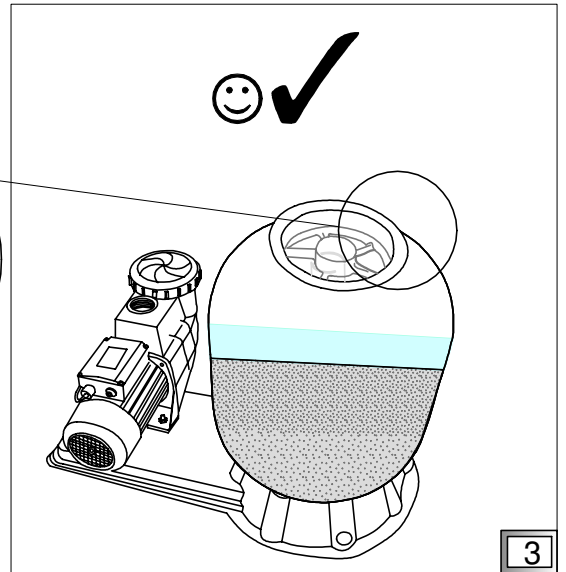
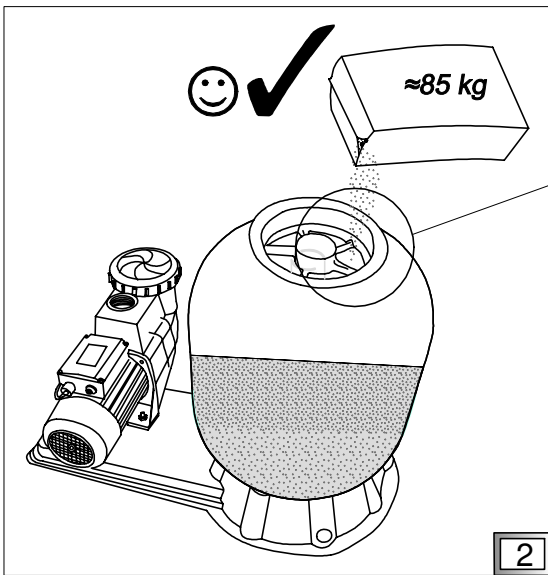
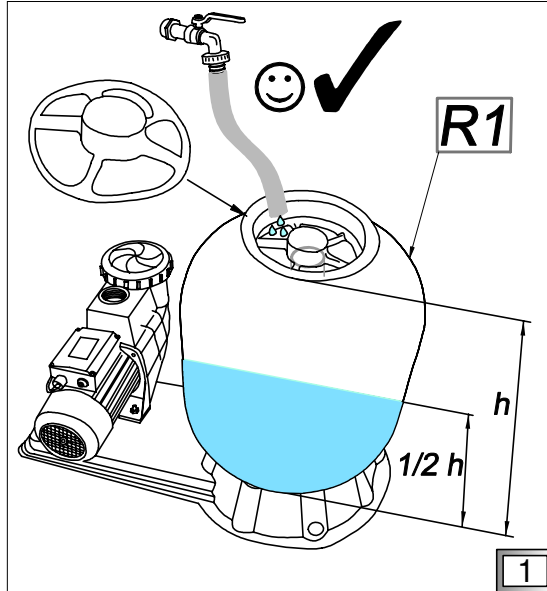
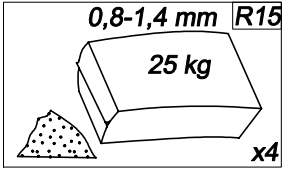

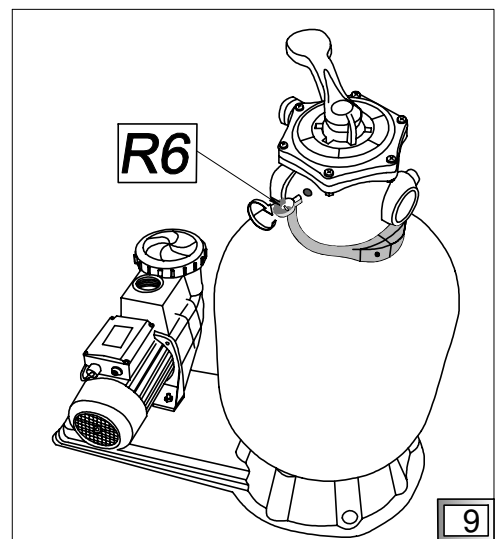
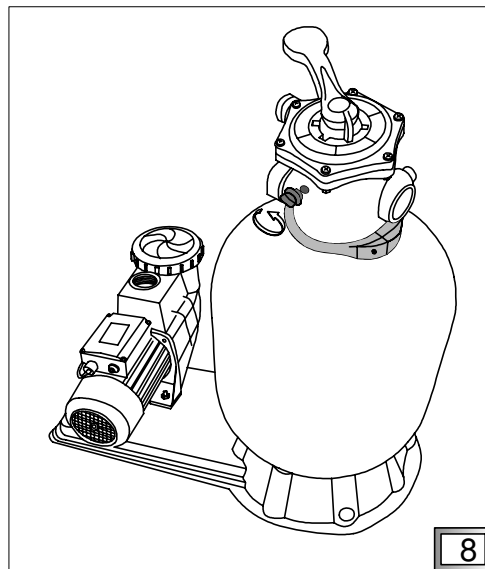
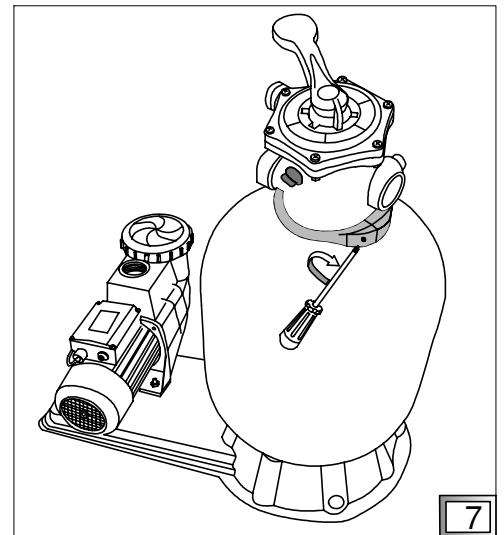
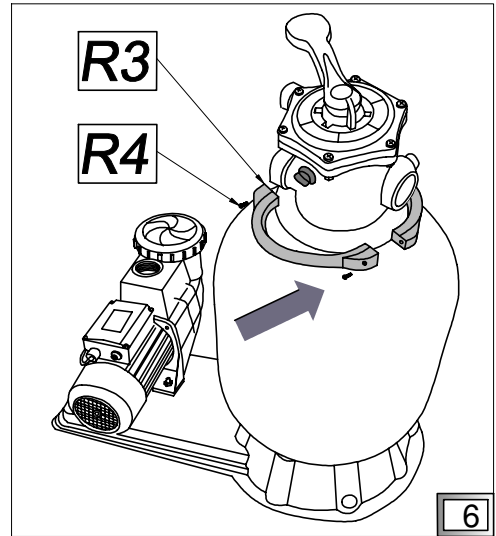
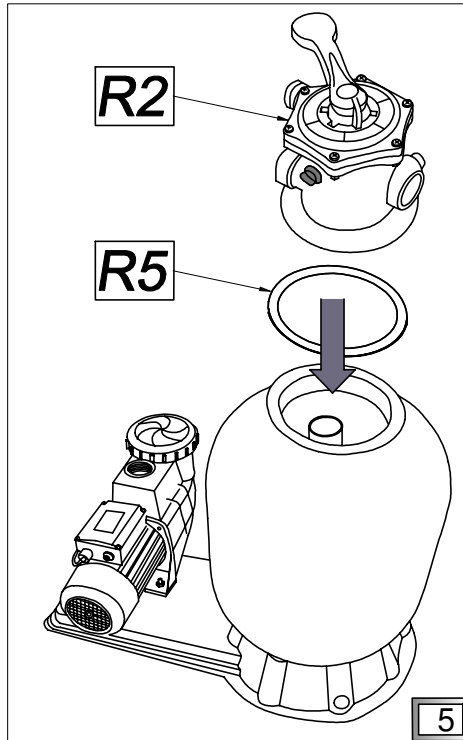
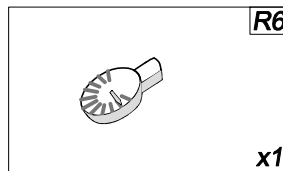
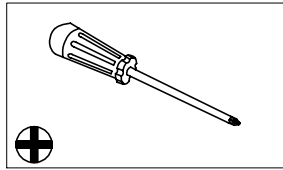
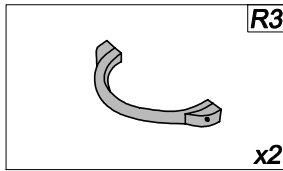
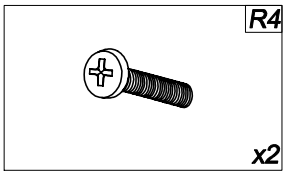
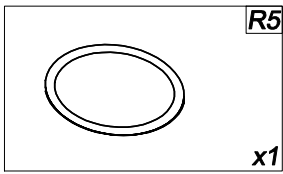
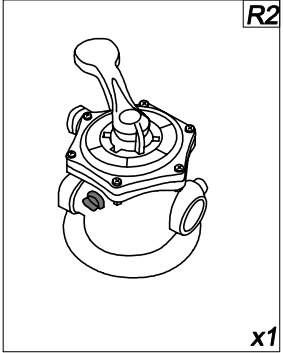

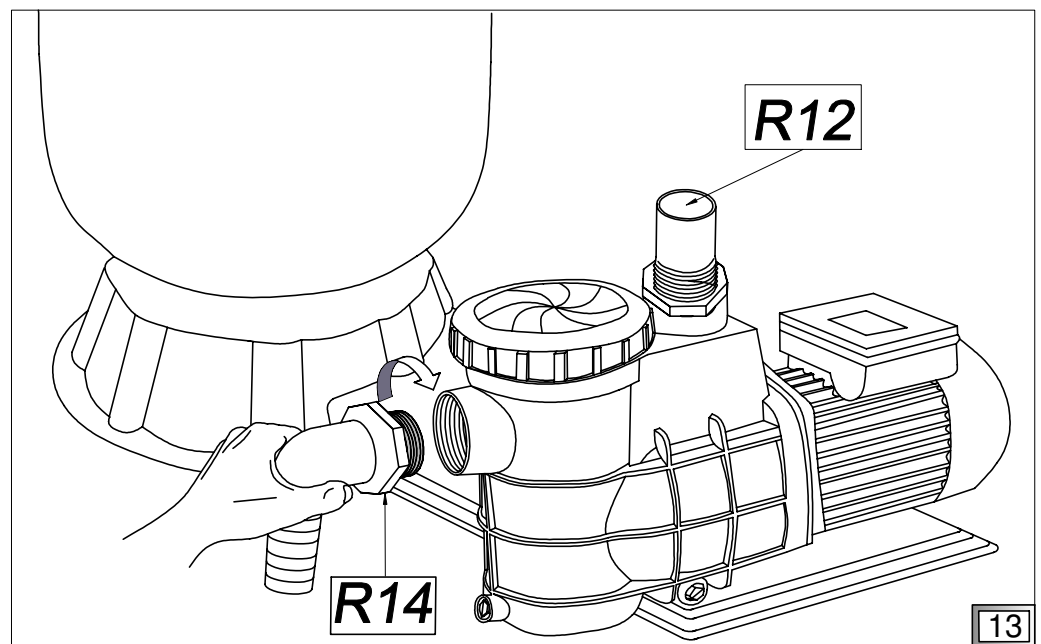
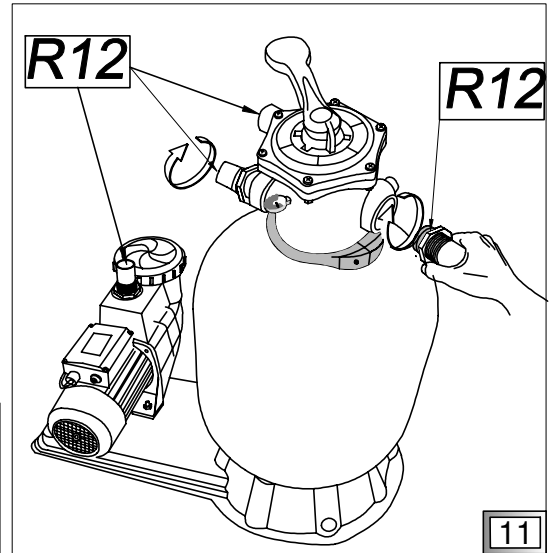
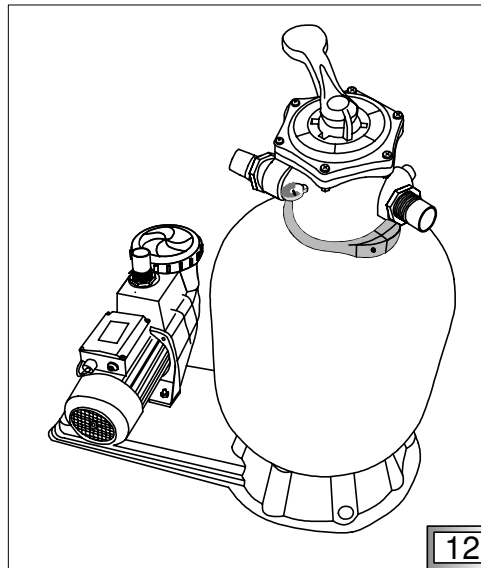
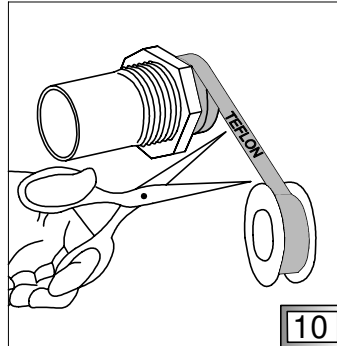
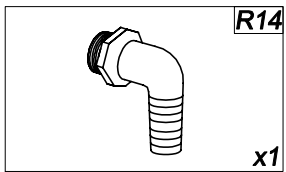
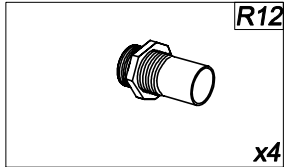

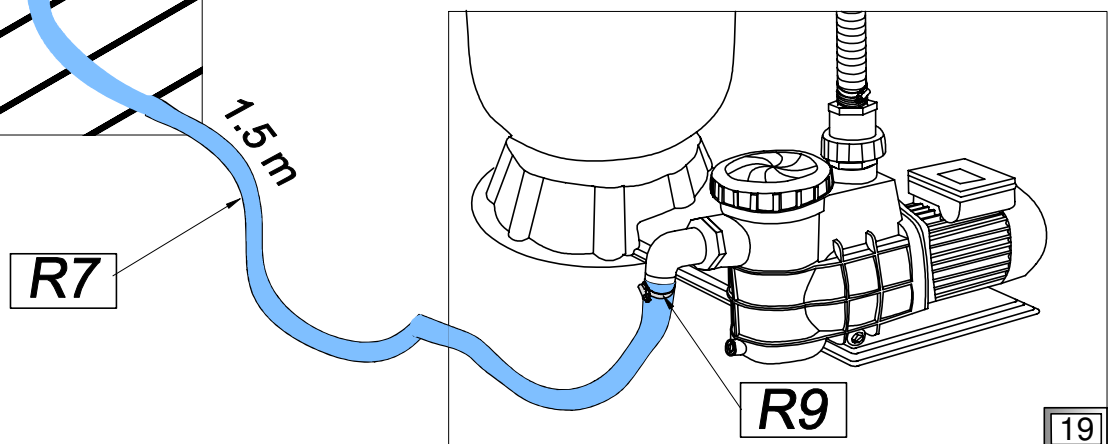
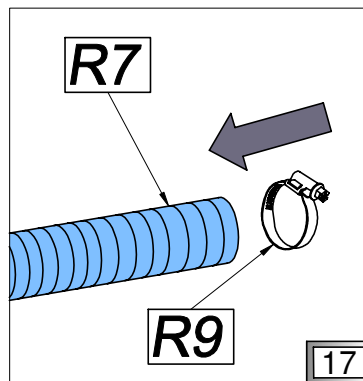
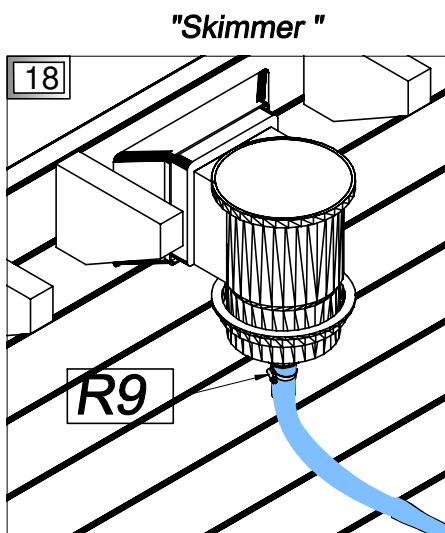
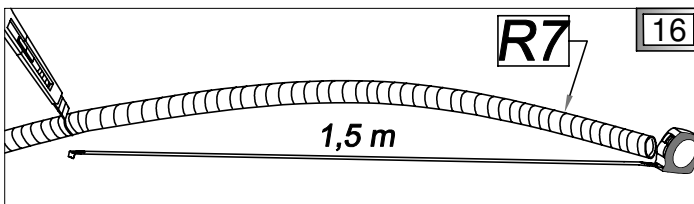
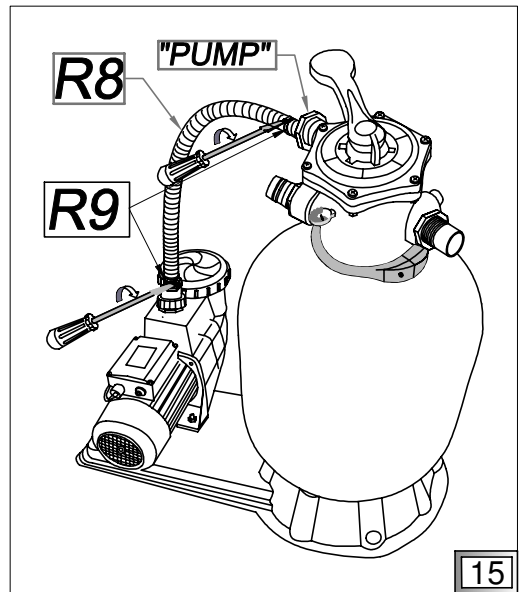
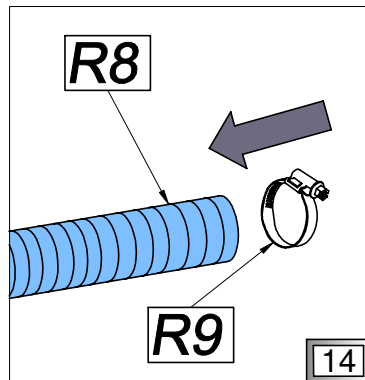
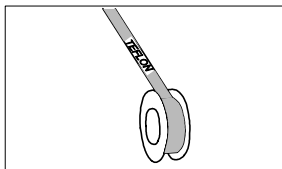
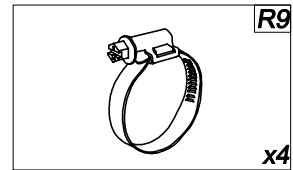
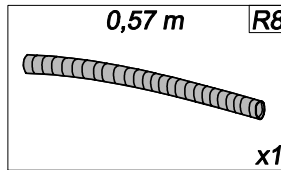
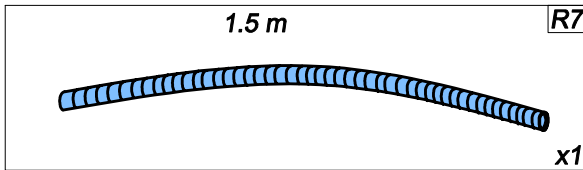

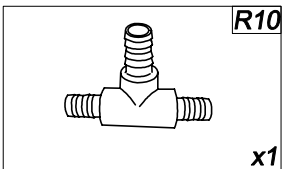
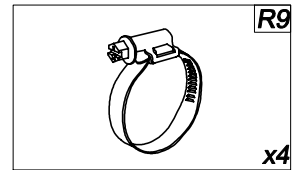
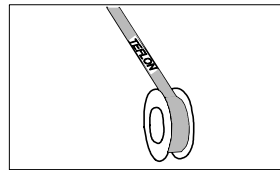
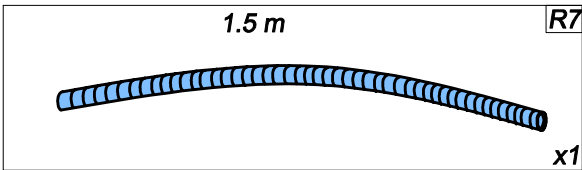

"Nozzle 2"

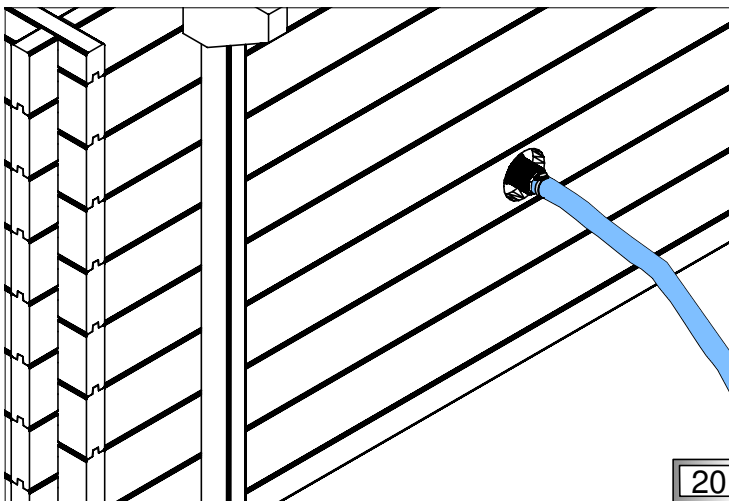

"Nozzle 1"

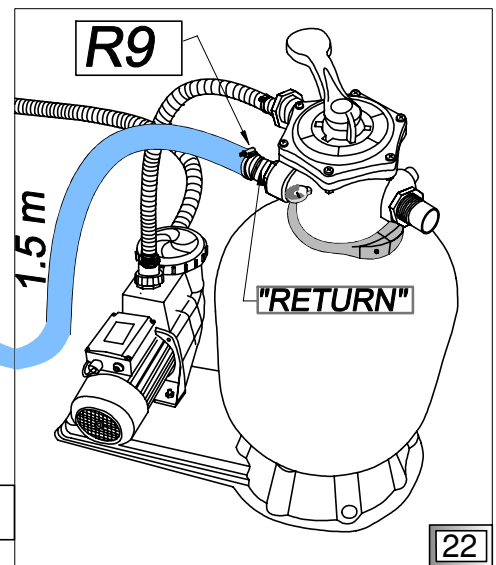
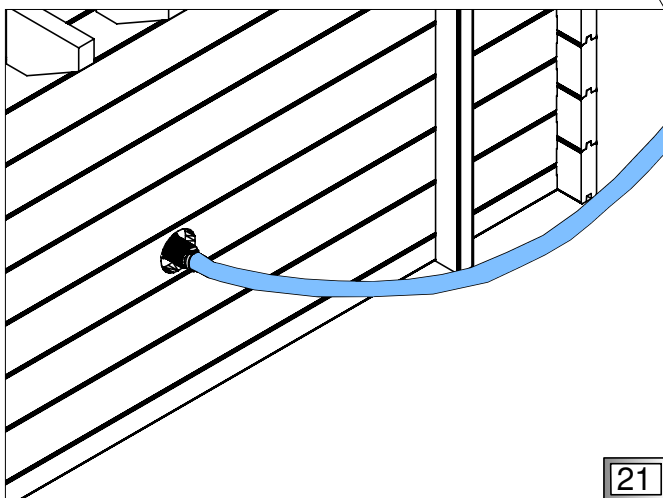

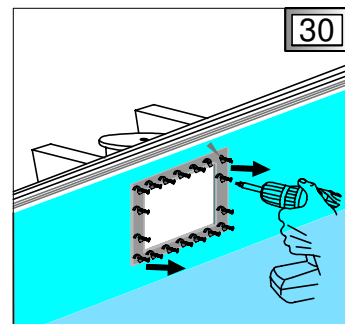
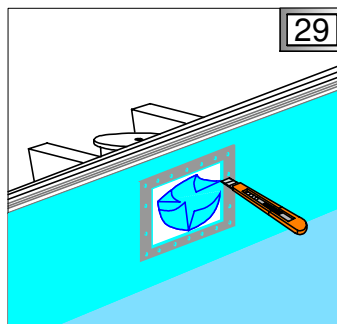
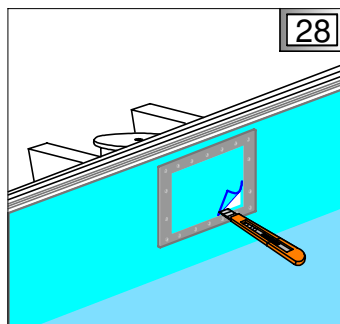
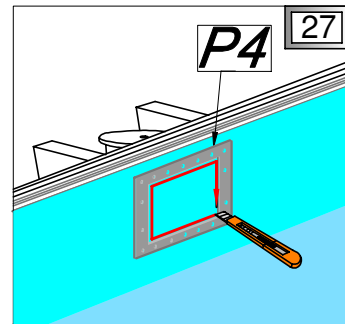
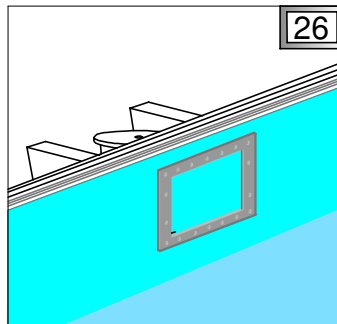
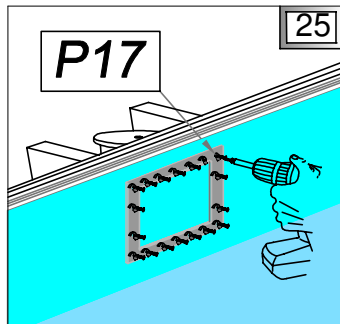
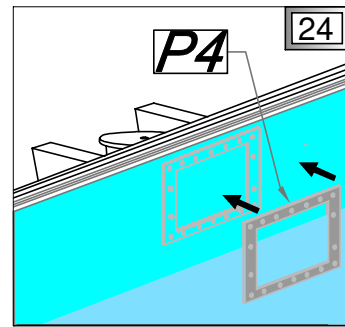
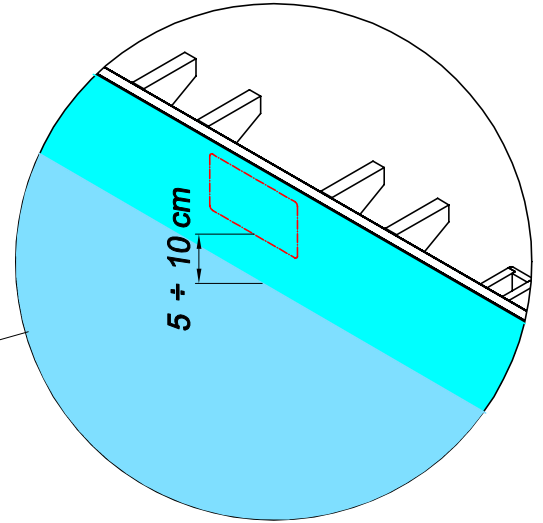
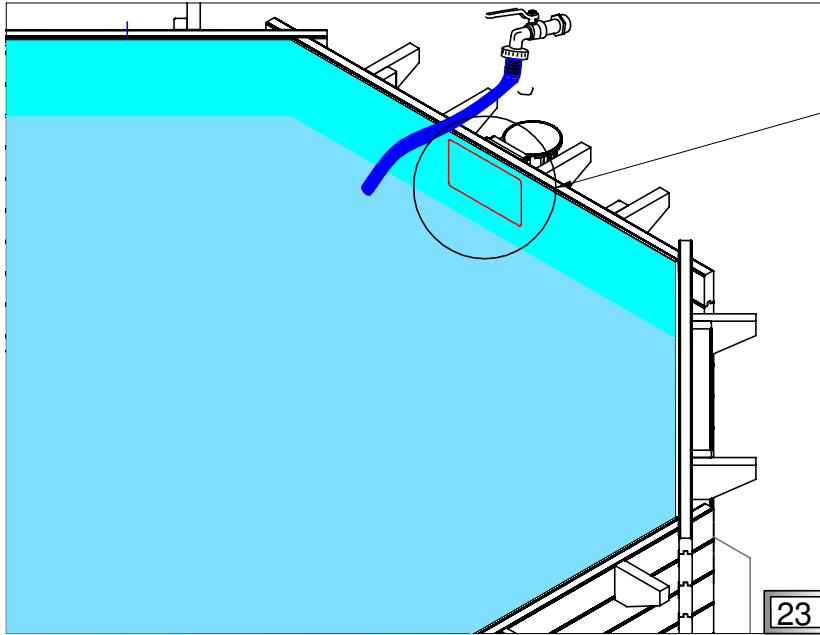
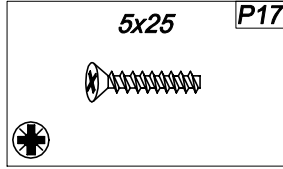
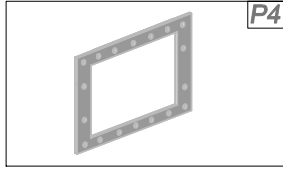

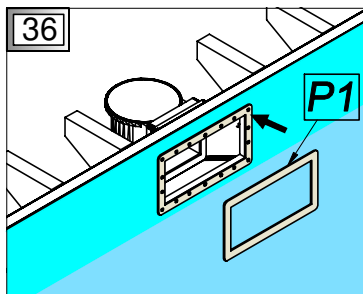
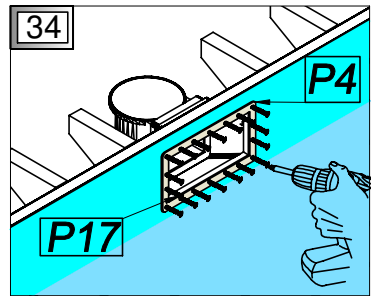
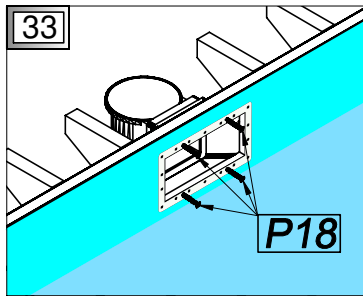
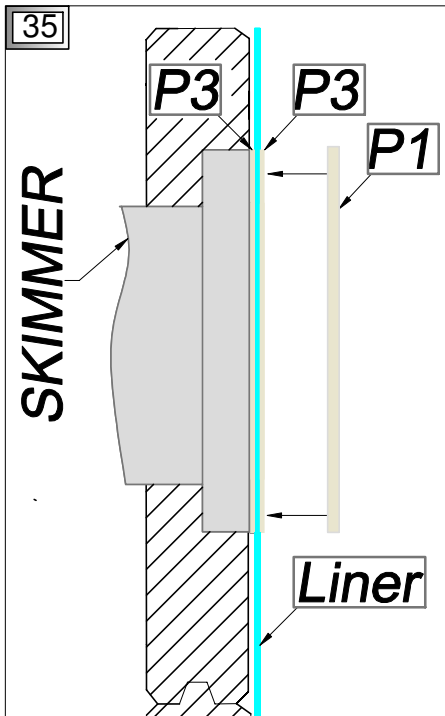
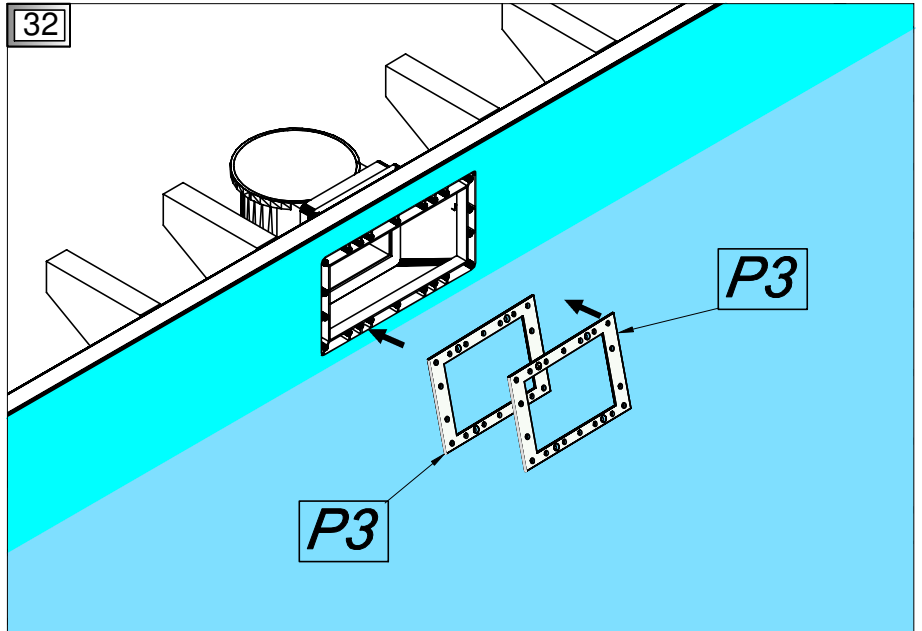
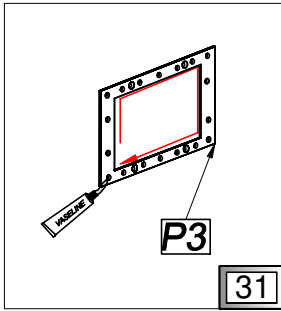
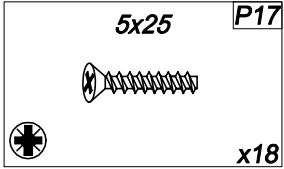
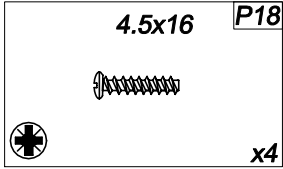
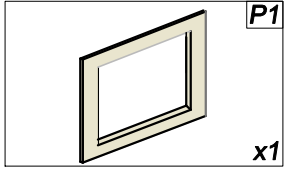
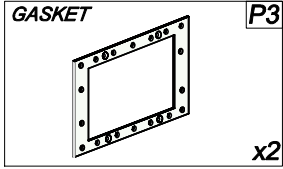
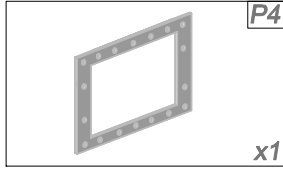

PL *Napełnianie wodą*

GB *Filling water*

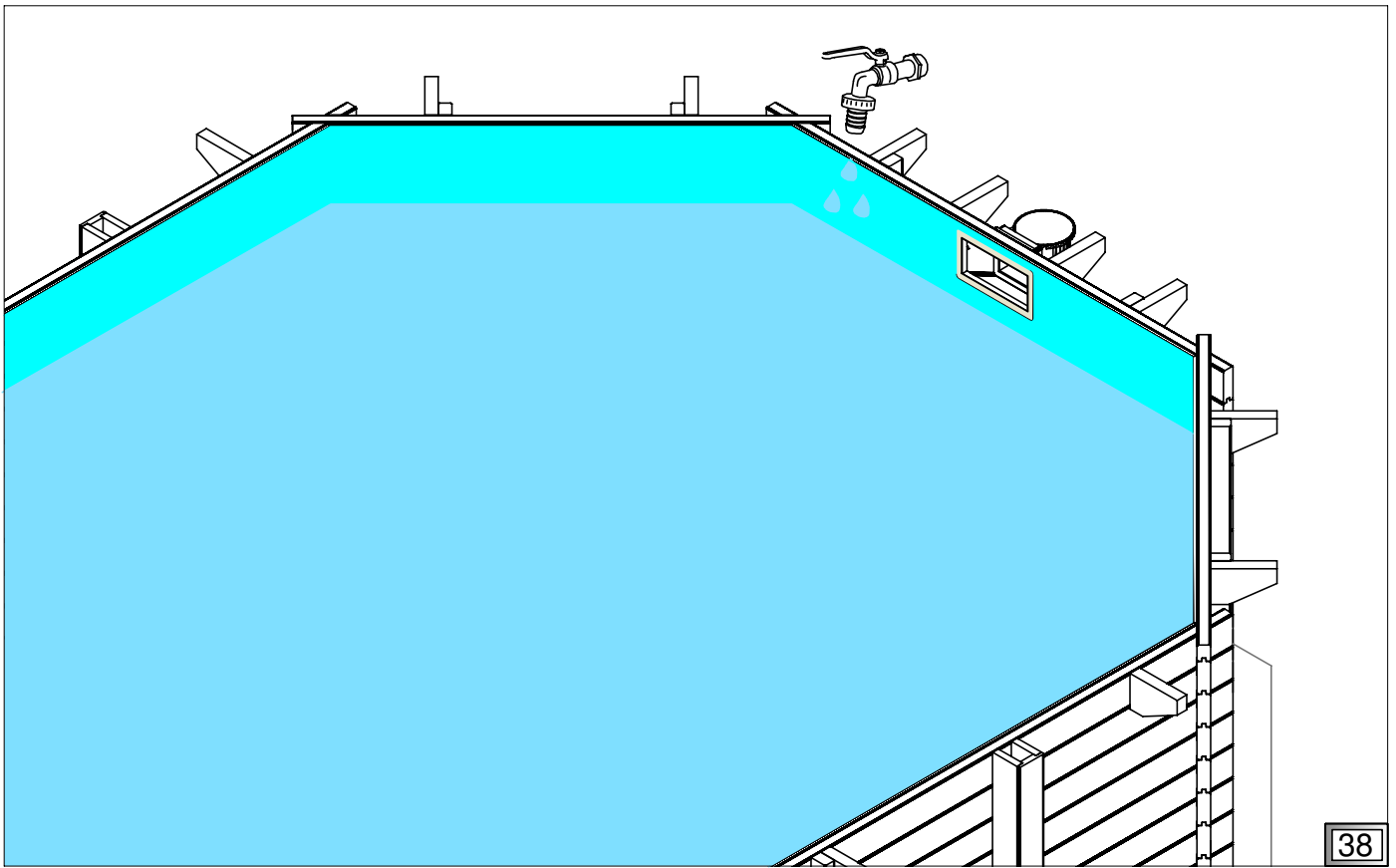

38

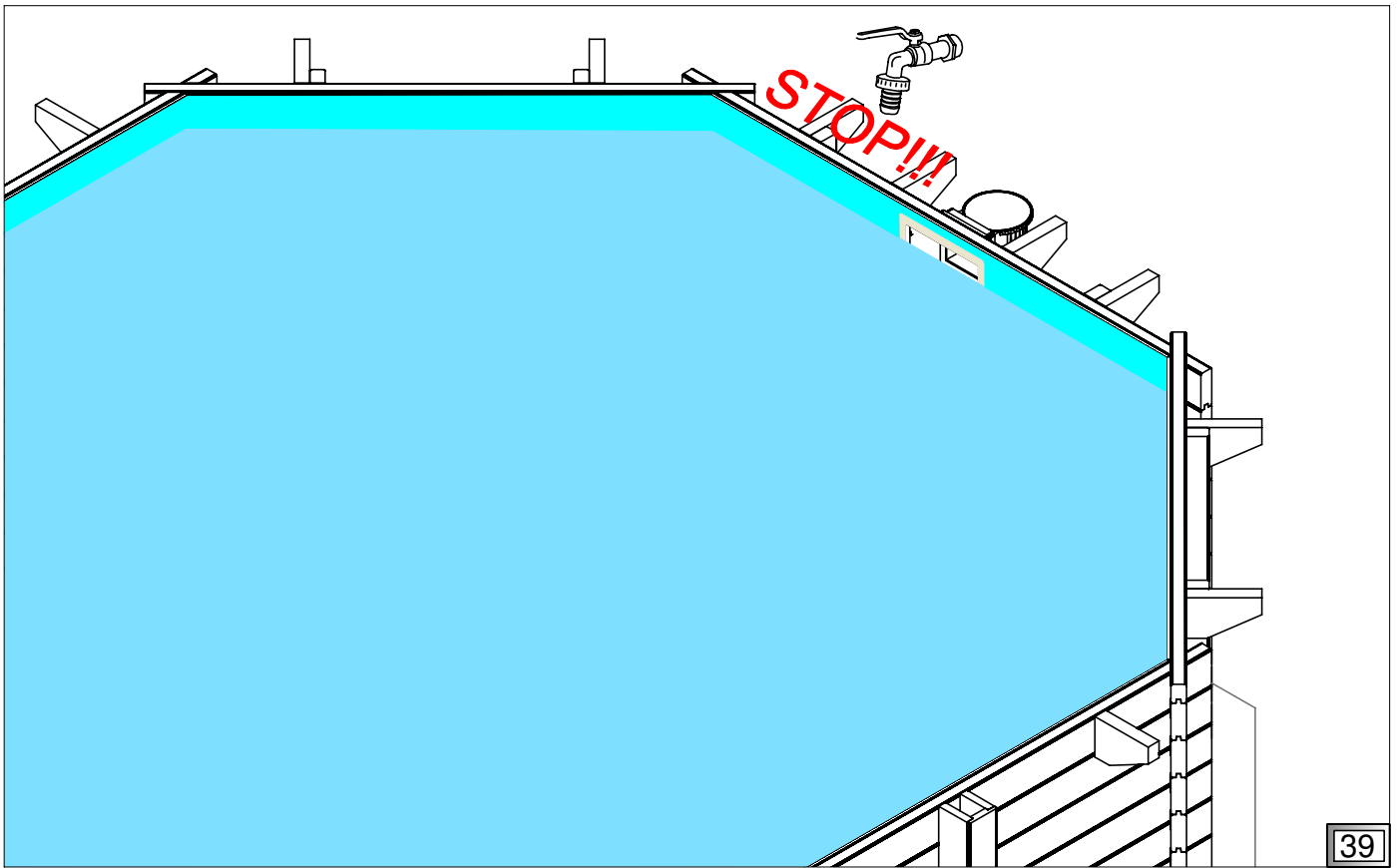

39

PL Taras

GB Terrace

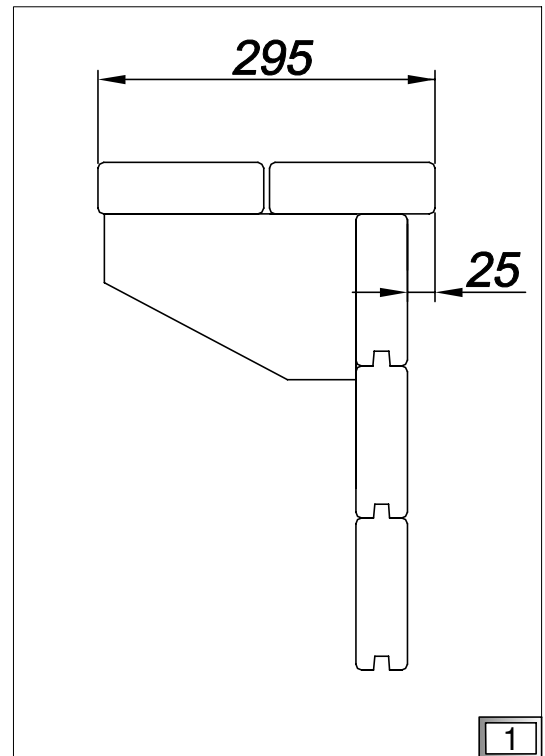
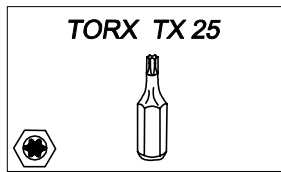
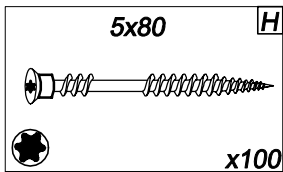
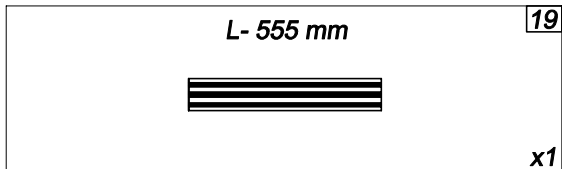
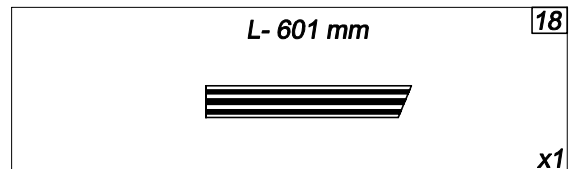
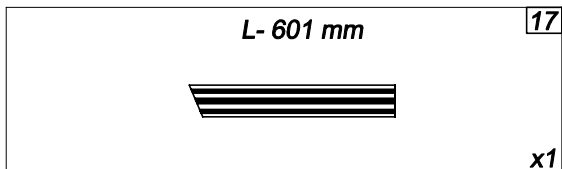
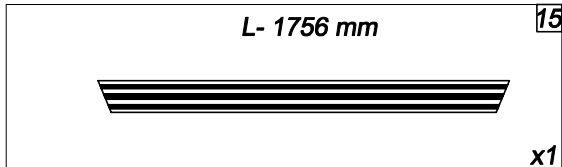
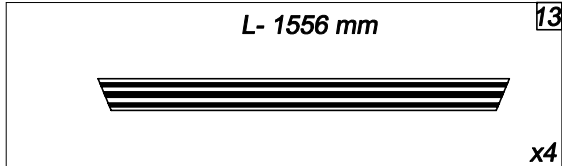
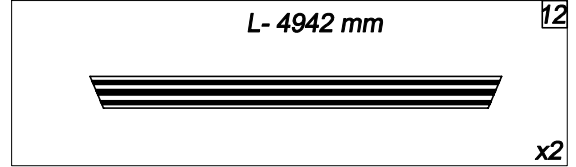
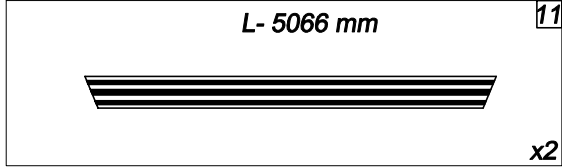

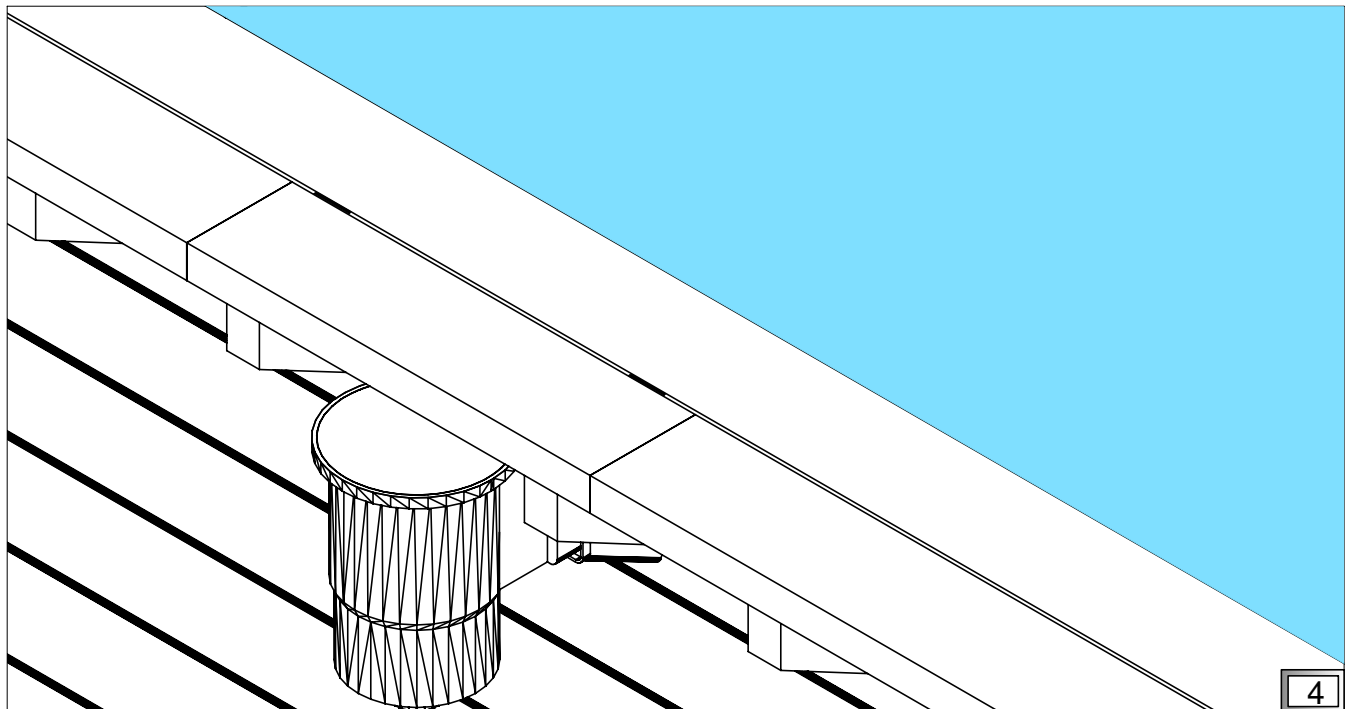
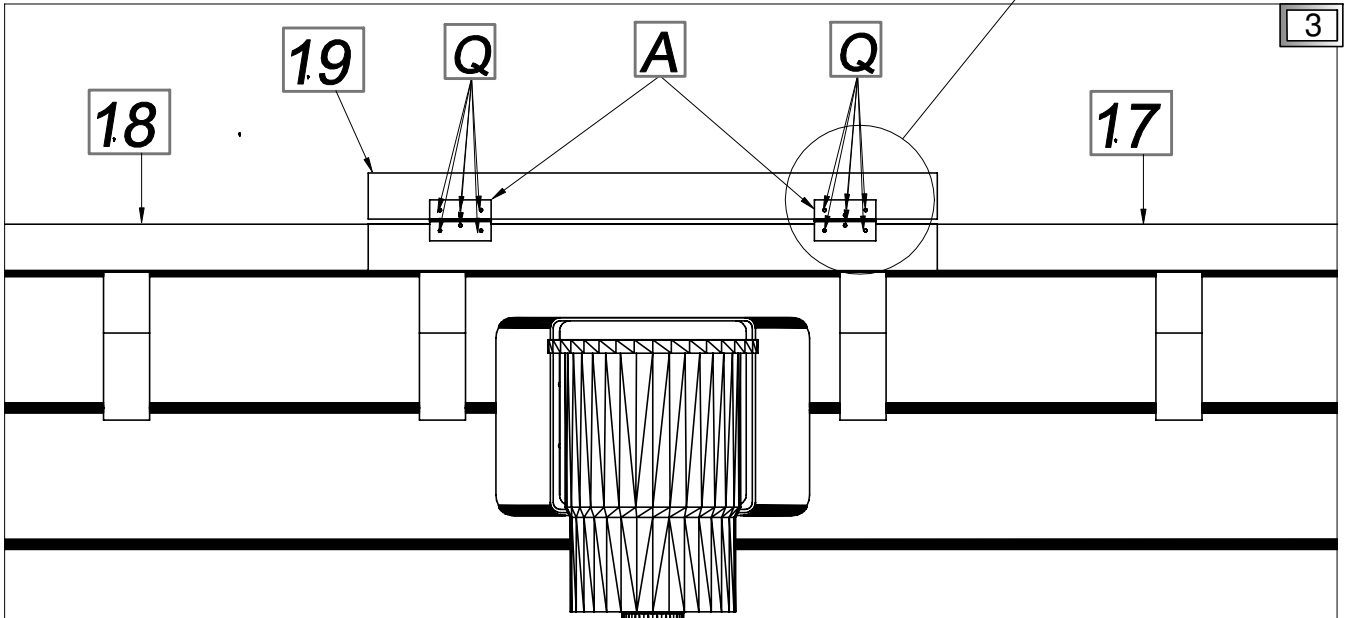
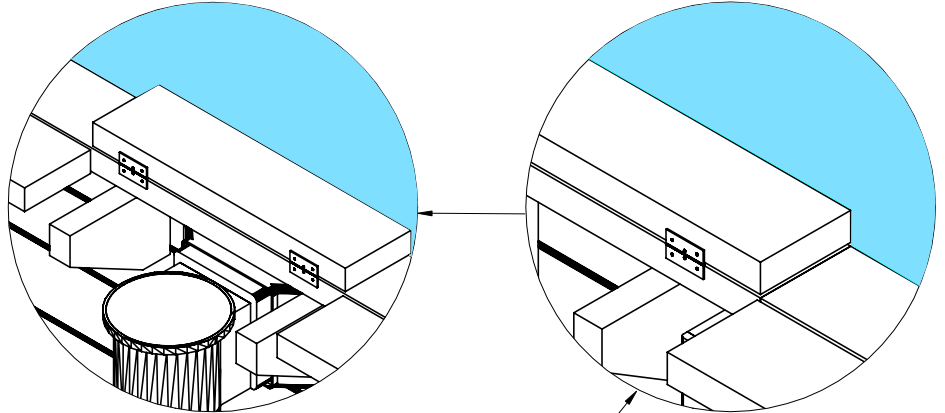
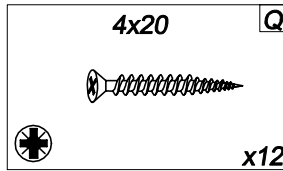
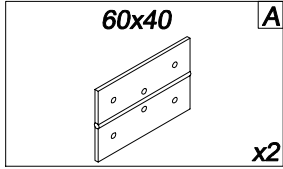

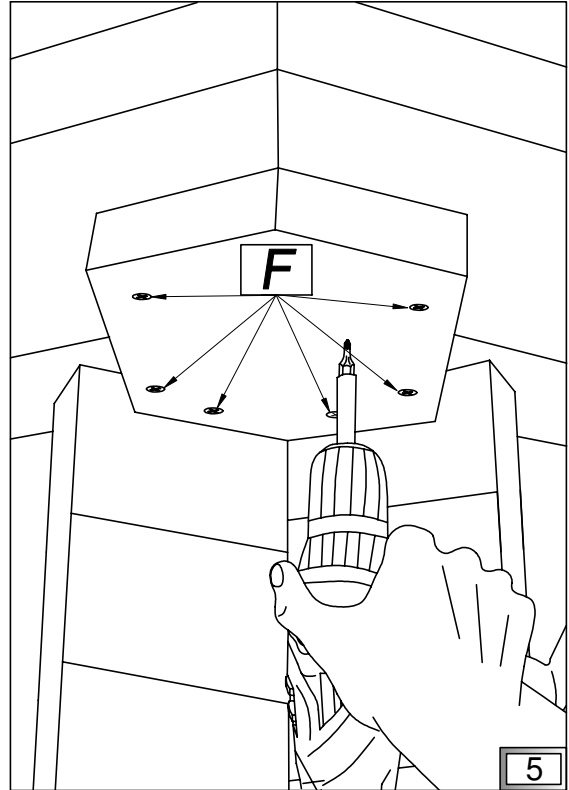
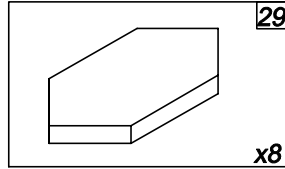
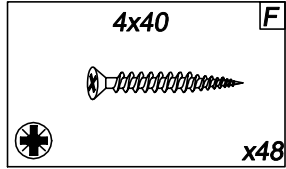

PL Widok od spodu tarasu.

GB View from the bottom of terrace.

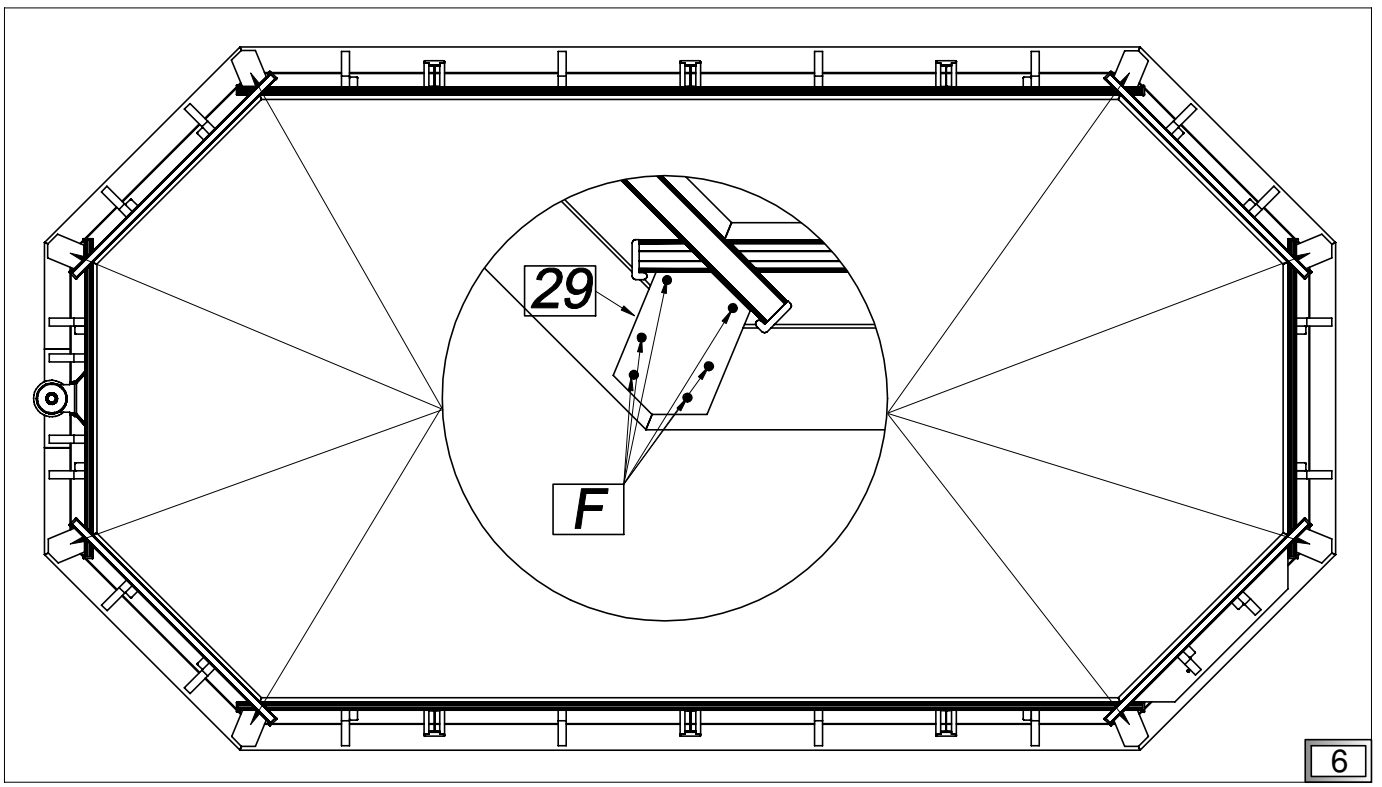

PL Schody drewniane

GB Wooden stairs

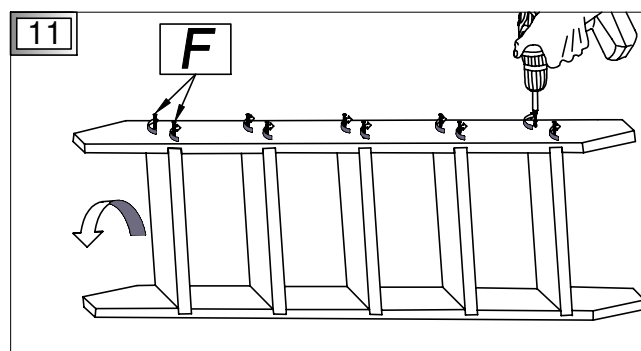
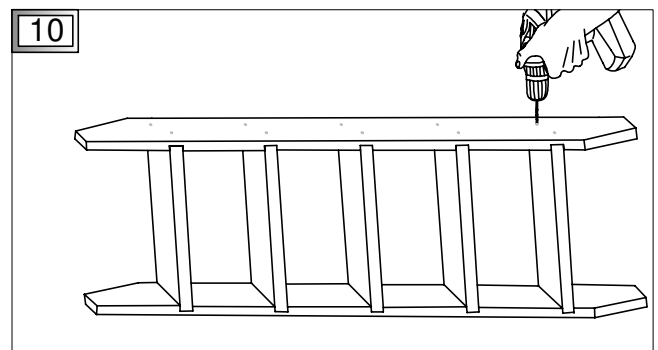
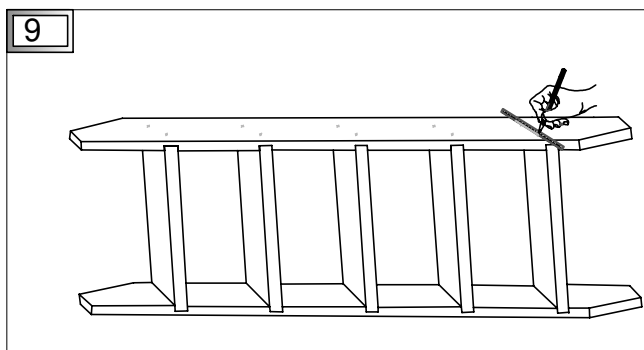
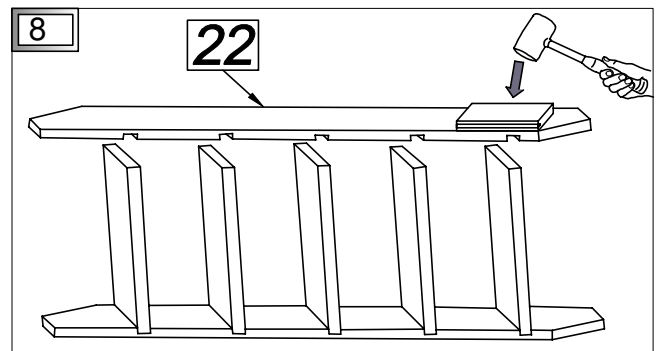
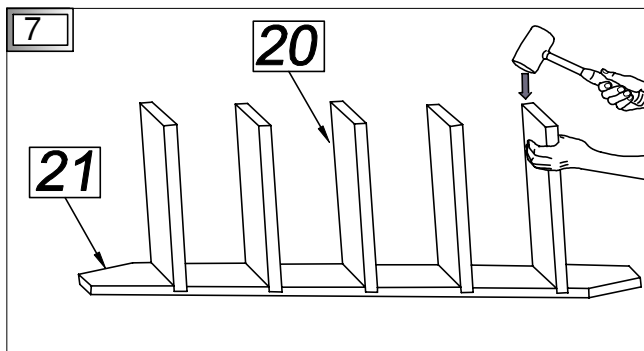
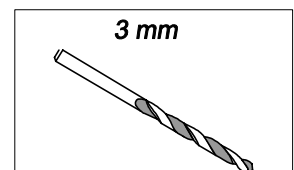
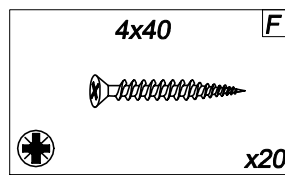
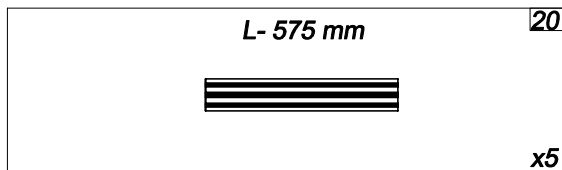
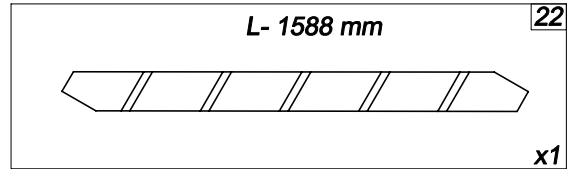
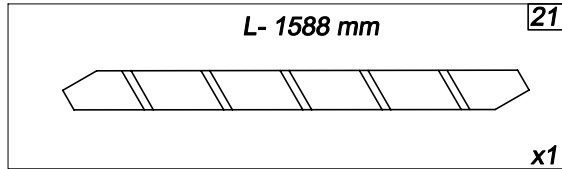

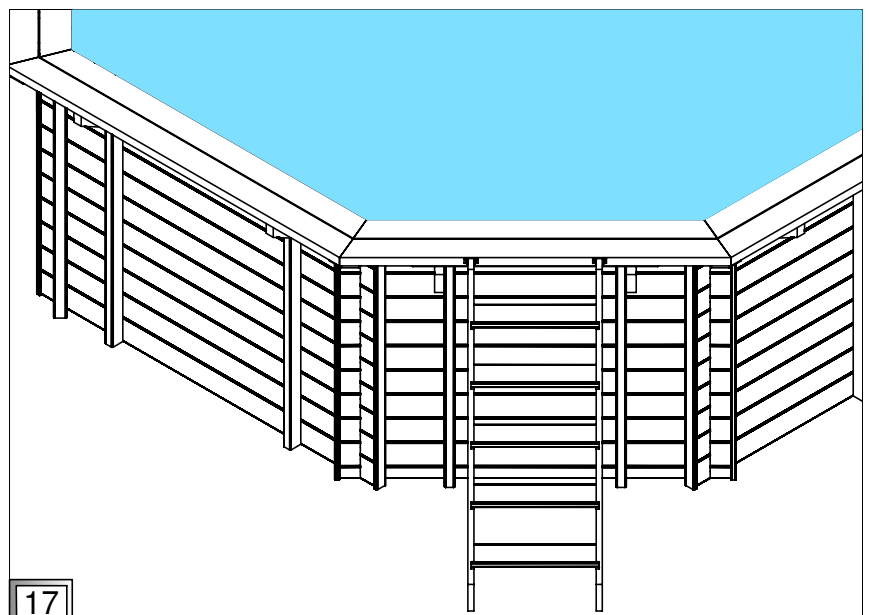
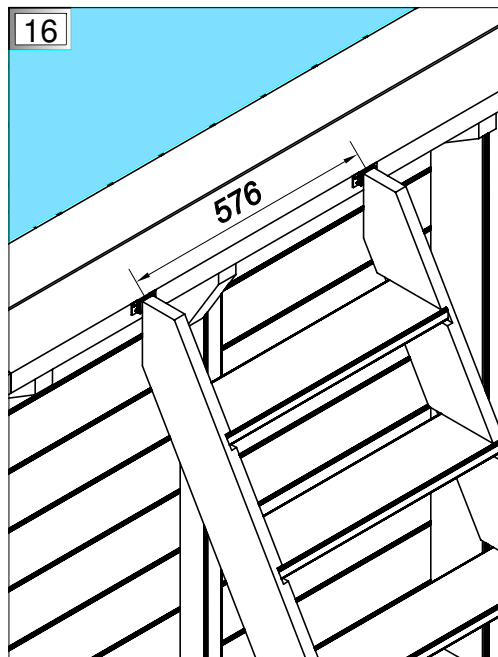
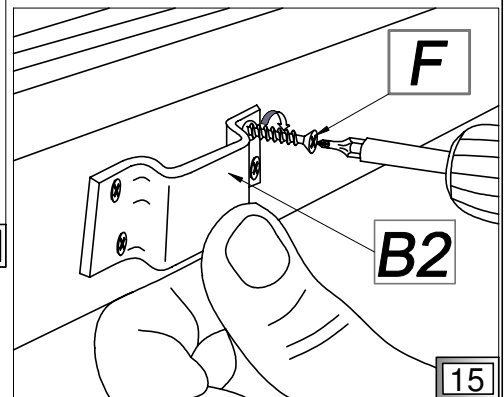
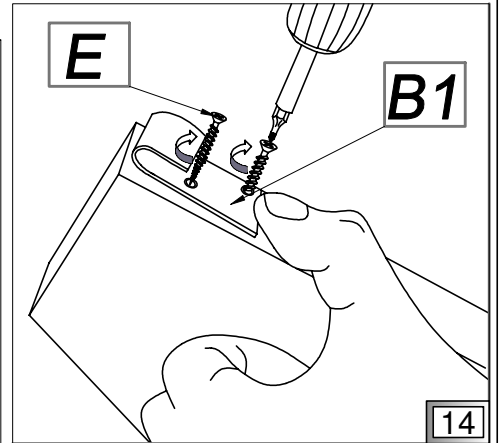
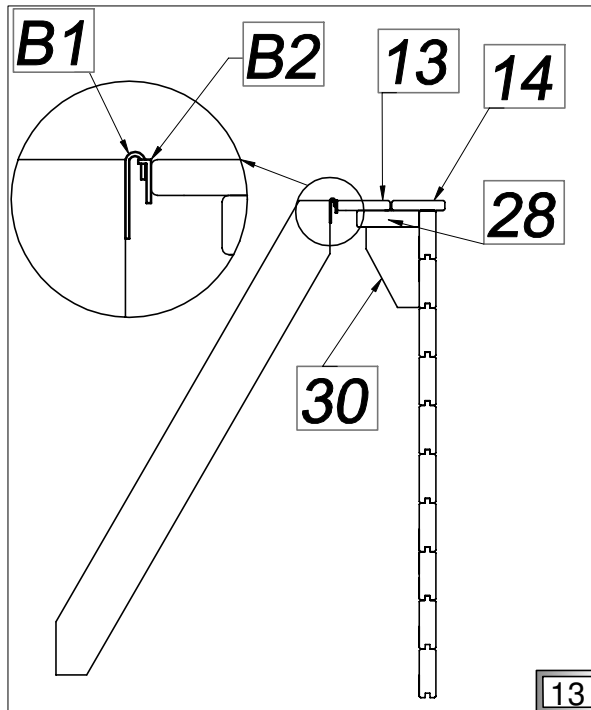
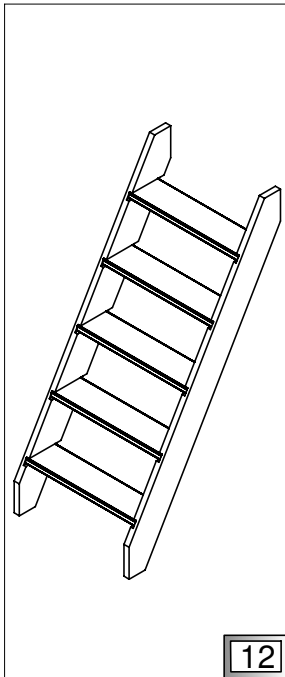
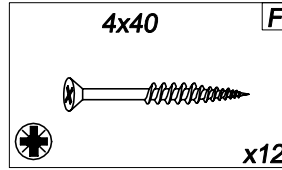
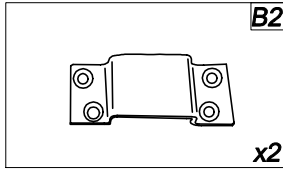
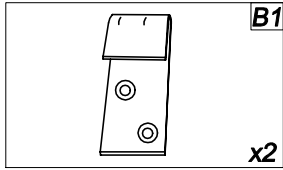

PL Drabinka stalowa

GB Stainless steel ladder

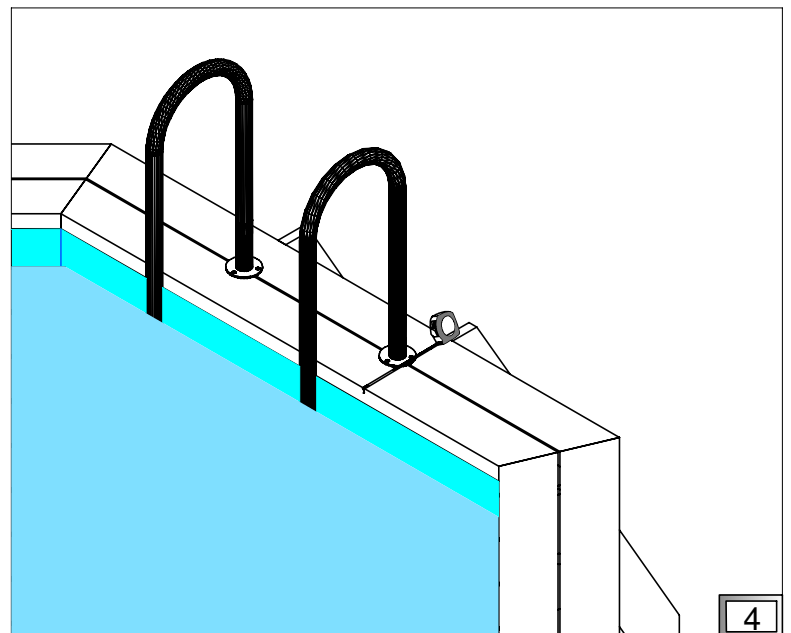
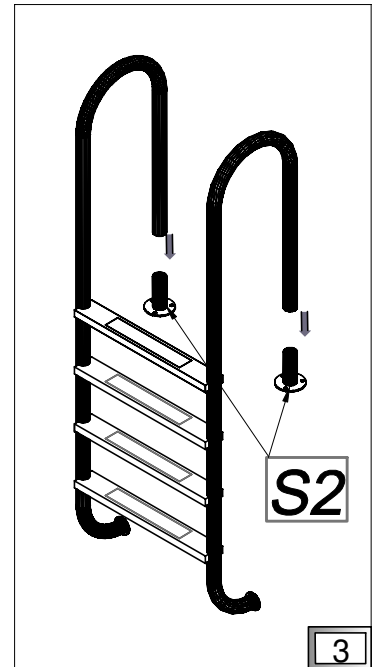
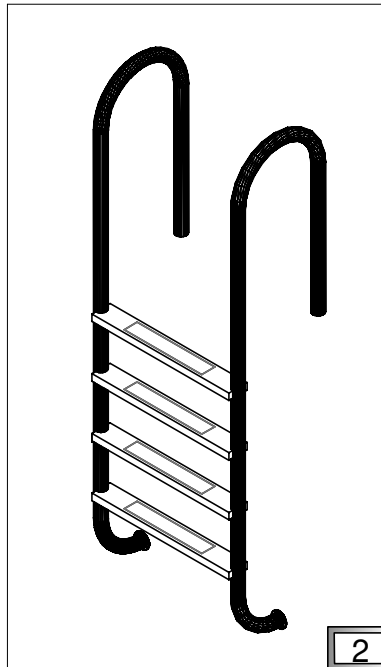
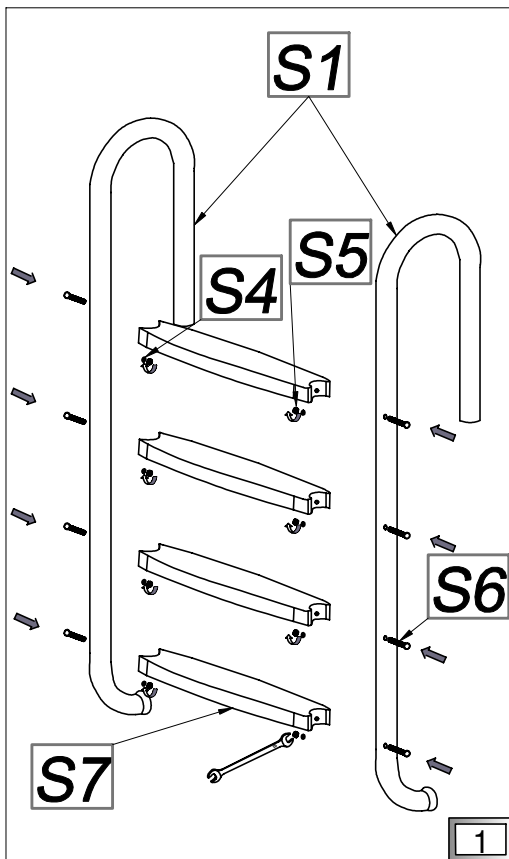
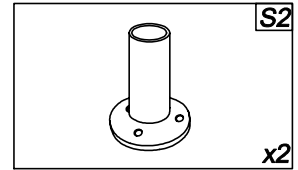
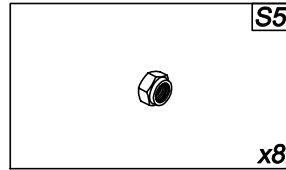
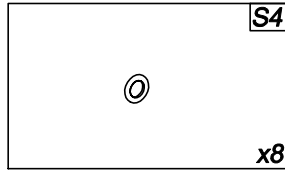
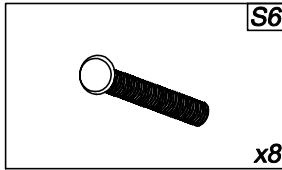
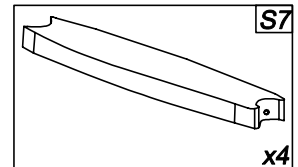
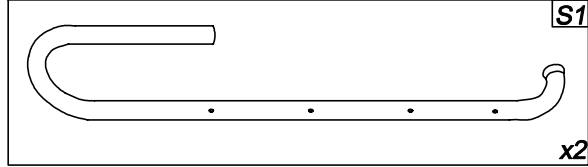
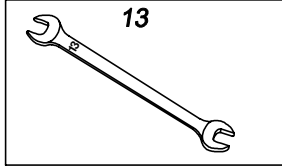

PL Drabinka stalowa

GB Stainless steel ladder

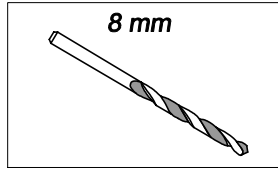
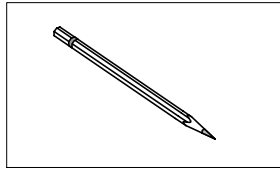
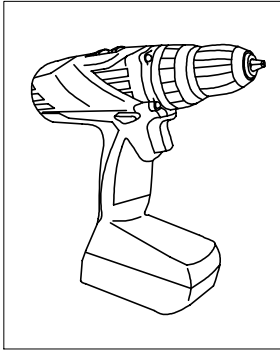
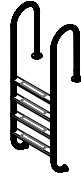

8 mm

PL Otwór wykonać na przelot w celu wprowadzenie okucia S8

GB Make a hole through boards to put in the fittings S8

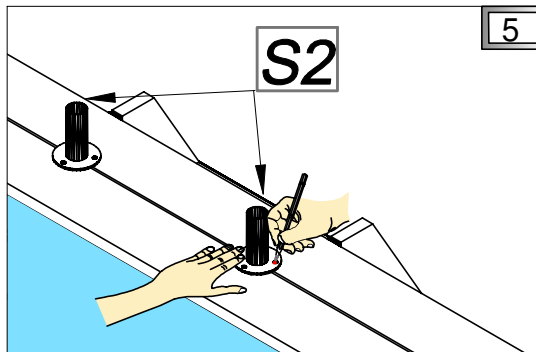

5

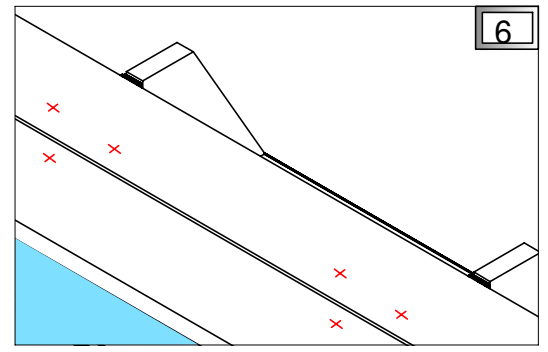

6

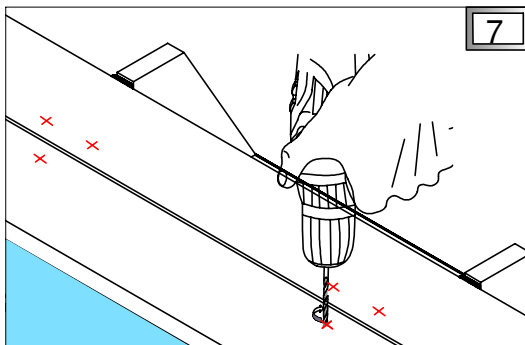

7

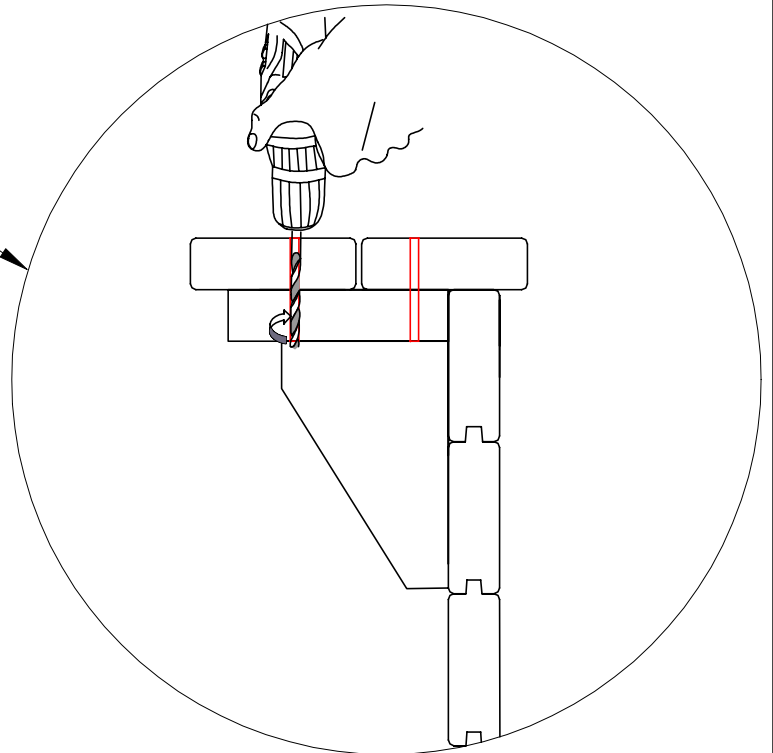

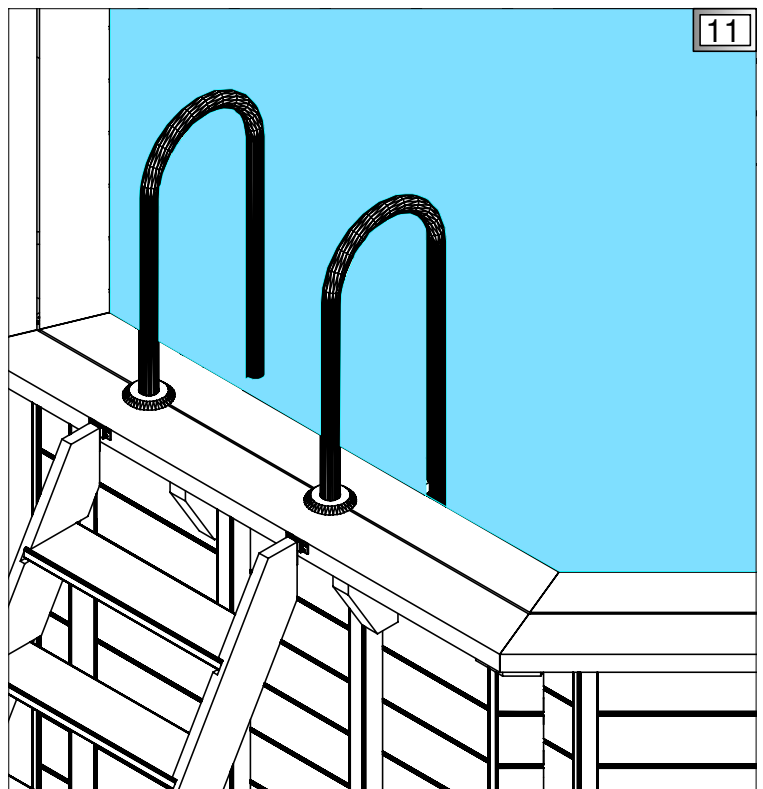
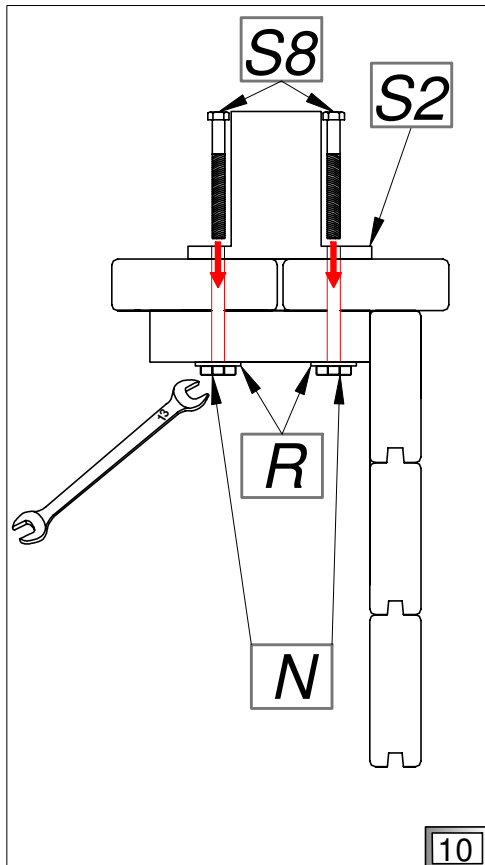
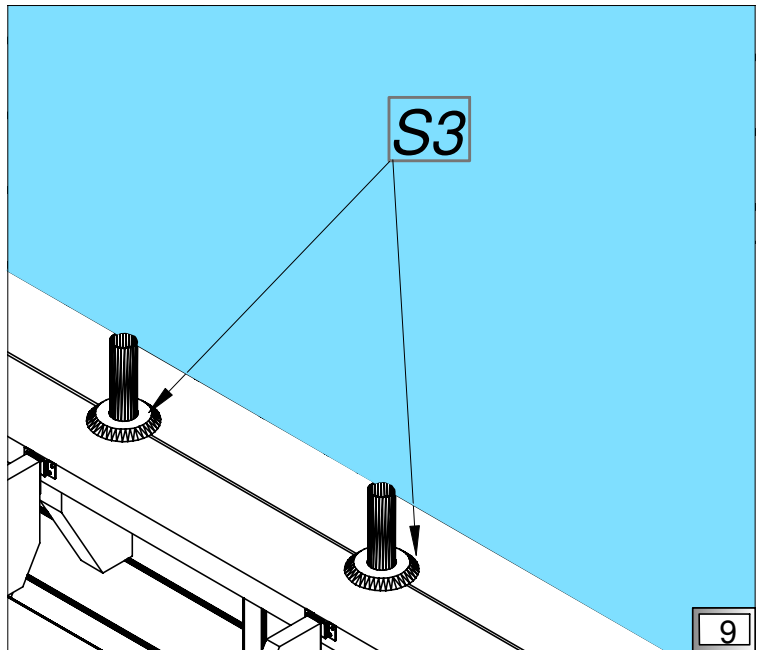
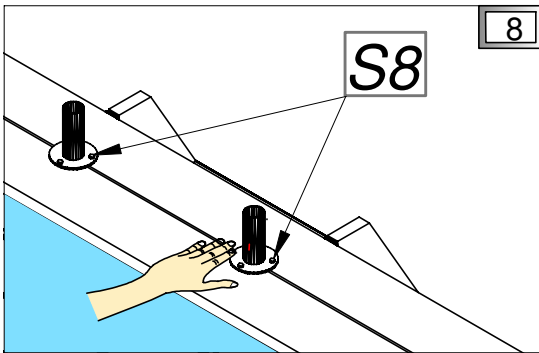
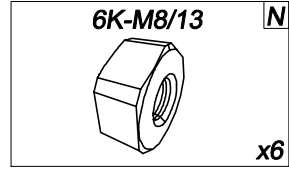
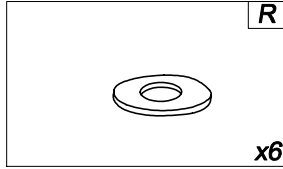
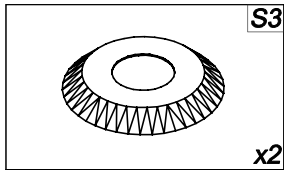
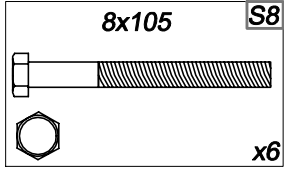
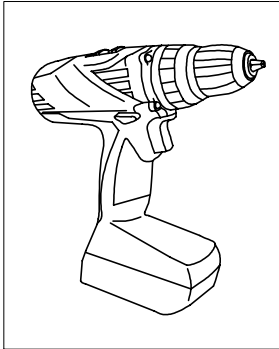
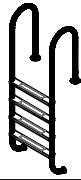

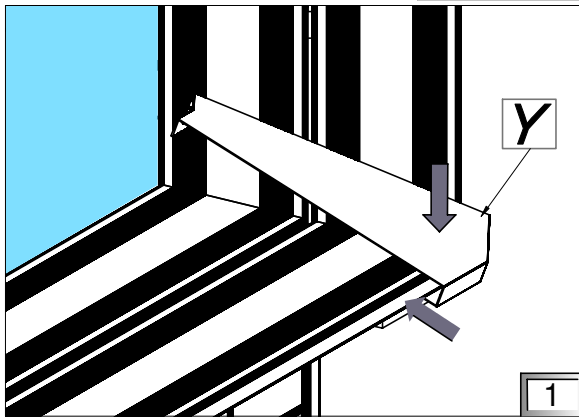
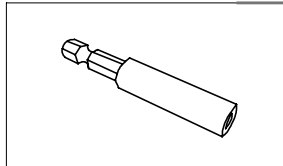
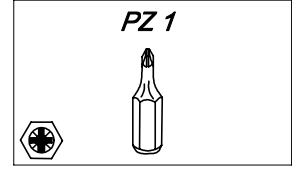
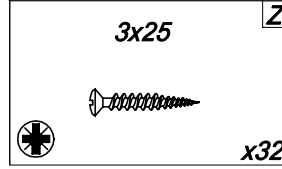
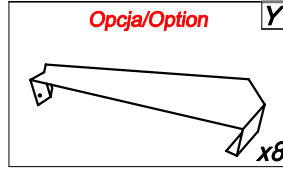
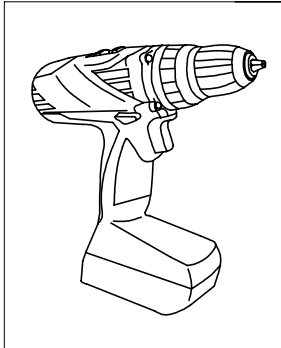

1

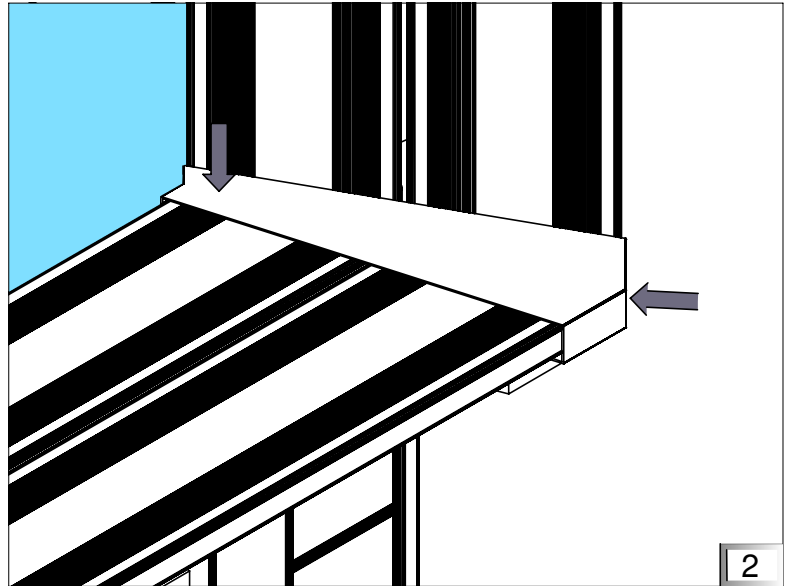

2

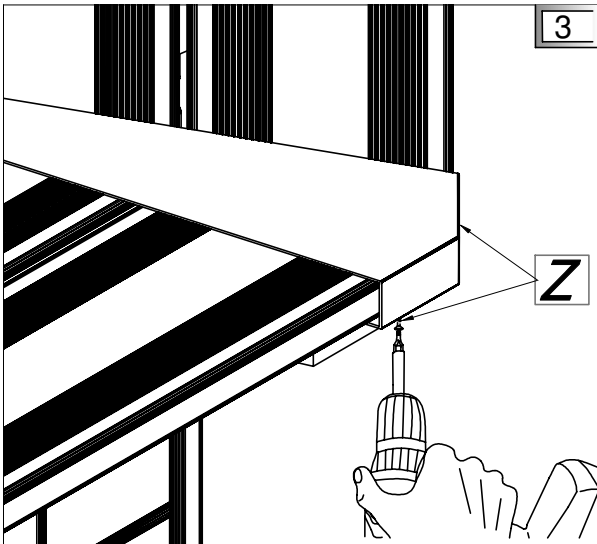

3

Z

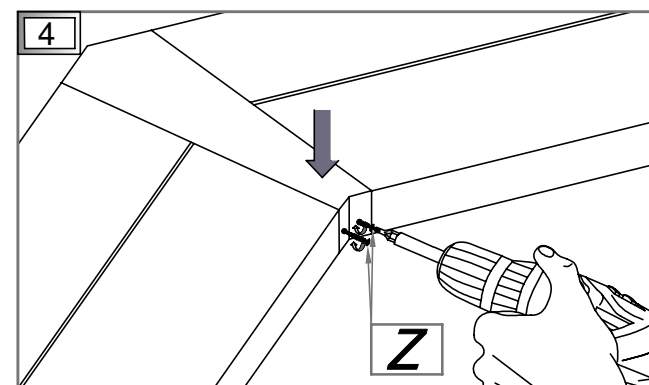

4

Z

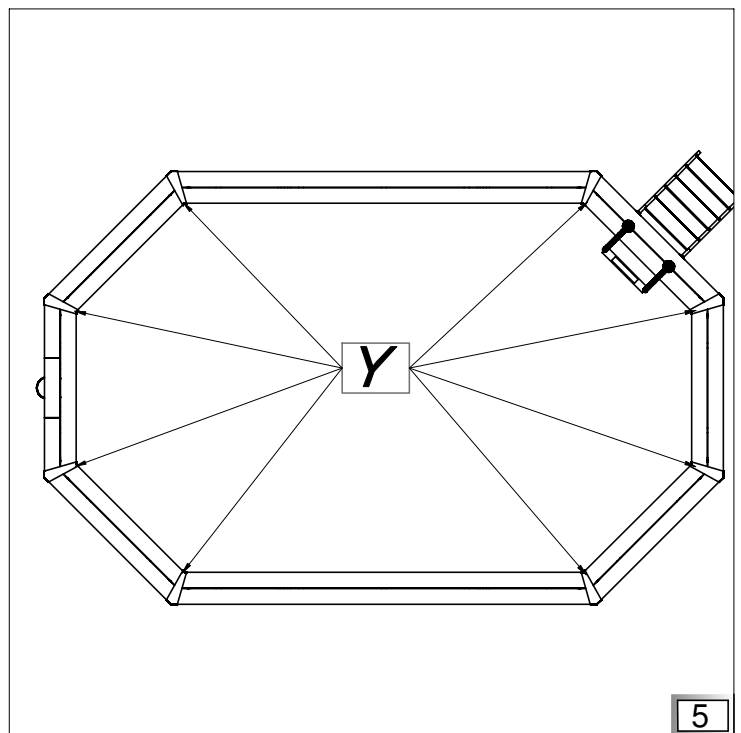

5