

codice prodotto: **NUFINGDC**

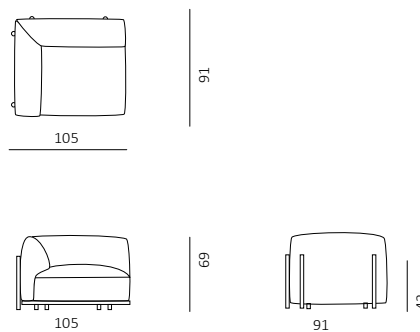

Modulo Davos finale destro struttura in alluminio verniciato a polveri grafite

CONDIZIONI DI UTILIZZO



Medium Conditions: utilizzo HORECA

MATERIALI E FINITURE

Telaio in Alluminio



Grafite

TIPOLOGIA DI PRODOTTO

Non assemblato

IMBALLO

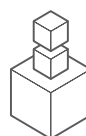

1 pz



27Kg

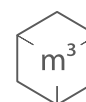

0,81m³



99 x 110 x 74 cm

codice prodotto: **NUSPAGC01**

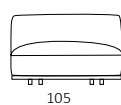
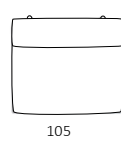

Modulo spalla Davos struttura in alluminio verniciato a polveri grafite



CONDIZIONI DI UTILIZZO



Medium Conditions: utilizzo HORECA

MATERIALI E FINITURE

Telaio in Alluminio



Grafite

TIPOLOGIA DI PRODOTTO

Non assemblato

IMBALLO

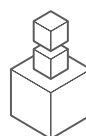

1 pz



25 Kg

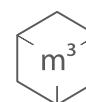

0,70 m³



99 x 95 x 74 cm

codice prodotto: **NUFINSC01**

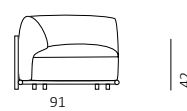
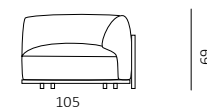
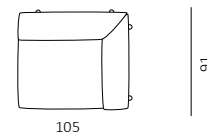

Modulo Davos finale sinistro struttura in alluminio verniciato a polveri grafite



CONDIZIONI DI UTILIZZO



Medium Conditions: utilizzo HORECA

MATERIALI E FINITURE

Telaio in Alluminio



Grafite

TIPOLOGIA DI PRODOTTO

Non assemblato

IMBALLO

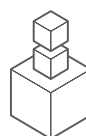

1 pz



27Kg

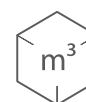

0,81m³



99 x 110 x 74 cm

codice prodotto: **NUTABG**

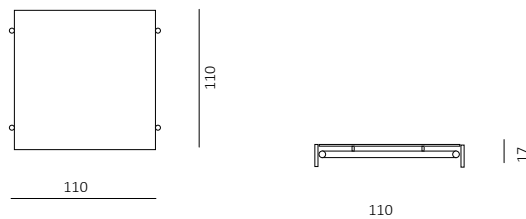

Tavolo basso Davos struttura in alluminio verniciato a polveri grafite e piano in gres porcellanato

CONDIZIONI DI UTILIZZO



Medium Conditions: utilizzo HORECA

MATERIALI E FINITURE

Telaio in Alluminio



Grafite

TIPOLOGIA DI PRODOTTO

Non assemblato

IMBALLO

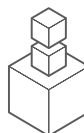

1 pz



20 Kg

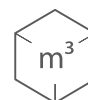

0,26 m³



105 x 105 x 24 cm

codice prodotto: **NULOUGDC**

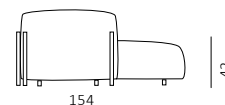
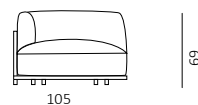
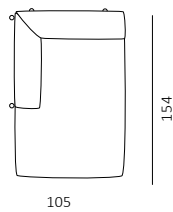

Modulo Davos lounge destro struttura in alluminio verniciato a polveri grafite



CONDIZIONI DI UTILIZZO



Medium Conditions: utilizzo HORECA

MATERIALI E FINITURE

Telaio in Alluminio



Grafite

TIPOLOGIA DI PRODOTTO

Non assemblato

IMBALLO

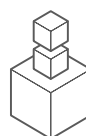

1 pz



35 Kg

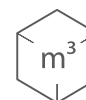

0,27 m³



156 x 110 x 74 cm

codice prodotto: **NULOUGSC**

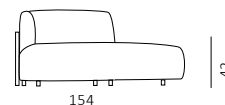
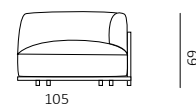
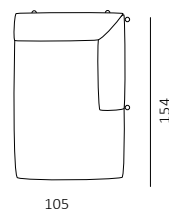

Modulo Davos lounge sinistro struttura in alluminio verniciato a polveri grafite



CONDIZIONI DI UTILIZZO



Medium Conditions: utilizzo HORECA

MATERIALI E FINITURE

Telaio in Alluminio



Grafite

TIPOLOGIA DI PRODOTTO

Non assemblato

IMBALLO

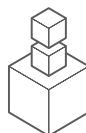

1 pz



35 Kg

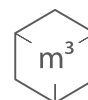

0,27 m³



156 x 110 x 74 cm

codice prodotto: **NUANGOLGC**

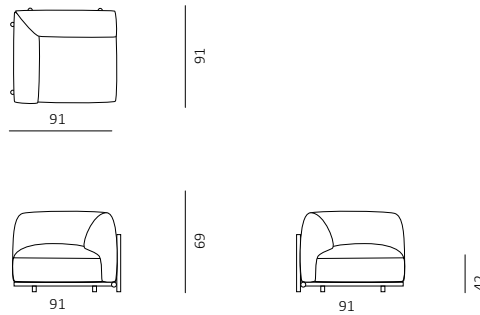

Modulo angolo Davos struttura in alluminio verniciato a polveri grafite e piano in gres porcellanato



CONDIZIONI DI UTILIZZO



Medium Conditions: utilizzo HORECA

MATERIALI E FINITURE

Telaio in Alluminio



Grafite

TIPOLOGIA DI PRODOTTO

Non assemblato

IMBALLO

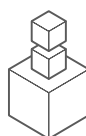

1 pz



27 Kg

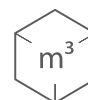

0,73 m³



99 x 99 x 74 cm

codice prodotto: **NUPOLGC**

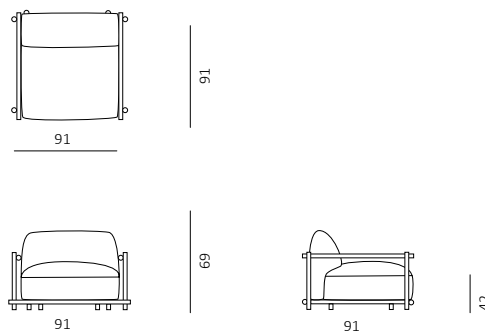

Poltrona Davos struttura in alluminio verniciato a polveri grafite e piano in gres porcellanato

CONDIZIONI DI UTILIZZO

M

Medium Conditions: utilizzo HORECA

MATERIALI E FINITURE

Telaio in Alluminio



Grafite

TIPOLOGIA DI PRODOTTO

Non assemblato

IMBALLO

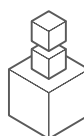

1 pz



26 Kg

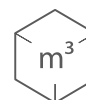

0,90 m³



110 x 110 x 74 cm

codice prodotto: **NUTACEG**

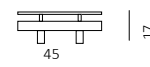
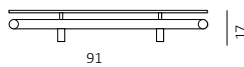
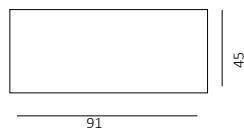

Tavolo basso rettangolare Davos struttura in alluminio verniciato a polveri grafite e piano in gres porcellanato

CONDIZIONI DI UTILIZZO

M

Medium Conditions: utilizzo HORECA

MATERIALI E FINITURE

Telaio in Alluminio



Grafite

TIPOLOGIA DI PRODOTTO

Non assemblato

IMBALLO

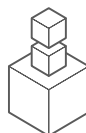

1 pz



15 Kg

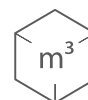

0,12 m³



99 x 50 x 24 cm

CURA E MANUTENZIONE**ALLUMINIO**

Per mantenere pulito l'alluminio è sufficiente una bacinella con acqua pulita tiepida, un detergente solido o liquido neutro – non abrasivo e non a base di ammoniaca, candeggina o alcool – panni morbidi e una spugna non abrasiva. Utilizzare il panno morbido per asciugare ed evitare la formazione di aloni. Si raccomanda di utilizzare solo acqua tiepida a temperatura massima di 30°. Nel caso di macchie persistenti utilizzare una soluzione di aceto, sapone di Marsiglia neutro o bicarbonato (un cucchiaino di sapone/bicarbonato per ogni litro di acqua).

CARE AND MAINTENANCE**ALUMINUM**

To maintain the aluminium clean use a basin with warm clean water, a solid or neutral liquid detergent (non-abrasive and not ammonia, bleach or alcohol-based) soft cloths and a non-abrasive sponge. Use a soft cloth to prevent halos. It is recommended to use only lukewarm water (maximum 30°C). In case of persistent stains use a solution of vinegar, neutral Marseille soap or bicarbonate (a spoonful of soap/bicarbonate for each liter of water).