

EST.
1877

SIMPLIFIX ISOFIX BASE

Only for use with the Simplicity Infant Carrier
Group 0+ Birth to 13kgs (29lbs)
Birth to approximately 9-12 months

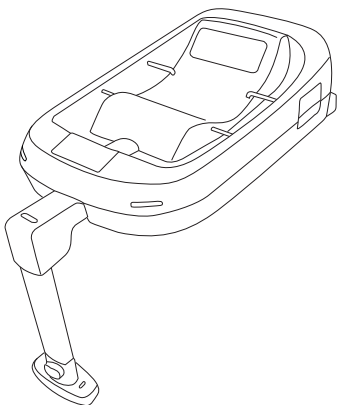

Silver Cross[®]

THE BEST START IN LIFE



**IMPORTANT: KEEP THESE INSTRUCTIONS
FOR FUTURE REFERENCE**

Contents

Page

- 2 Very important
- 3 Possible seating positions
- 3-4 Important safety guide
- 5 Parts list
- 6-9 Installing the Simplifix ISOFIX Base
- 10 Detaching the Simplicity Infant Carrier from the Simplifix ISOFIX Base
- 10 Removing the Simplifix ISOFIX base from the vehicle
- 11 Looking after the Simplifix ISOFIX Base
- 11 Please read the following safety notes
- 11 Final check list
- 11 Warranty
- 11 Notice

VERY IMPORTANT

Please read the whole of this instruction guide carefully. Failure to do so could put your child in danger.

The Simplifix ISOFIX Base can only be used with the Simplicity Infant Carrier.

The base with its adjustable front support leg has been tested and certified according to ECE R44.04 Semi-Universal approval, only when used in combination with the Silver Cross Simplicity Infant Carrier. This approval will be invalidated if you make any modification or alteration to the base or infant carrier. Any modifications can only be made by the manufacturer.



NEVER use on a passenger seat fitted with a front airbag. It is VERY DANGEROUS AND ILLEGAL.

Possible Seating Positions

The Simplifix ISOFIX Base must be fitted in accordance with the user guide.

! Not all infant carrier bases fit all vehicles. For advice as to the suitability of this infant carrier base please consult the vehicle application list before you purchase the base and make sure that the make, model and year of your vehicle/s is suitable. If you are in any doubt please contact Silver Cross customer services on 0845 8726900.

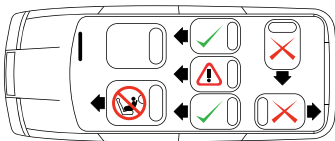

! Please check vehicle application list supplied with base

Please consult the vehicle handbook to locate the vehicle ISOFIX points.

Important: Safety Guide

! Never use the Silver Cross Simplifix ISOFIX Base on a passenger seat fitted with a front airbag. It is **VERY DANGEROUS AND ILLEGAL**.

Make sure that your vehicle/s is listed in the vehicle application list which is provided with the base.

We strongly recommend that when using the Simplicity Infant Carrier whether in or out of the vehicle that you take your child out at regular intervals, especially on long journeys. This will help relieve pressure on the baby's spine and lower back area.

Read the whole instruction guide and make sure that you fully understand how to install and use the Simplifix Base correctly.

Always keep your instruction guide with the Simplifix ISOFIX Base. It is recommended that the compartment at the back of the Simplicity Infant Carrier can be used for storing the instructions.

Do not place anything such as a towel or cushion under the Simplifix ISOFIX Base. This could affect the performance of the base in an accident.

Never buy a second hand base.

Always replace a Simplifix ISOFIX Base after an accident. It may have unseen damage.

Always secure the Simplifix ISOFIX base on the vehicles ISOFIX points.

All occupants in the vehicle must be correctly restrained complying with the current law.

Do not place any objects in the foot well in front of the Simplifix ISOFIX Base.

Loose objects in the vehicle must be correctly secured when travelling.

Cover the Simplifix ISOFIX Base if it is left in direct sunlight. Plastic and metal surfaces get very hot and could burn.

Do not make unauthorised modifications or alterations to the Simplifix ISOFIX Base.

Do not allow children to play with or adjust the Simplifix ISOFIX Base.

Do not leave children alone in the vehicle.

Do not place the Simplifix ISOFIX Base on a table or work top, always use the floor.

Make sure your Simplifix ISOFIX Base does not become trapped in the door of the vehicle or by a folding seat.

Make sure that all folding vehicle seats are securely latched.

Do not fit the Simplifix ISOFIX Base on a side or rear facing vehicle seat.

Always store the Simplifix ISOFIX Base in a safe, dry place when it is not being used.

Avoid storing the Simplifix ISOFIX Base near a direct heat source such as a radiator and do not place heavy objects on top of the Simplifix ISOFIX Base.

 **WARNING:** Infant Carrier bases can mark vehicle seat upholstery. Silver Cross cannot be held responsible for damage or marking to vehicle seat upholstery. A pair of plastic ISOFIX guides (included with the Simplifix ISOFIX Base) should always be used to help avoid damaging vehicle seat upholstery.

Simplifix ISOFIX Base parts list:

- | | |
|--|---|
| 1 Base | 10 Support leg |
| 2 Carry handle | 11 Support leg adjuster button |
| 3 ISOFIX connector arms | 12 Support leg pressure indicators |
| 4 ISOFIX connector arms extension paddle lever | |
| 5 ISOFIX connection indicator | To remove the infant carrier from the base use the infant carrier release handle on the back of the Simplicity Infant Carrier |
| 6 ISOFIX connection release handles | |
| 7 Plastic ISOFIX guides | |
| 8 Infant carrier connection bars | |
| 9 Infant carrier connection indicators | |

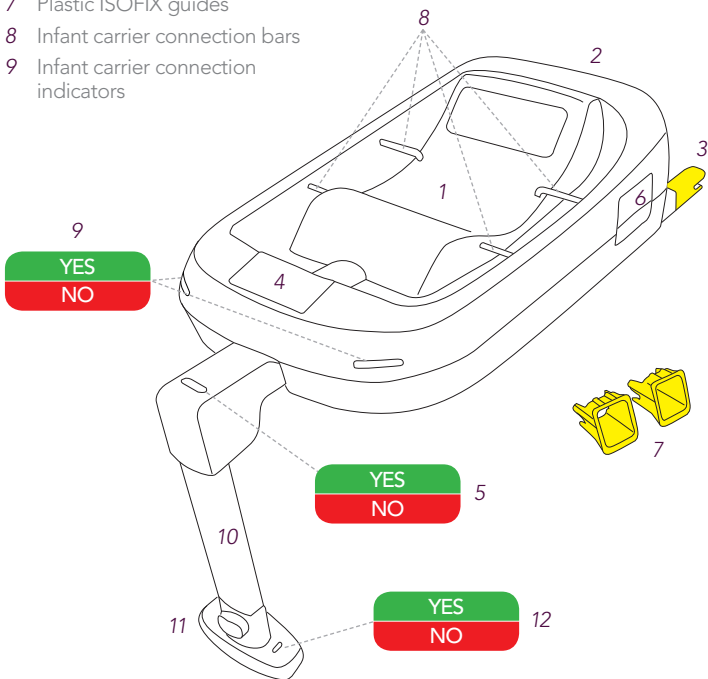

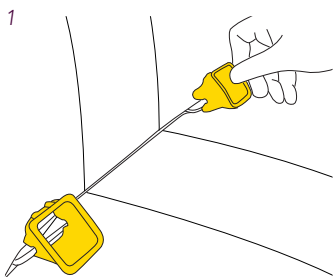

Installing the Simplifix ISOFIX Base

Make sure that your vehicle has ISOFIX anchor points and is approved in the vehicle application list which is supplied with the base.

Locate the vehicle ISOFIX points. If this is a problem consult the vehicle manual. They are usually between the vehicle seat base and back.

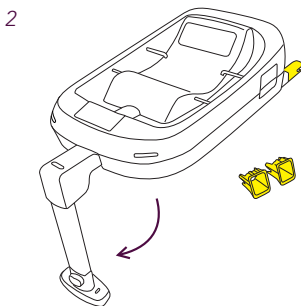

1 Insert the two plastic ISOFIX guides and hook them onto the vehicle ISOFIX points. The plastic guides can help identify the vehicle ISOFIX points and make installation easier. They can also help with the protection of your vehicle seat.

2 Pull out the support leg from the attachment.

3 Lift the paddle lever, centrally positioned at the front of the base and push the front support leg housing towards the base to fully extend the ISOFIX arms.

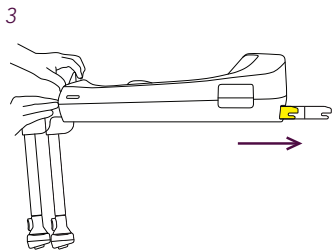

4

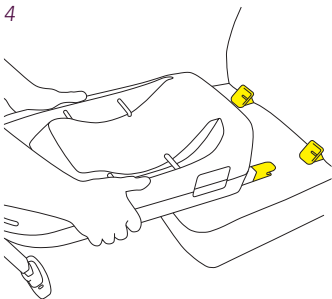

4 Connect the ISOFIX arms onto the vehicle ISOFIX points. Firmly pull the base towards you making sure that both arms are connected and check that the ISOFIX connection indicator is now showing green (parts list no.5)

5 Again lift the paddle lever and firmly push the base towards and up against the back of the vehicle seat. Make sure that the back of the base is now firmly up against the rear of the vehicle seat. Check again that the ISOFIX connection indicator is showing green (parts list no.5). The base should now be secure and stable.

5

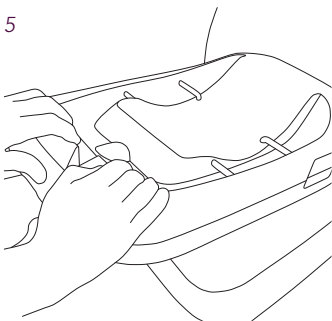

6

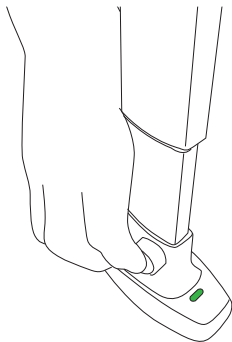

Installing the Simplifix ISOFIX Base (continued)

- 6 Push the adjustment button and adjust the support leg so that it makes full and firm contact with the vehicle floor. The two pressure monitors at the base of the support leg must turn from red to green confirming firm contact.

 Do not place the front support leg on a floor storage compartment lid. The front support leg **MUST** make full and firm contact with the vehicle floor.

Make sure that the support leg does not raise the base from the surface of the vehicle seat.

 Not all infant carrier bases fit all vehicles. For advice as to the suitability of this infant carrier base please consult the vehicle application list before you purchase the base and make sure that the make, model and year of your vehicle/s is suitable. If you are in any doubt please contact Silver Cross customer services on 0845 8726900.

7

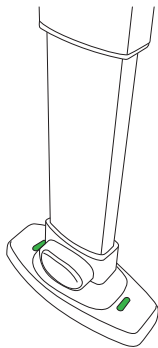

- 7 Check that the front support leg clicks into position and is correctly adjusted.

8

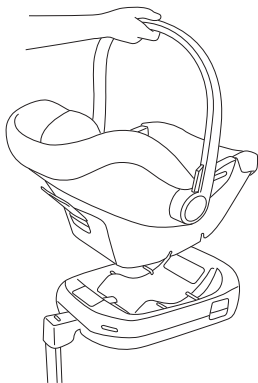

- 8 Lower the Simpliflix Infant Carrier on to the Simpliflix ISOFIX Base and make sure that all 4 connection bars engage firmly and click into position on the base connection points (parts list no.8). Make sure the infant carrier handle is in the upright position and that it “clicks” into place.
- 9 Lift the Simpliflix Infant Carrier to make sure that all four connections have engaged correctly and the two connection indicators have changed from red to green (parts list no.9).

9

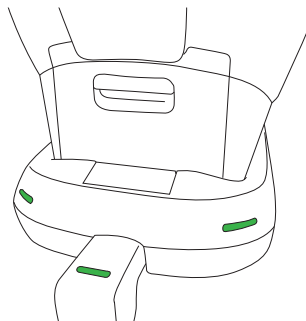

YES

NO

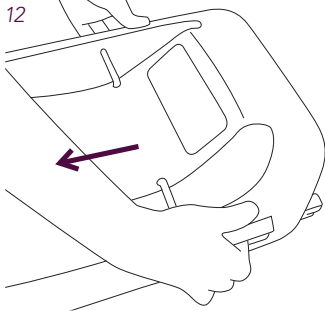
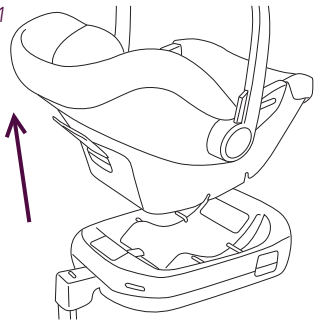
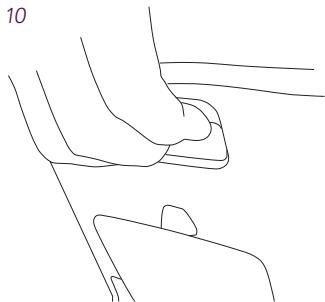

Detaching the Simplicity Infant Carrier from the Simpliflix ISOFIX Base

- 10 Pull up the release handle on the back of the Simplicity Infant Carrier. The two indicators on the front of the Simpliflix ISOFIX Base will turn from green to red to indicate that the infant carrier has been detached from the base correctly. (parts list no.9)
- 11 Carefully lift the Simplicity Infant Carrier from the Simpliflix ISOFIX Base.

Removing the Simpliflix ISOFIX base from the vehicle

- 12 Only remove the base from the vehicle when the infant carrier is not attached. Disconnect the ISOFIX connector arms by lifting either or both release paddle handles positioned on the side of the base. The infant carrier connection indicator should have turned from green to red, the base should now be disconnected (parts list no.5).

Push the support leg adjustment button adjust the front support leg to the required length and reattach to the holder positioned under the base. Carefully remove from your vehicle. There is a carry handle located centrally between the ISOFIX arms to help you carry the base. The ISOFIX base can be left installed in the vehicle.

Looking after your Simplifix

ISOFIX Base

Wipe clean using a mild hand soap and warm water. You must not use detergents, solvents or strong soaps. This may weaken the base shell. You must not remove, dismantle or alter any part of the base. You must not oil or lubricate any part of the base.

Please read the following safety notes



The Silver Cross Simplicity Infant Carrier is the only infant carrier that is compatible with the Simplifix ISOFIX Base.

Never use the Simplifix ISOFIX Base on a passenger seat fitted with a front airbag. It is very dangerous and it is illegal.

Final checklist before journey

Check

- You have **NOT** fitted the Simplifix ISOFIX Base on a passenger seat fitted with an airbag.
- The Simplifix ISOFIX Base is correctly fitted with no excessive movement forward or to the side.
- All indicators are green.

YES

NO

Warranty

All Silver Cross products are guaranteed for a period of 12 months against faulty workmanship, when the product is used correctly according to the instruction manual.

Notice

1. The category of this child restraint is "semi-universal" and it is suitable for installation in the vehicles and in the seat positions indicated in the vehicle application list inside this packaging.
2. Other vehicles and seat positions may also be suitable for this restraint system.
3. If in doubt, consult the manufacturer or retailer.
4. This is an ISOFIX system for children. Approved under Regulation Number 44, Supplement 5, 04 series of amendments, for general use in vehicles equipped with an ISOFIX fastening system.
5. It can be fitted in vehicles with positions approved as "ISOFIX" positions (as listed in the vehicle manual), depending on the category of child seat and the fastening systems.
6. The mechanism has been designed for an ISOFIX size class and weight group of: 0 -13kg and Class E.

Important : Guide de sécurité

N'utilisez jamais la base ISOFIX Simplifix de Silver Cross sur un siège passager dont l'airbag est activé. C'est très dangereux et illégal.

Assurez-vous que votre véhicule figure dans la liste des applications de véhicule fournie avec la base.

Nous vous recommandons fortement de sortir régulièrement votre enfant de son siège, que vous utilisiez le siège à l'intérieur ou à l'extérieur du véhicule, surtout lorsque vous faites de longs trajets. Cela permettra de soulager la colonne vertébrale et la partie lombaire de votre enfant.

Lisez le manuel d'instructions au complet et assurez-vous de bien comprendre comment installer et utiliser correctement la base Simplifix.

Conservez toujours le guide d'instructions avec la base ISOFIX Simplifix. Il est recommandé d'utiliser le compartiment à l'arrière du siège auto Simplicity pour ranger le guide d'instructions.

Ne placez aucun objet (p. ex. une serviette ou un coussin) sous la base ISOFIX Simplifix. Cela pourrait réduire la performance de la base en cas d'accident.

N'achetez jamais une base d'occasion.

Remplacez toujours une base ISOFIX Simplifix après un accident, car elle peut comporter des dommages invisibles.

Fixez toujours la base ISOFIX Simplifix sur les points d'ancrage ISOFIX du véhicule.

Tous les occupants du véhicule doivent être correctement attachés, conformément à la législation en vigueur.

Ne placez aucun objet dans la zone des pieds en face de la base ISOFIX Simplifix.

Les objets mobiles doivent être bien immobilisés à l'intérieur du véhicule lorsque vous voyagez.

Recouvrez la base ISOFIX Simplifix si elle est directement exposée aux rayons du soleil. Les surfaces en plastique et en métal peuvent devenir très chaudes et provoquer des brûlures.

Ne faites aucune modification ou transformation non autorisée sur la base ISOFIX Simplifix.

Ne laissez pas les enfants jouer ou régler la base ISOFIX Simplifix.

Ne laissez pas les enfants seuls dans le véhicule.

Ne mettez pas la base ISOFIX Simplifix sur une table ou un plan de travail, posez-la toujours par terre.

Assurez-vous que la base ISOFIX Simplifix ne reste pas coincée dans la portière du véhicule ou sous un siège rabattable.

Assurez-vous que tous les sièges rabattables sont correctement bloqués.

N'installez pas la base ISOFIX Simplifix sur un siège disposé latéralement ou dans le sens contraire à la marche.

Rangez toujours la base ISOFIX Simplifix dans un endroit sécurisé et sec lorsque vous ne l'utilisez pas.

Évitez de ranger la base ISOFIX

Simpliflx à proximité d'une source de chaleur directe, comme un radiateur, et ne posez pas des objets lourds sur la base ISOFIX Simpliflx.

AVERTISSEMENT : Les bases de siège auto peuvent laisser des marques sur le revêtement des sièges du véhicule. Silver Cross ne peut être tenu responsable des dommages ou des marques laissées sur le revêtement des sièges du véhicule. Il est recommandé d'utiliser deux dispositifs de guidage en plastique ISOFIX (inclus avec la base ISOFIX Simpliflx) pour éviter d'endommager le revêtement des sièges du véhicule.

 Ne placez pas le pied de maintien avant sur le couvercle d'un compartiment de rangement au sol. Le pied de maintien avant DOIT être entièrement à plat sur le plancher du véhicule. Assurez-vous que le pied de maintien ne soulève pas la base de la surface du siège du véhicule.

 Toutes les bases de siège auto ne s'adaptent pas à tous les véhicules. Pour obtenir de l'aide concernant l'utilisation possible de cette base de siège auto, veuillez consulter la liste des applications du véhicule avant d'acheter la base, et assurez-vous que la marque, le modèle et l'année de construction de votre véhicule sont adaptés.

Entretien de votre base ISOFIX Simpliflx

Nettoyez avec du savon doux pour les mains et de l'eau chaude. N'utilisez pas de détergents, de solvants ou autres savons agressifs. Cela risque de réduire la performance de la coque de la base. Vous ne devez pas retirer, démonter ou modifier les pièces de la base. Vous ne devez pas graisser ou lubrifier les pièces de la base.

Veuillez lire les consignes de sécurité suivantes

Le siège auto Simplicity de Silver Cross est le seul siège compatible avec la base ISOFIX Simpliflx.

 **N'utilisez jamais la base ISOFIX Simpliflx sur un siège passager équipé d'un airbag. C'est très dangereux et illégal.**

Importante: Guida per la sicurezza

Non utilizzare MAI la base ISOFIX Simplifix Silver Cross su un sedile dotato di airbag frontale. È molto pericoloso e non è contemplato dalla legge.

Accertarsi che la propria vettura sia elencata tra quelle indicate nella lista veicoli idonei fornita insieme alla base.

Quando si utilizza il portabebè Simplicity, indipendente che ci si trovi nella vettura o fuori della vettura, raccomandiamo di far scendere il bambino dal portabebè ad intervalli regolari, specialmente in caso di viaggi di lunga durata. Questa precauzione è importante per alleviare la tensione a livello lombare e alla colonna vertebrale del bambino.

Leggere attentamente l'intera guida delle istruzioni per comprendere pienamente come installare ed utilizzare correttamente la base Simplifix.

Sempre conservare la guida delle istruzioni assieme alla base ISOFIX Simplifix. Si raccomanda di utilizzare il compartimento sulla parte posteriore della base ISOFIX Simplifix per conservare le istruzioni.

Non posizionare alcun oggetto (ad es. asciugamani o cuscini) sotto alla base ISOFIX Simplifix. Potrebbe influire sulle prestazioni della base in caso di incidente.

Non acquistare mai una base di seconda mano.

Sostituire sempre la base ISOFIX Simplifix dopo un incidente. Potrebbe riportare danni non visibili.

Ancorare sempre la base ISOFIX Simplifix ai punti ISOFIX della vettura.

È necessario che tutti gli occupanti della vettura indossino correttamente le cinture di sicurezza in conformità alle leggi vigenti.

Non posizionare alcun oggetto nel vano piedi sulla parte anteriore della base ISOFIX Simplifix.

Altri eventuali oggetti nella vettura dovranno essere fissati correttamente durante il viaggio.

La base ISOFIX Simplifix va coperta se lasciata alla luce diretta del sole. Le superfici metalliche e quelle di plastica possono surriscaldarsi e provocare ustioni.

Non apportare modifiche o alterazioni non autorizzate alla base ISOFIX Simplifix.

Non permettere ad altri bambini di giocare o di cambiare la regolazione della base ISOFIX Simplifix.

Non lasciare il bambino solo nella vettura.

Non appoggiare la base ISOFIX Simplifix su di un tavolo o su un piano di lavoro rialzato, ma posizionarla sempre sul pavimento.

Accertarsi che la base ISOFIX Simplifix non rimanga incastrata

nello sportello della vettura o in un sedile passeggeri ribaltabile.

Accertarsi che tutti i sedili ribaltabili della vettura siano correttamente fissati.

Non collocare la base ISOFIX Simplifix su un sedile auto posizionato lateralmente o in senso opposto rispetto a quello di marcia.

Quando non utilizzata, conservare sempre la base ISOFIX Simplifix in un luogo sicuro e asciutto.

Evitare di conservare la base ISOFIX Simplifix vicino ad una fonte diretta di calore, come ad esempio un termosifone, ed evitare di collocare oggetti pesanti sulla base ISOFIX Simplifix.

AVVERTENZA È possibile che le basi per portabebè lascino segni sulla tappezzeria dei sedili della vettura. Silver Cross non sarà responsabile di eventuali danni o segni presenti sulla tappezzeria dei sedili della vettura. Utilizzare sempre un paio di guide ISOFIX di plastica (in dotazione con la base ISOFIX Simplifix) per evitare di danneggiare la tappezzeria dei sedili della vettura.

 Non posizionare la gamba di supporto anteriore sullo sportello di un vano portaoggetti sul pavimento. La gamba di supporto anteriore DEVE appoggiarsi completamente e stabilmente al pavimento della vettura. Accertarsi che la gamba di

supporto sia ben posizionata e che la base non rimanga rialzata rispetto alla superficie del sedile del veicolo.

 Le basi per portabebè non sono adatte ad ogni tipo di vettura. Per suggerimenti sull'idoneità di questa base per portabebè consultare la lista veicoli idonei fornita insieme alla base prima di acquistare la base stessa e accertarsi che anche la marca, il modello e l'anno di immatricolazione della vettura siano idonei.

Manutenzione della base ISOFIX Simplifix

Per la pulizia utilizzare un sapone delicato per le mani e acqua tiepida. Non utilizzare detersivi, solventi o saponi aggressivi che potrebbero diminuire la resistenza della scocca della base. Non togliere, smontare o alterare nessuna parte della base. Non lubrificare nessuna parte della base.

Leggere le seguenti note per la sicurezza

Il portabebè Simplicity di Silver Cross è l'unico portabebè compatibile con la base ISOFIX Simplifix.

 Non utilizzare mai la base ISOFIX Simplifix su un sedile dotato di airbag frontale. È molto pericoloso e non è contemplato dalla legge.

Importante: Guía de seguridad

Nunca utilice la base ISOFIX Simplifix de Silver Cross en el asiento del copiloto si el vehículo está equipado con airbag frontal. Es sumamente peligroso, además de ser ilegal.

Asegúrese de que su(s) vehículo(s) aparece(n) en la lista de vehículos compatibles proporcionada con la base.

Recomendamos encarecidamente que, cuando se utilice el portabebés Simplicity (ya sea dentro o fuera de un vehículo), se saque al niño a intervalos regulares, sobre todo durante viajes largos. Esto ayudará a aliviar la presión ejercida en la espina dorsal del bebé y en la parte inferior de la espalda.

Lea el manual de instrucciones en su totalidad y asegúrese de entender por completo cómo instalar y utilizar la base Simplifix.

Guarde siempre las instrucciones con la base ISOFIX Simplifix. Se recomienda que se utilice el compartimento situado en la parte trasera del portabebés Simplicity para guardar las instrucciones.

No coloque nada (p. ej. una toalla o un cojín) debajo de la base ISOFIX Simplifix; podría afectar al rendimiento de la base si se produce un accidente.

Nunca compre una base de segunda mano.

Sustituya la base ISOFIX Simplifix por una nueva tras un accidente. Es posible que, aunque no se vea, haya resultado dañada.

Sujete siempre la base ISOFIX Simplifix a los anclajes ISOFIX del vehículo.

Todos los ocupantes del vehículo deben ir debidamente sujetos en conformidad con la ley vigente.

No coloque objetos en el suelo del coche en la zona de la base ISOFIX Simplifix.

Los objetos que pueda haber sueltos por el vehículo deben sujetarse correctamente cuando este se encuentre en movimiento.

Tape la base ISOFIX Simplicity si se va a dejar a la luz solar directa. Las superficies de plástico, así como las metálicas, alcanzan temperaturas elevadas y pueden llegar a quemar.

No realice ninguna modificación ni alteración no autorizadas a la base ISOFIX Simplicity.

No permita que ningún niño juegue o ajuste la base ISOFIX Simplicity.

No deje a los niños solos en el vehículo.

No coloque la base ISOFIX Simplifix en una mesa o superficie elevada; utilice siempre el suelo.

Asegúrese de que la base ISOFIX Simplifix no quede atrapada en la puerta del vehículo ni en los asientos abatibles.

Asegúrese de que todos los asientos abatibles del vehículo se hayan inmovilizado.

No coloque la base ISOFIX Simplifix si el asiento del vehículo mira hacia atrás o hacia el lateral del vehículo.

Guarde siempre la base ISOFIX Simplifix en un lugar seguro y seco cuando no esté en uso.

Evite guardar la base ISOFIX Simplifix cerca de fuentes directas de calor, como radiadores, y no coloque objetos de mucho peso encima.

ADVERTENCIA: Las bases de los portabebés pueden dejar marcas en la tapicería de los vehículos. Silver Cross no se podrá considerar responsable en caso de daño o marcas en los asientos del vehículo. Siempre se debe emplear un par de guías ISOFIX de plástico (incluidas con la base ISOFIX Simplifix) para evitar dañar la tapicería del vehículo.

 No coloque la pata de apoyo delantera sobre la tapa de un compartimento guardaobjetos del suelo del coche. La pata de apoyo delantera DEBE entrar en firme contacto por completo con el suelo del vehículo. Asegúrese de que la pata de apoyo no levante la base de la superficie del asiento del vehículo.

 No toda las bases de los portabebés son compatibles con todos los vehículos. Si necesita ayuda para conocer si esta base de asiento portabebés sirve para su vehículo, consulte la lista de compatibilidad antes de adquirir la base y asegúrese de que la marca, el modelo y el año de su(s) vehículo(s) son compatibles.

Cuidado de su base ISOFIX Simplifix

Pásele un paño con un jabón de mano suave y agua tibia. No debe utilizar detergentes, disolventes ni jabones fuertes. Podría debilitar el armazón de la base. No debe extraer, desmontar ni alterar ninguna de las partes de la base. No debe engrasar ni lubricar ninguna de las partes de la base.

Le rogamos que lea las siguientes notas de seguridad.

El portabebés Simplicity de Silver Cross es el único portabebés compatible con la base ISOFIX Simplifix.

 **NUNCA utilice la base ISOFIX Simplifix en el asiento del copiloto si hay airbag frontal. Es sumamente peligroso, además de ser ilegal.**

重要信息：安全指南

绝不要将 Silver Cross Simplifix ISOFIX 基座安装在配置了前气囊的座椅上。这样做是极度危险并且违反法律的。

请确保您的车型是本基座所含车型适配表中所列车型。

我们强烈建议您在车内外使用 Simplifix 婴儿汽车安全座椅时，定时将宝宝抱出休息，旅途漫长的時候更是如此。这样可以缓解宝宝脊柱及后背下部的压力。

通读使用说明，确保透彻理解 Simplifix 基座的正确安装及使用方法。

Simplifix ISOFIX 基座的使用说明要一直跟产品放在一起。我们建议您把使用说明放在 Simplifix 婴儿汽车安全座椅后面的储物格里。

Simplifix ISOFIX 基座下面不要放类似毛巾或坐垫之类的东西。在交通事故发生的时候这些东西可能影响基座的保护性能。

不要购买二手基座。

交通事故过后要更换 Simplifix ISOFIX 基座。基座受损可能难以察觉。

要确保 Simplifix ISOFIX 基座与汽车座椅上的 ISOFIX 接点连接牢固。

车内所有乘客都必须按照现行法律正确使用安全防护装置。

在 Simplifix ISOFIX 基座前方的腿部空间处不要放置任何物品。

在行车过程中需将零散物品放好。

如果有直接日晒需将 Simplifix ISOFIX 基座盖好。塑料、金属表面可能会变热甚至燃烧。

未经授权不可擅自改装 Simplifix ISOFIX 基座。

不要让宝宝摆弄或调节 Simplifix ISOFIX 基座。

不要把宝宝自己留在车里。

不要把 Simplifix ISOFIX 基座放在桌子上或其他操作台上，只能放在地上。

不要让车门、可调节车座靠背把 Simplifix ISOFIX 基座夹住。

要将所有的可调节车座靠背牢固锁定。

不要把 Simplifix ISOFIX 基座安装在朝向车辆侧面或后方的座椅上。

在不使用 Simplifix ISOFIX 基座时，要找安全、干爽的地方把座椅放好。

不要把 Simplifix ISOFIX 基座存放在直接热源附近，比如不要放在暖气周围，也不要安全座椅上放置重物。

警告：婴儿汽车安全座椅基座可能会给您的车座皮饰带来磨损。对于此类车座损坏或磨损，Silver Cross 恕不负责任。要使用随 Simplifix ISOFIX 基座提供的一对塑料制导架，以避免损坏您的汽车座椅皮饰。

 不要把前段支架放置在储物盒盖上一一定要把前段支架牢牢地放在车厢地板上。要确保支架不会提高汽车座椅的水平面。

 并非所有的婴儿安全座椅基座都适用于所有车型。如果需要 Simpliflix ISOFIX 基座适配性方面的建议, 请在购买基座前核对车型适配表并确保汽车品牌, 型号, 车辆制造年份等都合适。

Simpliflix ISOFIX 基座的护理

用温性的洗手液和温水擦拭。不可使用消毒液、溶剂或强力皂液。这可能会使基座外表的强度减弱。绝不可以移动、拆除或改动基座的任何部分。绝不可以给基座任何部分上机油或润滑剂。

请阅读以下安全说明

Silver Cross Simplicity 婴儿汽车安全座椅是与 Simpliflix ISOFIX 底座配套使用的唯一产品。

 绝不要在装配了前安全气囊的座位上使用 Simpliflix ISOFIX 底座。这样做是极度危险并且违反法律的。

Важно: Инструкция по безопасности

Никогда не устанавливайте базу по ставку для автокресла Silver Cross Simplifix ISOFIX на пассажирском сиденье с фронтальной подушкой безопасности. Это очень опасно и является нарушением закона.

Убедитесь, что ваш автомобиль указан в списке одобренных автомобилей, который предоставляется вместе с подставкой.

При использовании детского автокресла Simplicity в машине либо вне ее настоятельно рекомендуется регулярно вынимать ребенка, особенно при длительных поездках. Это облегчит нагрузку на позвоночник и поясницу ребенка.

Прочтите инструкцию целиком и убедитесь, что полностью понимаете как правильно установить и использовать подставку Simplifix.

Всегда держите инструкцию вместе с подставкой Simplifix ISOFIX. Хранить инструкцию рекомендуется в отсеке в задней части автокресла Simplicity.

Не подкладывайте под подставку Simplifix ISOFIX посторонние предметы, например, полотенце или подушку. Это может повлиять на рабочие характеристики подставки в случае аварии.

Никогда не покупайте подержанную подставку.

Всегда заменяйте подставку Simplifix ISOFIX после аварии. Подставка может иметь скрытые повреждения.

Всегда закрепляйте подставку Simplifix ISOFIX в точках крепления ISOFIX автомобиля.

Все пассажиры должны быть пристегнуты ремнями безопасности согласно действующему законодательству.

Не кладите посторонние предметы на пол перед подставкой Simplifix ISOFIX.

Незакрепленные предметы должны быть зафиксированы перед началом движения автомобиля.

Накройте подставку Simplifix ISOFIX, если оставляете ее под прямыми солнечными лучами. Пластиковые и металлические поверхности сильно нагреваются и могут причинить ожоги.

Не вносите непредусмотренные изменения в конструкцию подставки Simplifix ISOFIX.

Не позволяйте детям играть с подставкой Simplifix ISOFIX или регулировать ее.

Не оставляйте детей одних в автомобиле.

Не помещайте подставку Simplifix ISOFIX на стол, ставьте ее только на пол.

Убедитесь, что подставка Simplifix ISOFIX не будет зажата дверью автомобиля или складывающимся пассажирским сиденьем.

Убедитесь, что все складные автомобильные сиденья надежно закреплены.

Не устанавливайте подставку Simplifix ISOFIX на сиденье, повернутое вбок или

направленное против хода движения автомобиля.

Всегда храните подставку Simplifix ISOFIX в безопасном, сухом месте, когда она не используется.

Не храните подставку Simplifix ISOFIX рядом с источником тепла, таким как отопительная батарея, и не кладите на подставку тяжести.

ВНИМАНИЕ! Подставки для детских автокресел могут повредить обивку автомобильного сиденья. Компания Silver Cross не может нести ответственности за повреждение или загрязнение автомобильных сидений. Во избежание повреждения обивки автомобильного сиденья всегда используйте пару пластиковых направляющих ISOFIX (поставляются вместе с подставкой Simplifix ISOFIX).

 Не устанавливайте переднюю опору на наполную крышку багажного отсека. Передняя опора ДОЛЖНА быть надежно зафиксирована на полу автомобиля. Убедитесь, что опора не отрывает подставку от поверхности автомобильного сиденья.

 Не все подставки для детских автокресел подходят к любым автомобилям. Чтобы узнать, подходит ли эта подставка, проверьте список одобренных автомобилей перед покупкой подставки и убедитесь, что марка, модель и год выпуска вашего автомобиля указаны в списке.

Уход за подставкой Simplifix ISOFIX

Протрите начисто, используя слабощелочное мыло для рук и теплую воду. Запрещено использовать моющие средства, растворители или сильнощелочное мыло. Это может привести к снижению прочности материалов подставки. Запрещено снимать, разбирать или вносить изменения в какие-либо узлы конструкции подставки. Запрещено смазывать детали подставки.

Прочтите следующие комментарии по безопасности

Автокресло Silver Cross Simplicity является единственным детским автокреслом, совместимым с подставкой Simplifix ISOFIX.

 **ЗАПРЕЩЕНО** устанавливать подставку Simplifix ISOFIX на пассажирском сиденье с фронтальной подушкой безопасности. Это очень опасно и является нарушением закона.

Notes:

Notes:

Silver Cross®

THE BEST START IN LIFE

SEMI
UNIVERSAL
<0-13kg



XX.XX.XXXX



Silver Cross (UK) Ltd, Micklethorn, Broughton, Skipton, North Yorkshire, BD23 3JA

silvercrossbaby.com

SXSIMPLIFIX-BASE-062016