

Zombie-Knight Storage Small

Compatible with Zombicide: Green Horde /
Zombicide: Black Plague

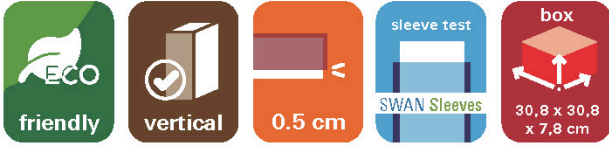

This product is not licensed, and is up for change at any time in the future.



Assembly Guide

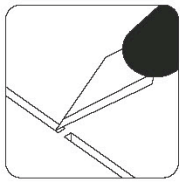

Use an exacto knife to cut the bits connecting the parts to the frame.

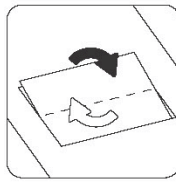

Remove the parts from the frame with a rotating motion along the axis formed by the bits you just cut.

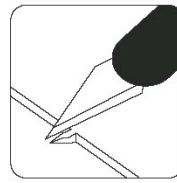

Use the exacto knife to remove any of the remaining connection bits.

Use **wood glue** for assembly. Always dry fit the parts first to make sure the components are correct ones. If you encounter any issues, please contact us at info@laserox.net or our Facebook page at facebook.com/laseroxinserts.

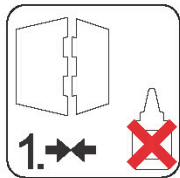

Always dry-fit the parts to together without any glue to make sure you are assembling the correct parts.

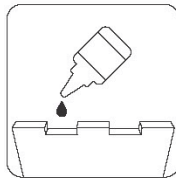

Use a drop of glue along the joints and hold it in place until the glue has sufficiently dried.

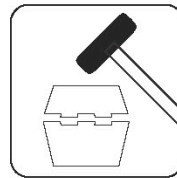

Press the parts together or use a hobby hammer with slight force for assembly.



14+ WARNING Choking hazard!
Not for children under 14 years.

Part numbers

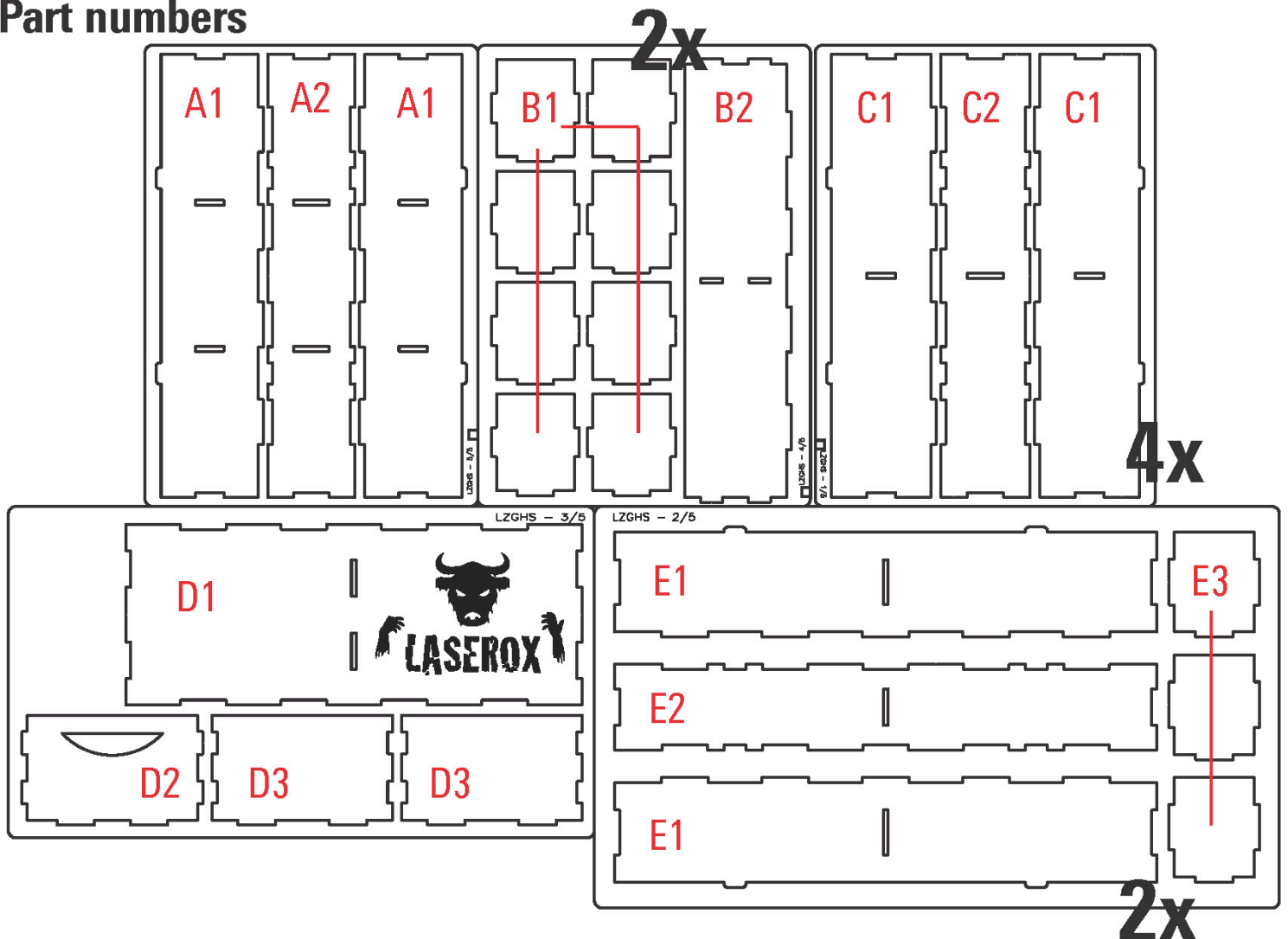

Long miniature tray

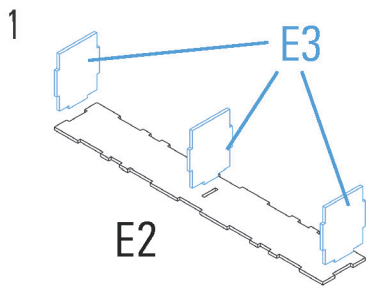

Required parts: **E1x4,E2x2,E3x6**

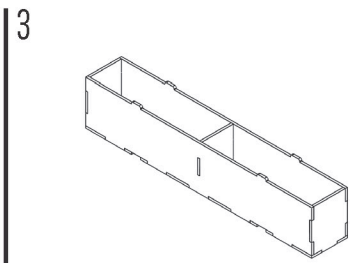
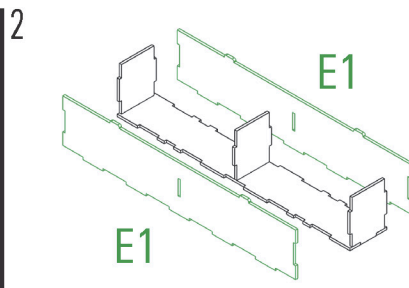

Assemble 2x

Short miniature tray

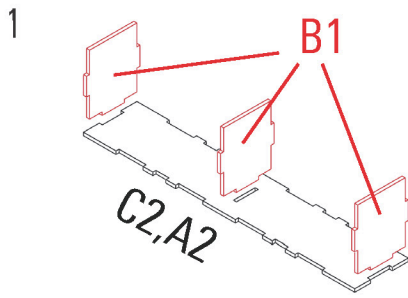

Required parts: **A1x2,A2,B1x16,C1x8,C2x4**

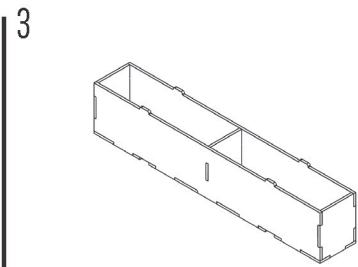
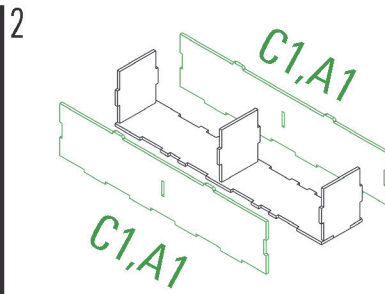

Assemble 5x

Wide miniature tray

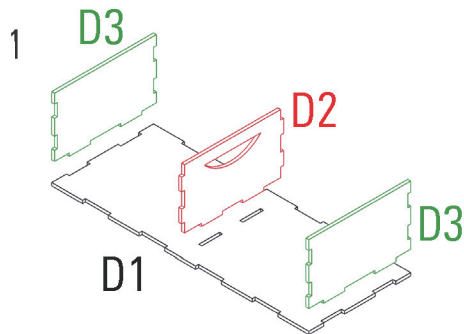

Required parts: **B2x2,D1,D2,D3x2**

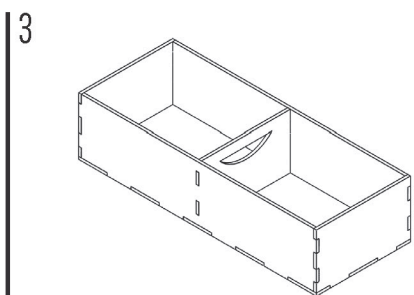
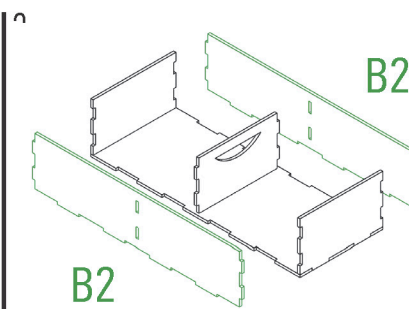

Assembly

