

Sleeping Gods Organizer

Compatible with Sleeping Gods and Sleeping Gods: Tides of Ruin

This box organizer is compatible with Sleeping Gods and Sleeping Gods: Tides of Ruin Expansion. This product is not licensed, and is up for change at any time in the future.

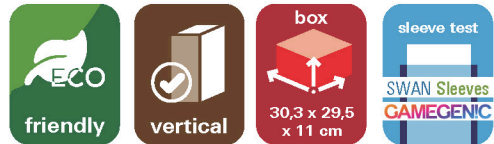

Assembly Guide



Watch our beginners guide videos on youtube. Just scan the QR code and get started!

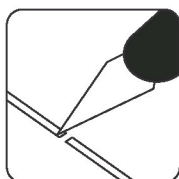

Use an exacto knife to cut the bits connecting the parts to the frame.

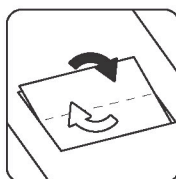

Remove the parts from the frame with a rotating motion along the axis formed by the bits you just cut.

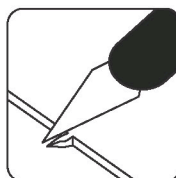

Use the exacto knife to remove any of the remaining connection bits.

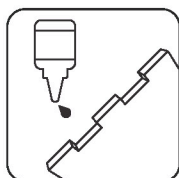

Most joints are press-fit, but some joints might require a drop of glue to ensure a strong bond.

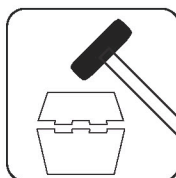

Press the parts together or use a hobby hammer with slight force for assembly.



LASEROX

Use **wood glue** for assembly. If you encounter any issues, please contact us at info@laserox.net



WARNING: Not a toy. Not suitable for children under 14 years of age.

Box Assembly

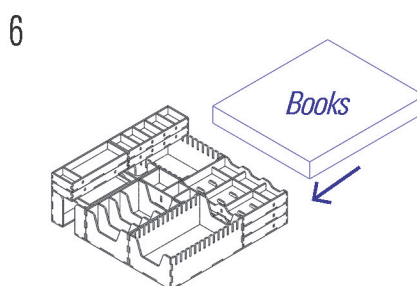
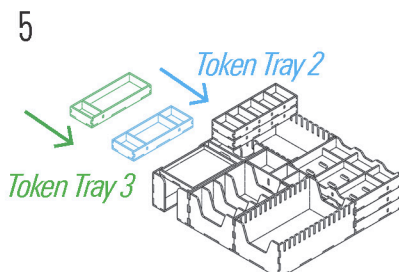
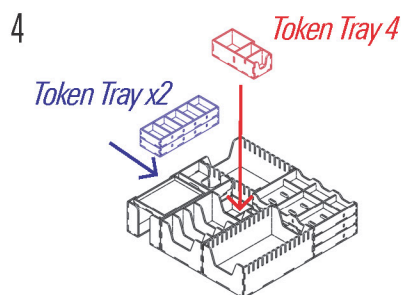
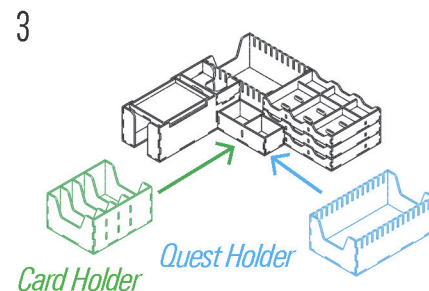
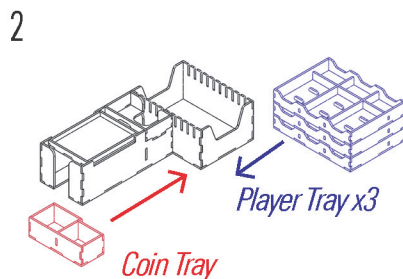
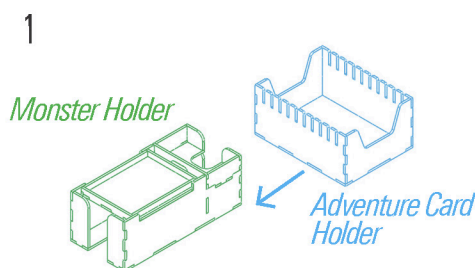

Share your creation!



#laseroxinserts

Watch our "How it fits" video and get your game organized!



<http://tiny.cc/lsrslg>

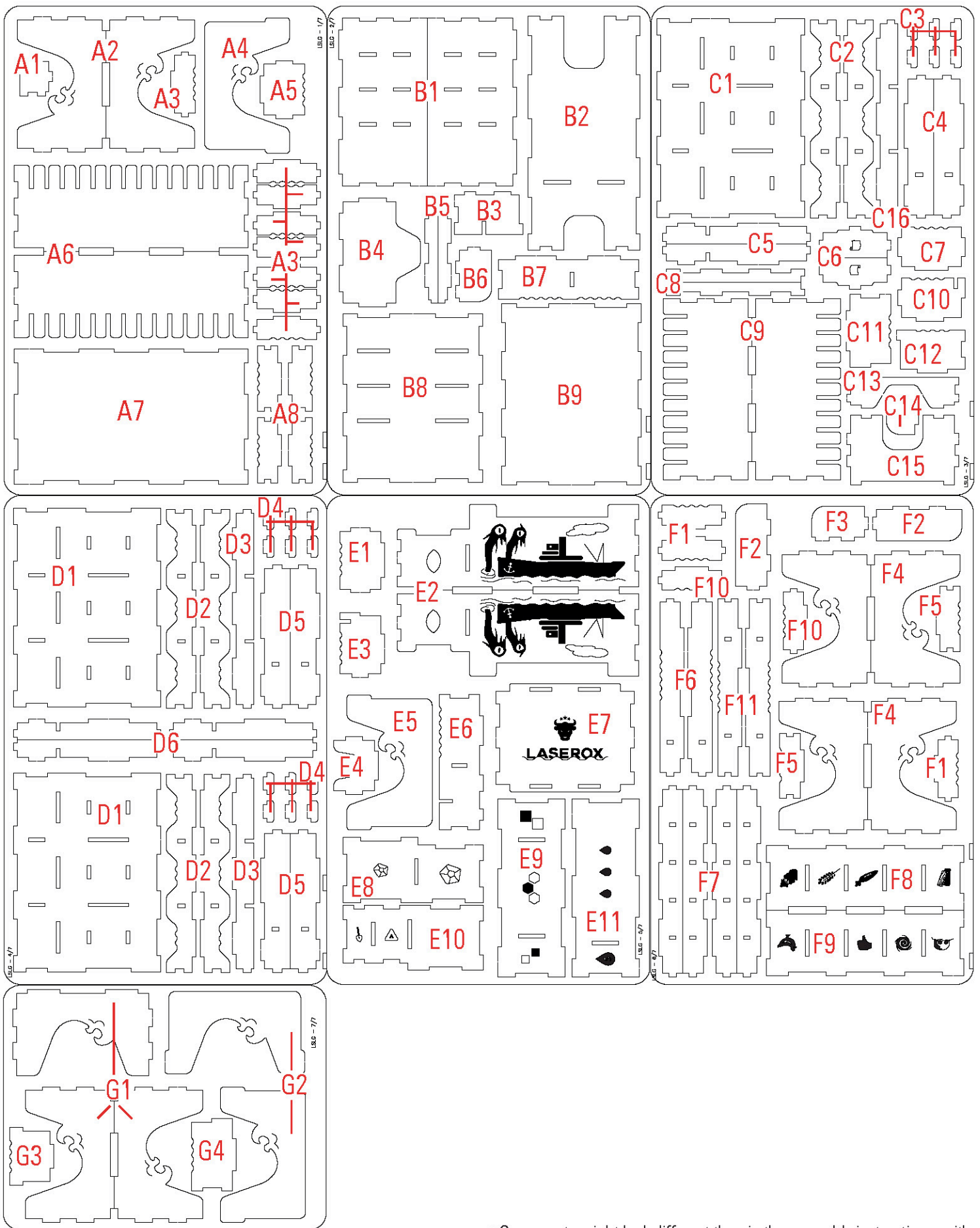

- Some parts might look different than in the assembly instructions, with added decorations/engravings/embellishments.
- Color variations or branch marks are a natural part of the birch plywood.
- The burnt smell of wood is natural and will dissipate with time.
- Rarely the laser will not cut through the complete sheet, but this can be fixed with the help of a hobby knife. If that is not possible, please contact us for a replacement!

Adventure Card Holder

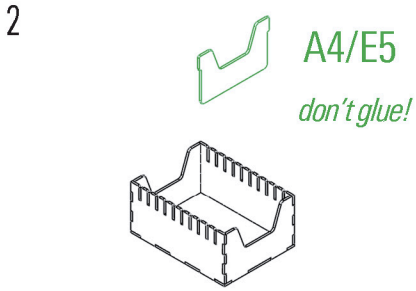
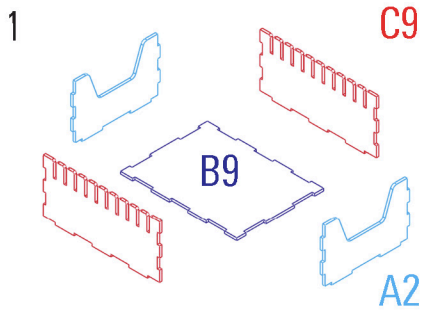

Required parts: **A2**x2, **B9**, **C9**x2, **A4**, **E5**

Card Holder

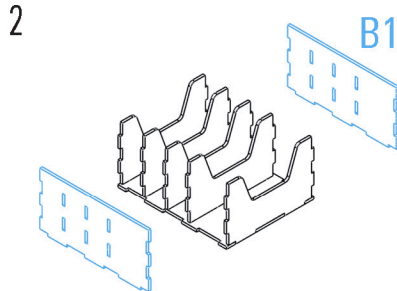
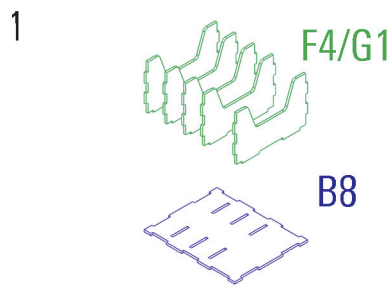

Required parts: **B8**, **F4**x4, **G1**, **B1**x2

Quest Holder

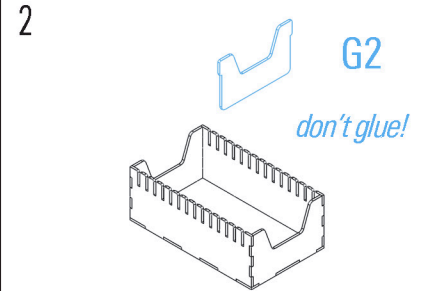
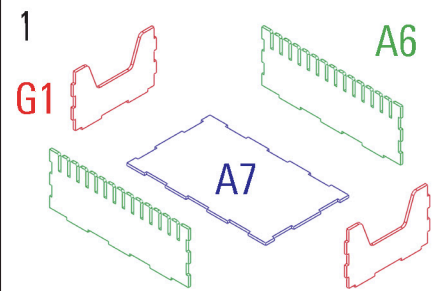

Required parts: **A6**x2, **A7**, **G1**x2, **G2**x2

Coin Tray

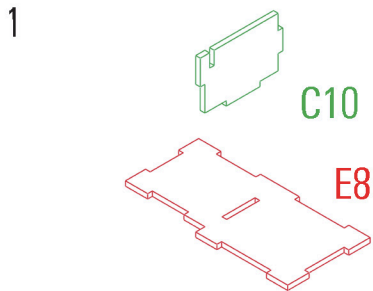

Required parts: **C10**, **E8**, **B7**, **C12**, **A5**, **C7**, **C11**

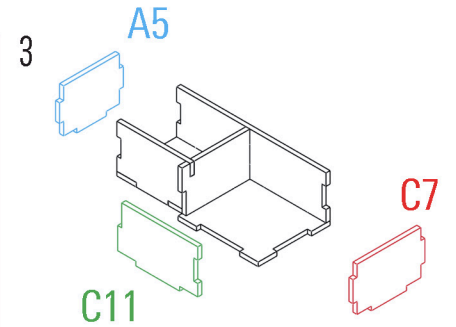
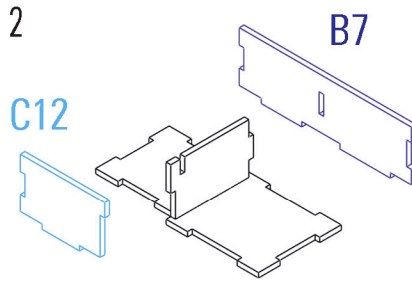

Token Tray

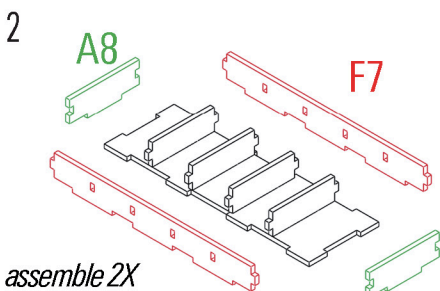
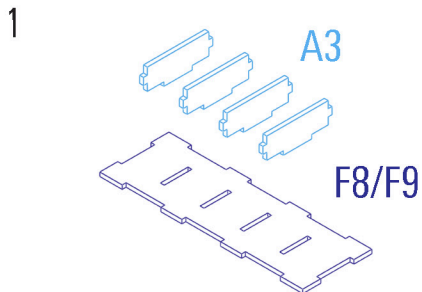

assemble 2X

Required parts: **A3**x4, **F8**, **F9/A8**, **F7**x2

Token Tray 2

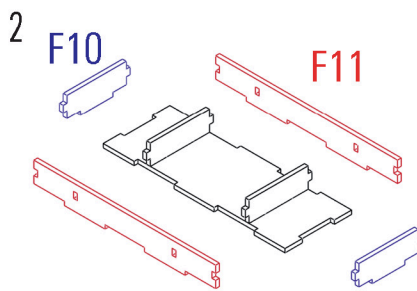
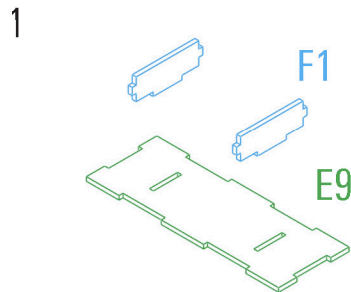

Required parts: **E9**, **F1**x2, **F10**x2, **F11**x2

Token Tray 3

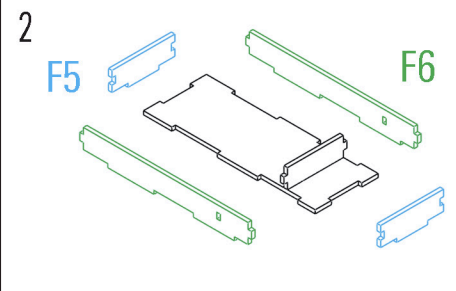
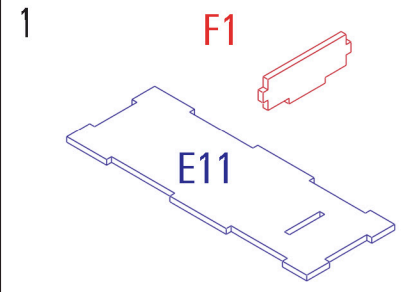

Required parts: **E11**, **F1**, **F5**x2, **F6**x2

Player Tray

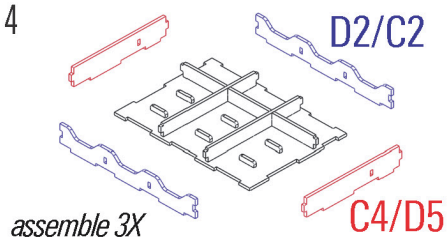
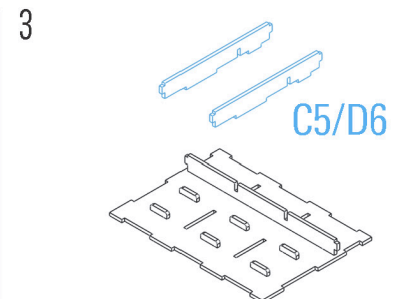
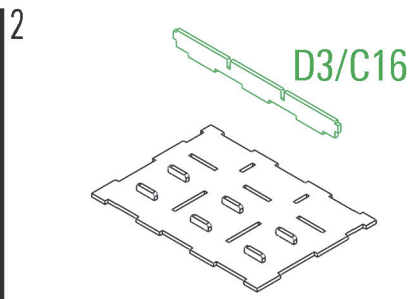
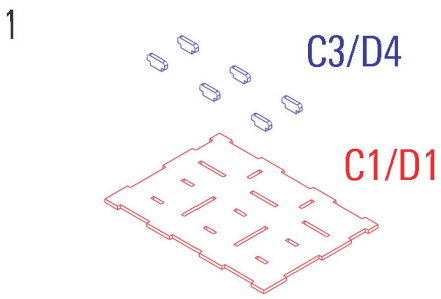

assemble 3X

Required parts: **C3**x6, **D4**x12, **C1**, **D1**x2, **D3**x2, **C16**, **C5**x2, **D6**x4, **C2**x2, **C4**x2, **D2**x4, **D5**x4

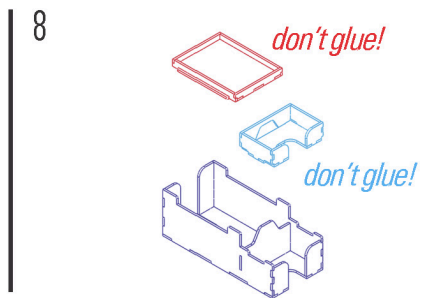
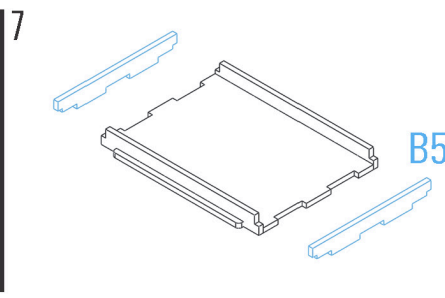
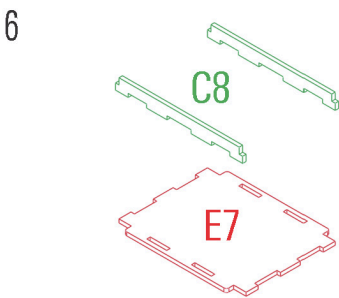
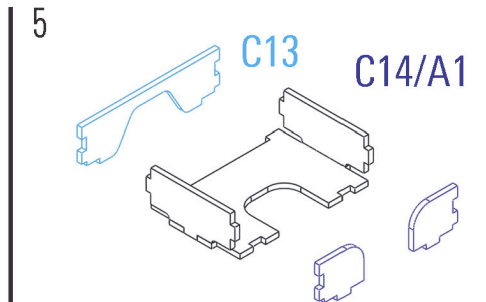
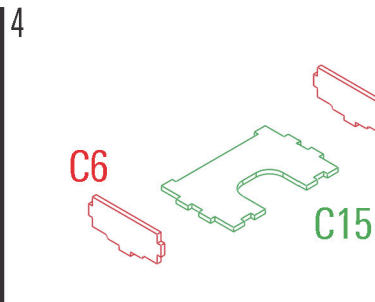
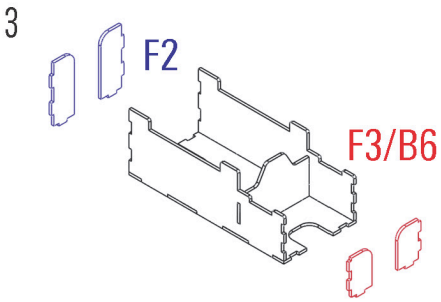
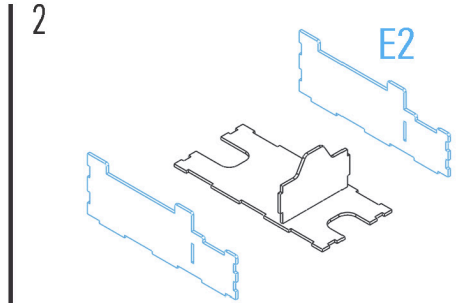
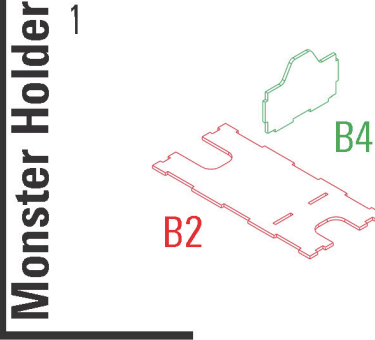

Required parts: **B2**, **B4**, **E2**x2, **B6**, **F2**x2, **F3**, **C6**x2, **C15**, **A1**, **C13**, **C14**, **C8**x2, **E7**, **B5**x2

Token Tray 4

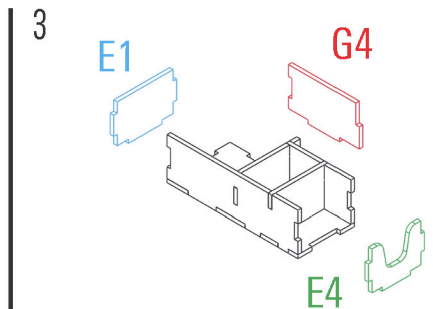
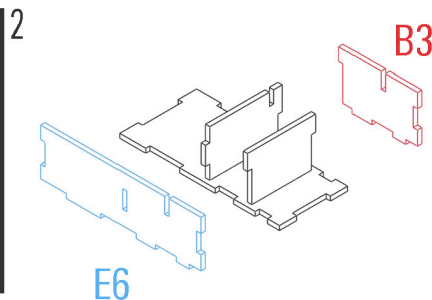
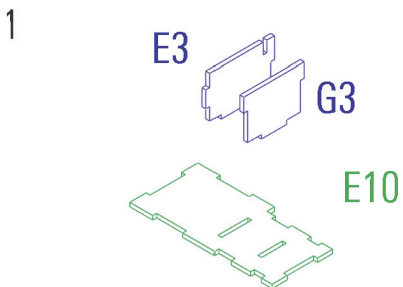

Required parts: **E3**, **E10**, **G3**, **B3**, **E6**, **E1**, **E4**, **G4**