

# Stardust Storage

Compatible with Roll for the Galaxy®

and the following expansion: Roll for the Galaxy: Ambition.

This product is not licensed, and is up for change at any time in the future.



## Assembly Guide

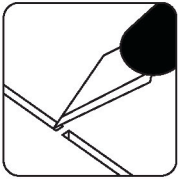

Use an exacto knife to cut the bits connecting the parts to the frame.

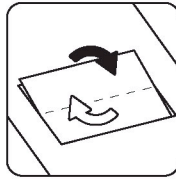

Remove the parts from the frame with a rotating motion along the axis formed by the bits you just cut.

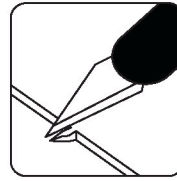

Use the exacto knife to remove any of the remaining connection bits.

Use **wood glue** for assembly. Always dry fit the parts first to make sure the components are correct ones. If you encounter any issues, please contact us at [info@laserox.net](mailto:info@laserox.net) or our Facebook page at [facebook.com/laseroxinserts](https://facebook.com/laseroxinserts).

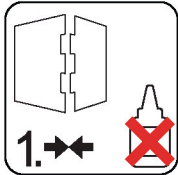

Always dry-fit the parts to together without any glue to make sure you are assembling the correct parts.

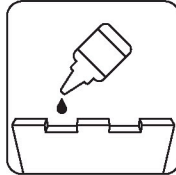

Use a drop of glue along the joints and hold it in place until the glue has sufficiently dried.

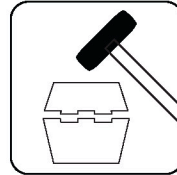

Press the parts together or use a hobby hammer with slight force for assembly.



**14+** WARNING Choking hazard! Not for children under 14 years.

## Part numbers

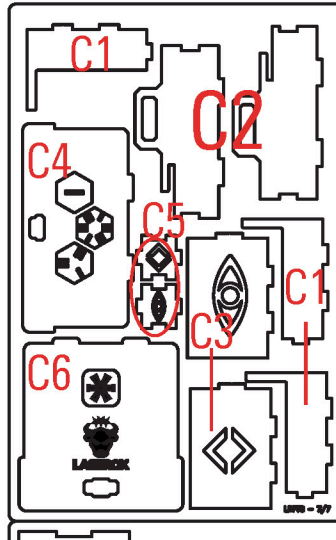
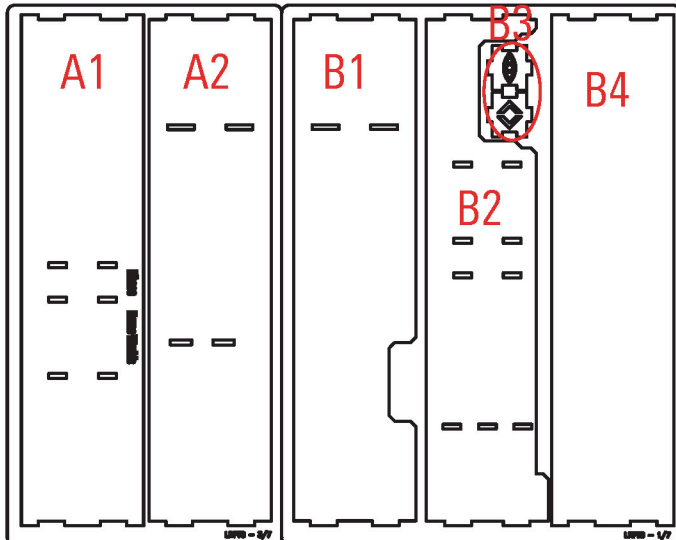

**B3, C5, D4, G7** - These parts should be used to build a small first player marker rocket and the cube is the Dice of Glory which the winner of the game will receive.

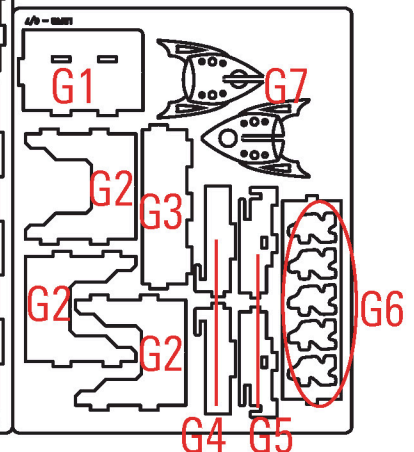
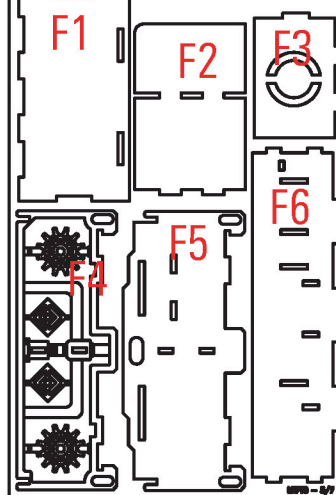
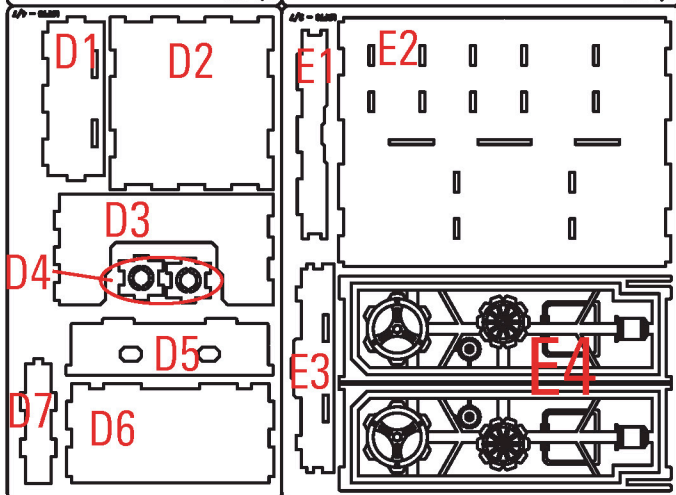
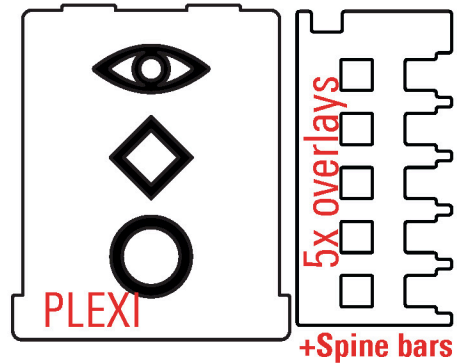

# Coins

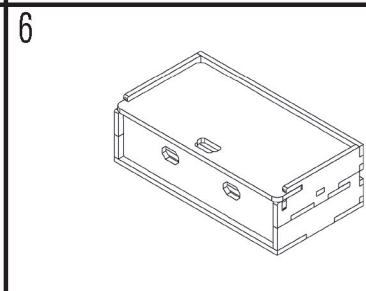
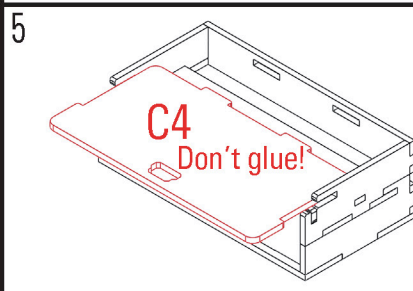
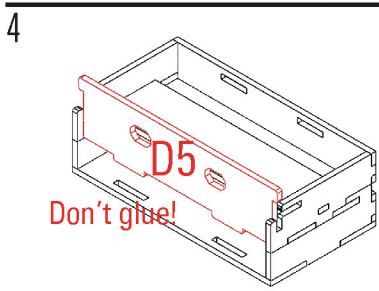
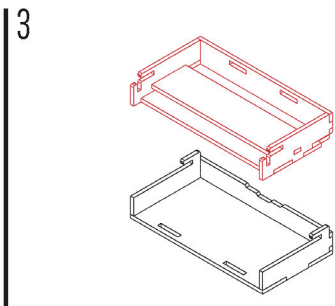
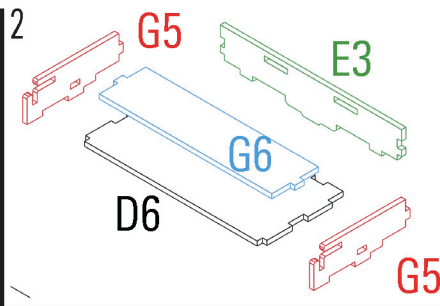
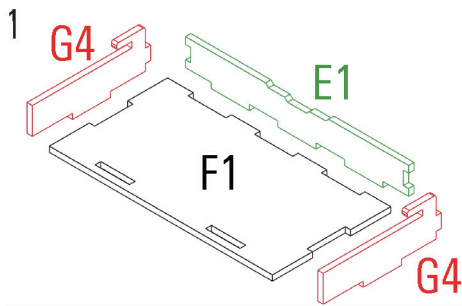

Required parts: **C4,D5,D6,E1,E3,F1,G4x2,G5x2,G6**

# Dice box

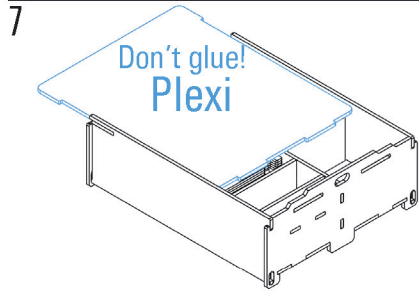
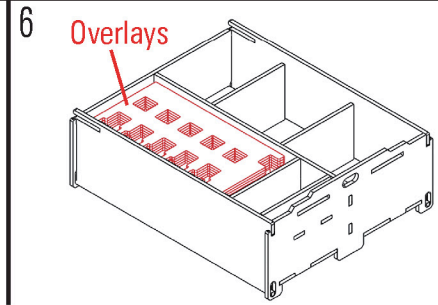
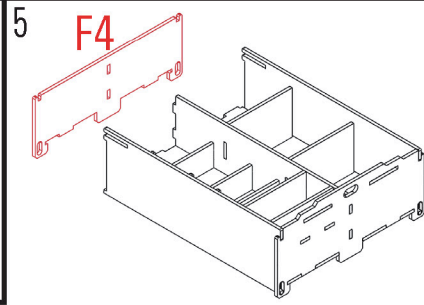
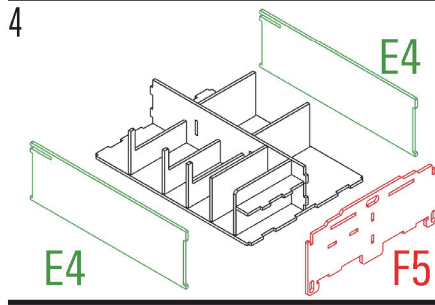
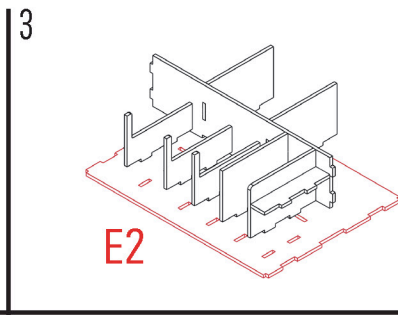
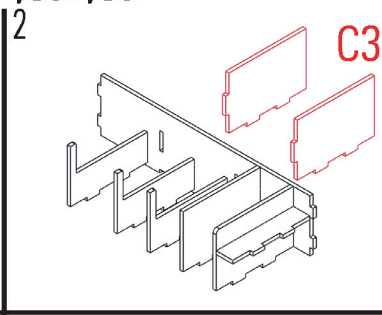
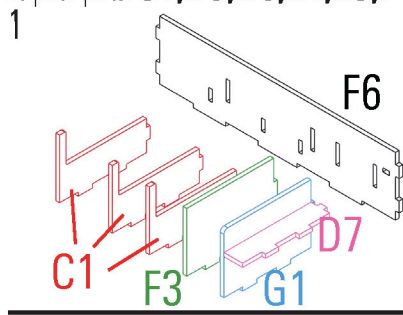

Required parts: **C1x3,C3x2,D7,E2,E4x2,F3,F4,F5,F6,G1,plexi,overlays**

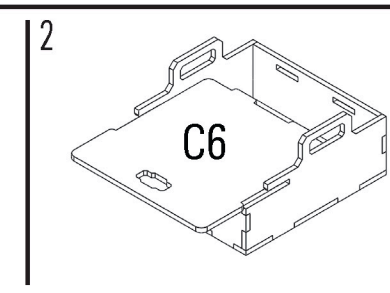
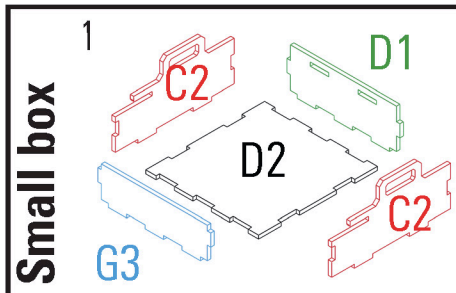

Required parts: **C2x2,C6,D1,D2,G3**

# Assembly

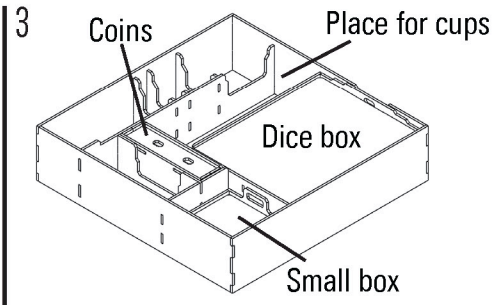
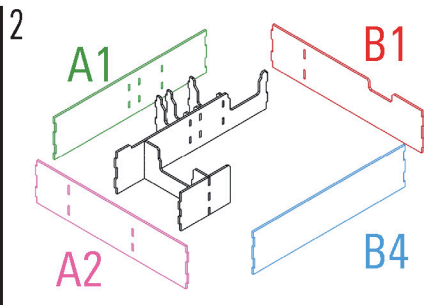
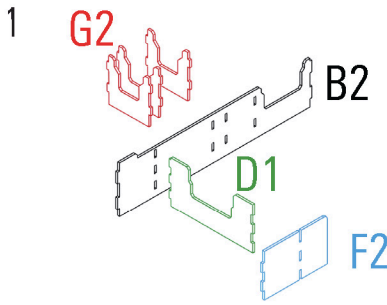

Required parts: **A1,A2,B1,B2,B4,D3,F2,G2x2,**