

FrostBox - Tuckbox

LFHV-MT

Compatible with Frosthaven Organizer

This box organizer is compatible our Frosthaven organizer. This product is licensed by Cephalofair, and is up for change at any time in the future.



Assembly Guide



Watch our beginners guide videos on youtube. Just scan the QR code and get started!

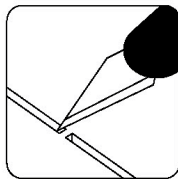

Use an exacto knife to cut the bits connecting the parts to the frame.

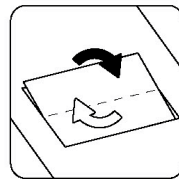

Remove the parts from the frame with a rotating motion along the axis formed by the bits you just cut.

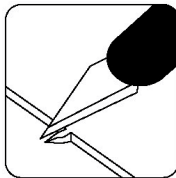

Use the exacto knife to remove any of the remaining connection bits.

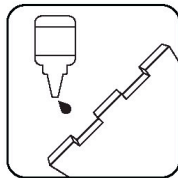

Most joints are press-fit, but some joints might require a drop of glue to ensure a strong bond.

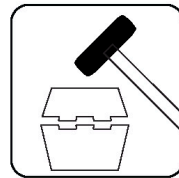

Press the parts together or use a hobby hammer with slight force for assembly.



LASEROX

Use **wood glue** for assembly. If you encounter any issues, please contact us at info@laserox.net



WARNING: Not a toy. Not suitable for children under 14 years of age.

Monster Storage

T.B. 1/3 (x2)

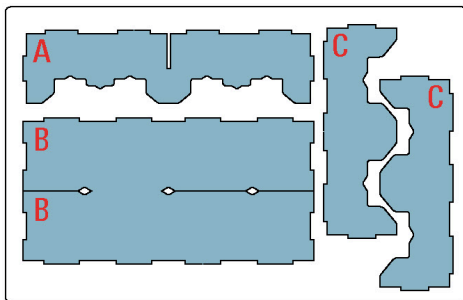

T.B. 2/3 (x2)

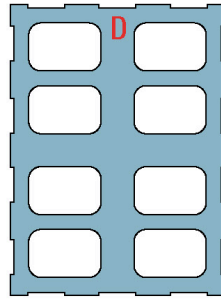

T.B. 3/3

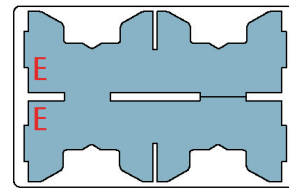

1

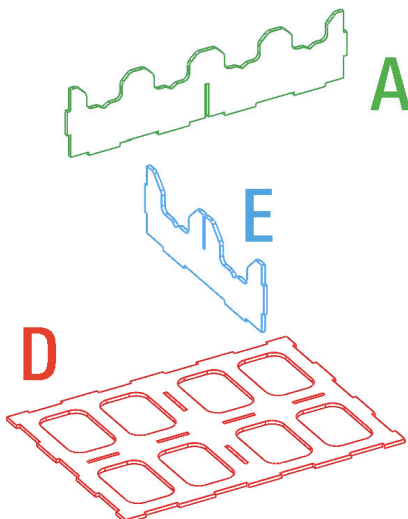

2

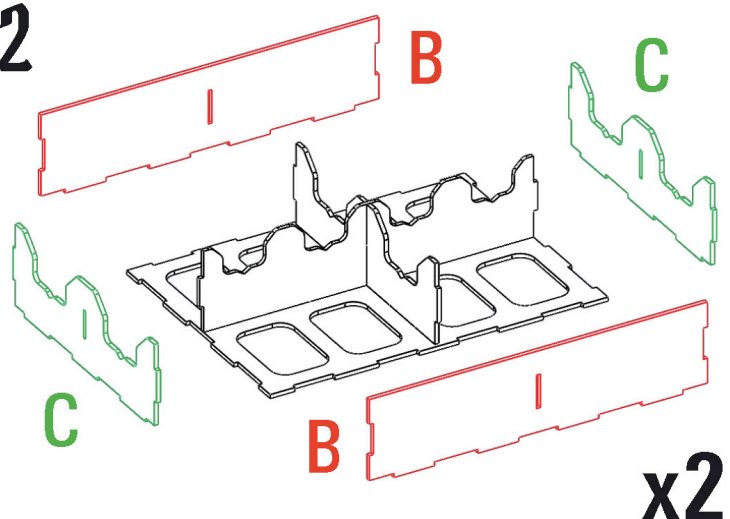



Tray 1



Abael Herder

Algox Archer

Algox Icespeaker

Algox Snowspeaker

Ancient Artillery

Burrowing Blade

Chaos Demon

Frost Demon

Guards

Harrower Infester

Hound

Ice Wraith

Deep Terror

Earth Demon

**Flaming
Bladespinner**

Frozen Corpse

Flame Demon

Living Bones

Living Doom

Living Spirit

Imps



Tray 2



Lightning Eel

Lurker Clawcrusher

Lurker Wavethrower

Lurker Mindsnipper

Lurker Soldier

Night Demon

Robotic Boltshooter

Ruined Machine

Savvas Icestorm

Scouts

Ooze

Piranha Pig

Polar Bear

Priests

Rending Drake

Shrike Fiend

Savvas Lavaflow

Sun Demon

Spitting Drake

Steel Automaton

Wind Demon