

# Dwarven Mine

Compatible with Caverna  
& Caverna: The Forgotten Folk®

This box organizer is compatible with Caverna®  
This product is officially licensed by Lookout Games and is up for change at any time in the future.

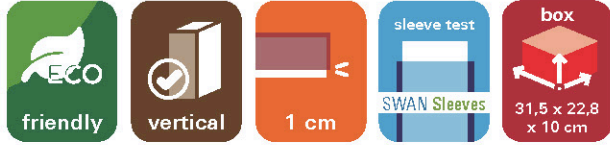

## Assembly Guide

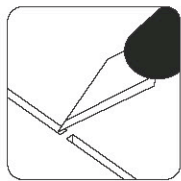

Use an exacto knife to cut the bits connecting the parts to the frame.

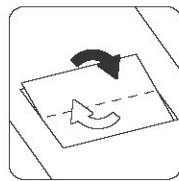

Remove the parts from the frame with a rotating motion along the axis formed by the bits you just cut.

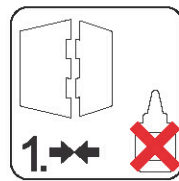

Always dry-fit the parts to together without any glue to make sure you are assembling the correct parts.

Use **wood glue** for assembly. Always dry fit the parts first to make sure the components are correct ones. If you encounter any issues, please contact us at [info@laserox.net](mailto:info@laserox.net) or our Facebook page at [facebook.com/laseroxinserts](https://facebook.com/laseroxinserts).

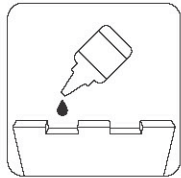

Use a drop of glue along the joints and hold it in place until the glue has sufficiently dried.

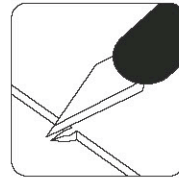

Use the exacto knife to remove any of the remaining connection bits.

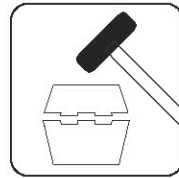

Press the parts together or use a hobby hammer with slight force for assembly.



**14+** WARNING Choking hazard! Not for children under 14 years.

## Part numbers

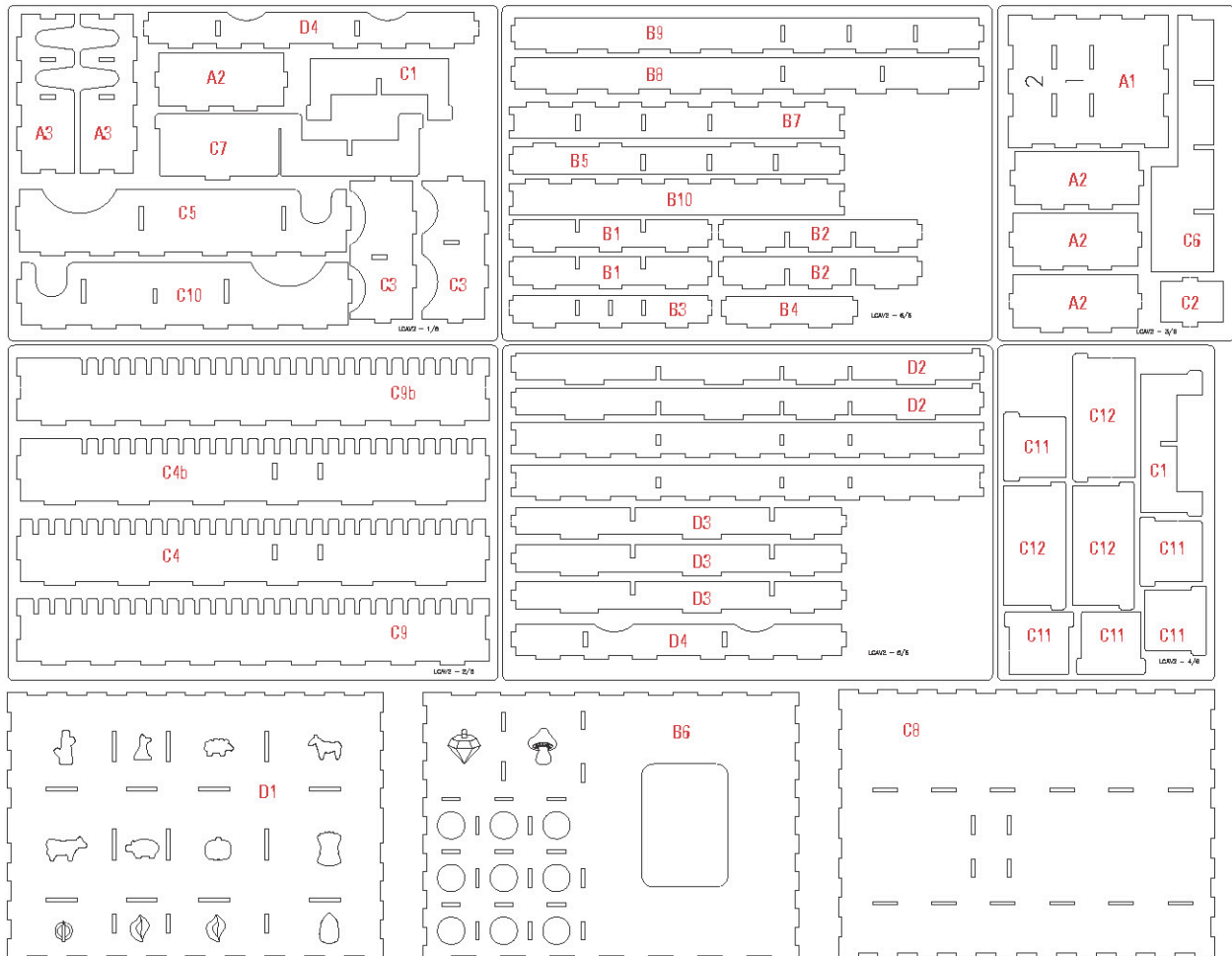

### Part 1. Coins

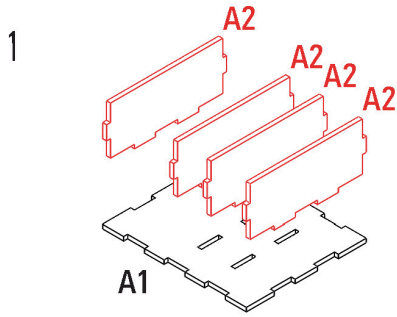

Required parts: **A1, A2x4, A3x2**

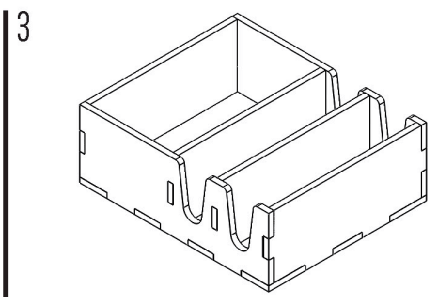
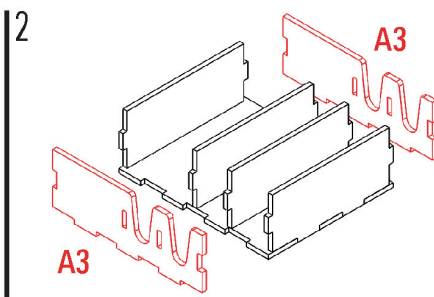

### Part 2. Expansion tray

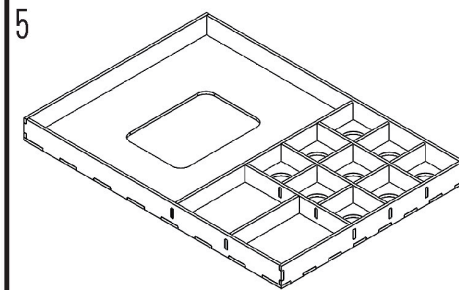
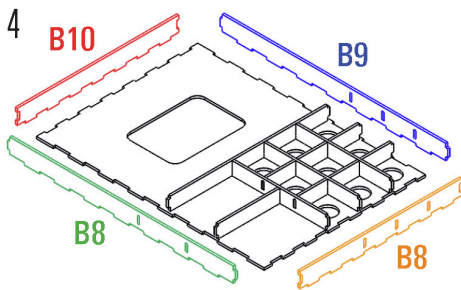
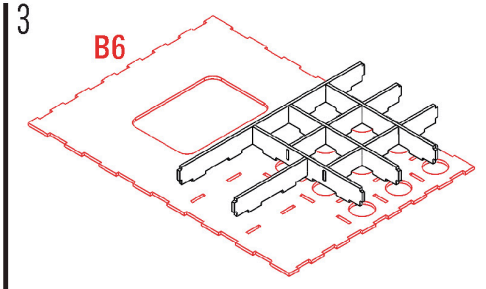
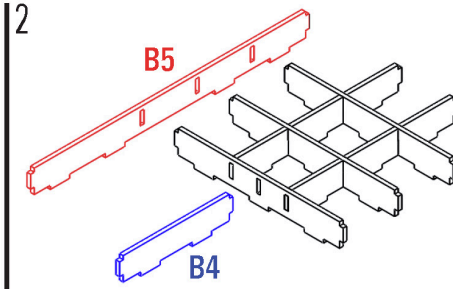
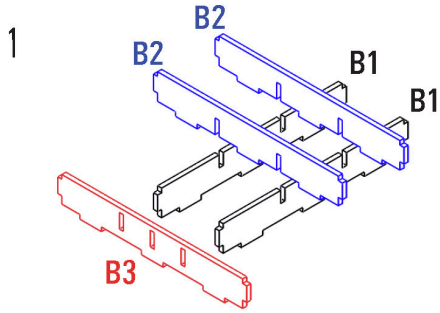

Required parts: **B1x2, B2x2, B3, B4, B5, B6, B7, B8, B9, B10**

### Part 3. Cardboard tray

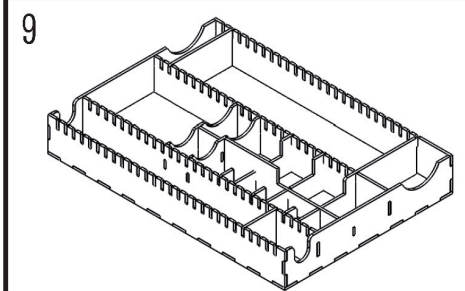
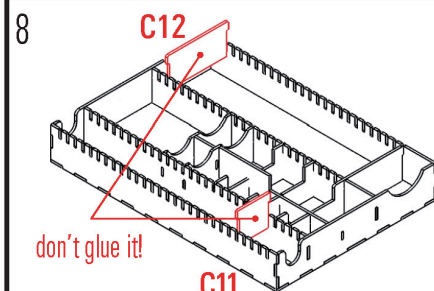
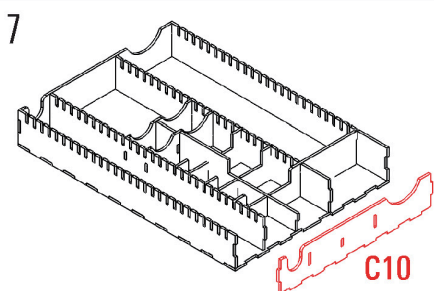
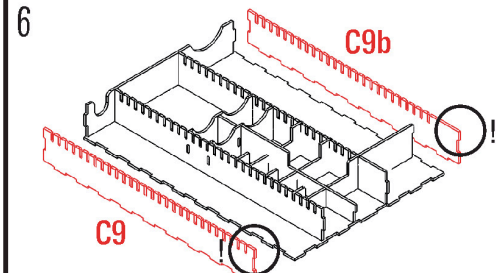
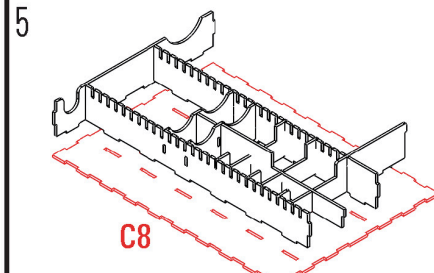
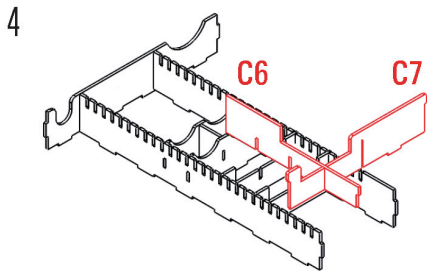
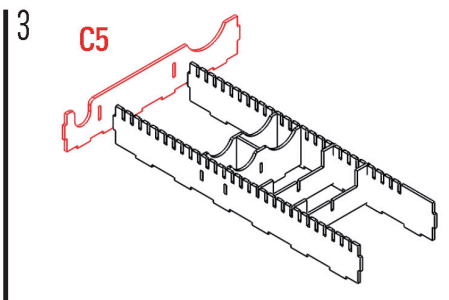
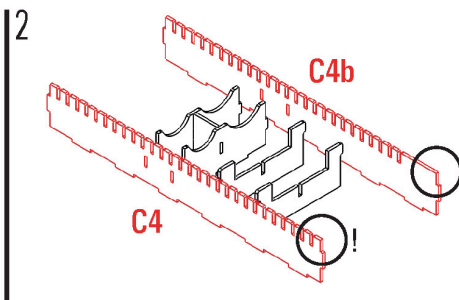
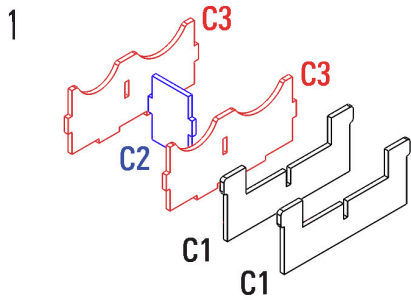

Required parts: **C1x2, C2, C3x2, C4, C4b, C5, C6, C7, C8, C9, C9b, C10, C11x5 (optional), C12x3 (optional)**

# Assembly

# Part 4. Resource tray

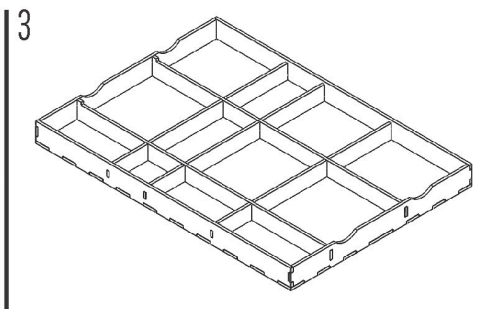
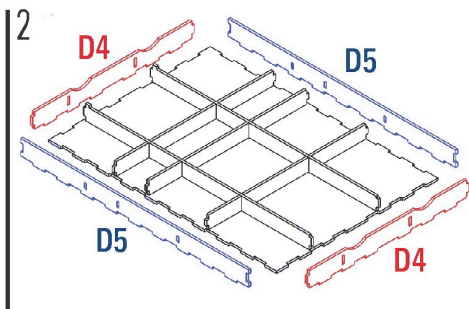
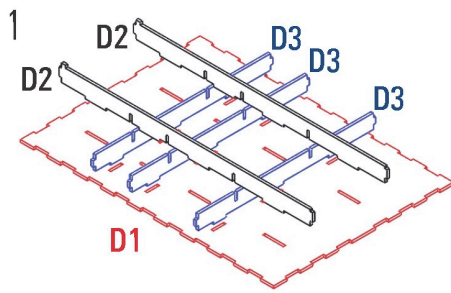
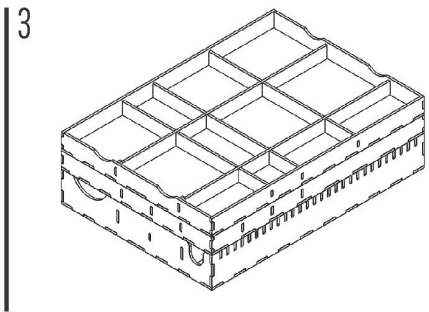
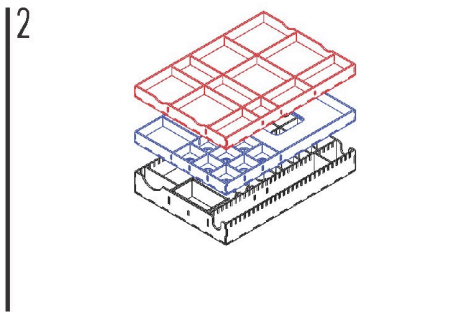
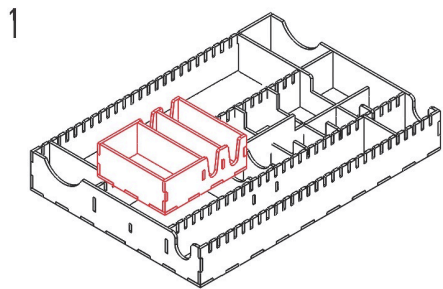

Required parts: **T1**, **B2x2**, **B4x2**, **PX3**



We would like to extend our offer to you:

