

Aeon Trespass: Odyssey

LATO

Compatible with Aeon Trespass: Odyssey

This box organizer is compatible with Aeon Trespass: Odyssey.
This product is not licensed and is up for change at any time in the future.



Assembly Guide



Watch our beginners guide videos on youtube. Just scan the QR code and get started!

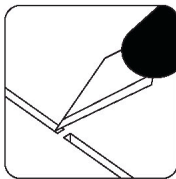

Use an exacto knife to cut the bits connecting the parts to the frame.

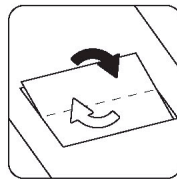

Remove the parts from the frame with a rotating motion along the axis formed by the bits you just cut.



LASEROX

Use **wood glue** for assembly. If you encounter any issues, please contact us at info@laserox.net

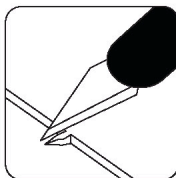

Use the exacto knife to remove any of the remaining connection bits.

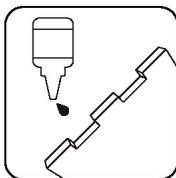

Most joints are press-fit, but some joints might require a drop of glue to ensure a strong bond.

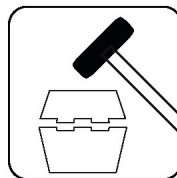

Press the parts together or use a hobby hammer with slight force for assembly.



WARNING: Not a toy. Not suitable for children under 14 years of age.

Box Assembly

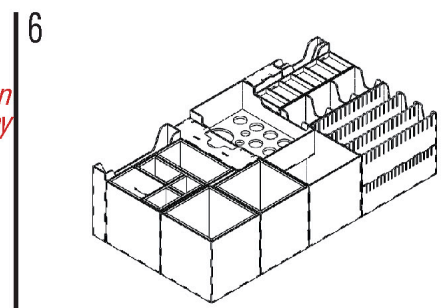
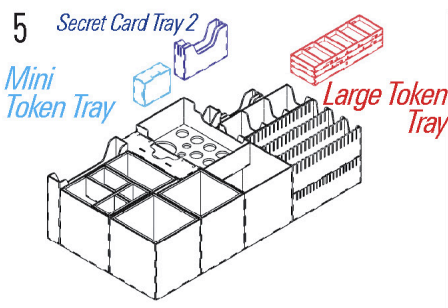
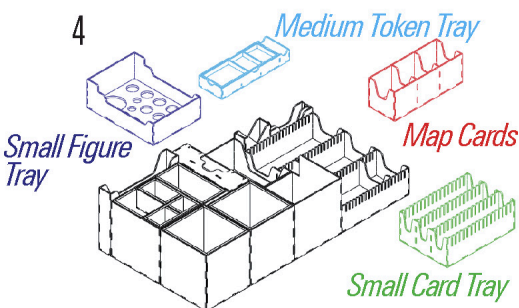
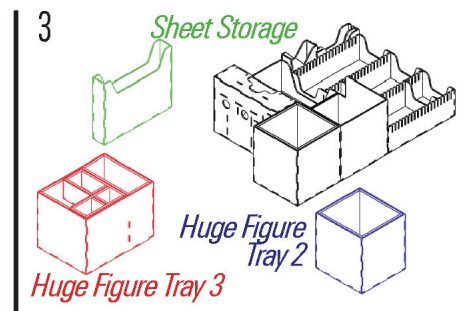
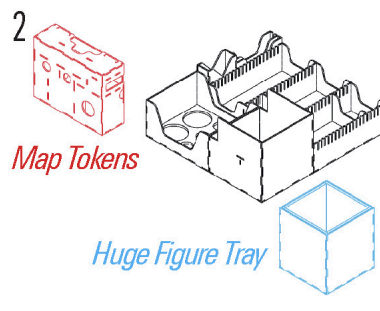
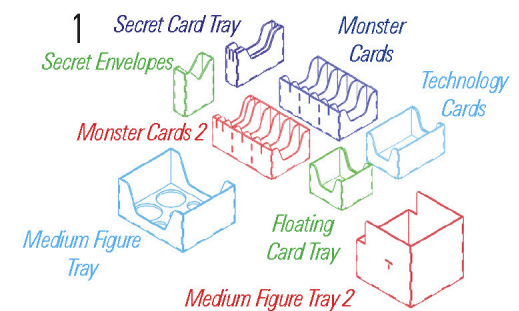

Share your creation!



#laseroxinserts

Watch our "How it fits" video and get your game organized!



<http://tiny.cc/lrxlato>

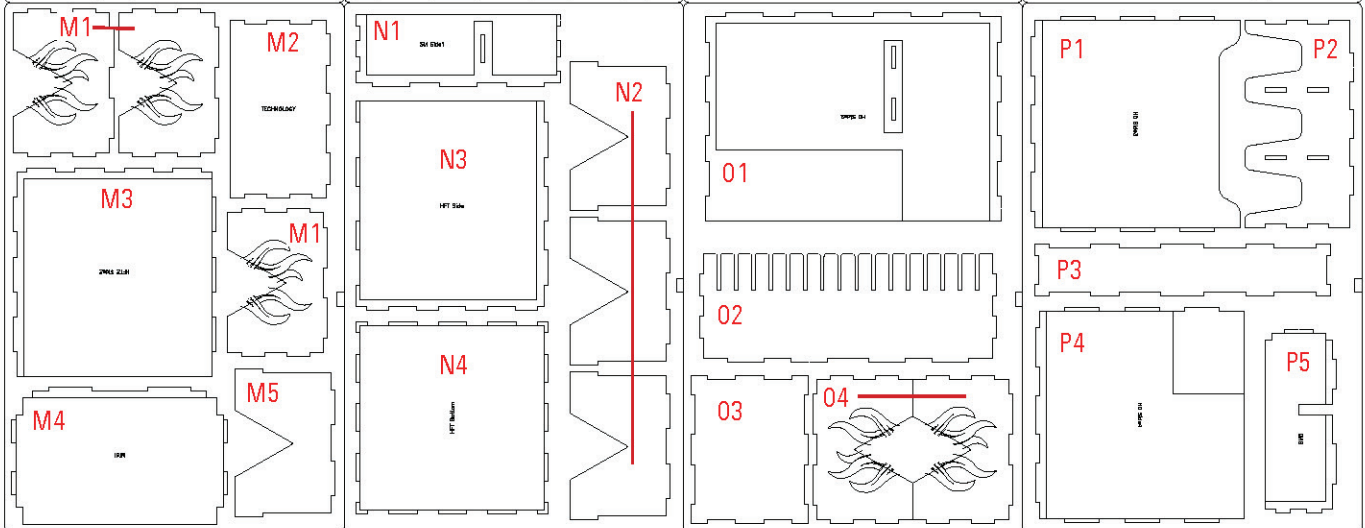
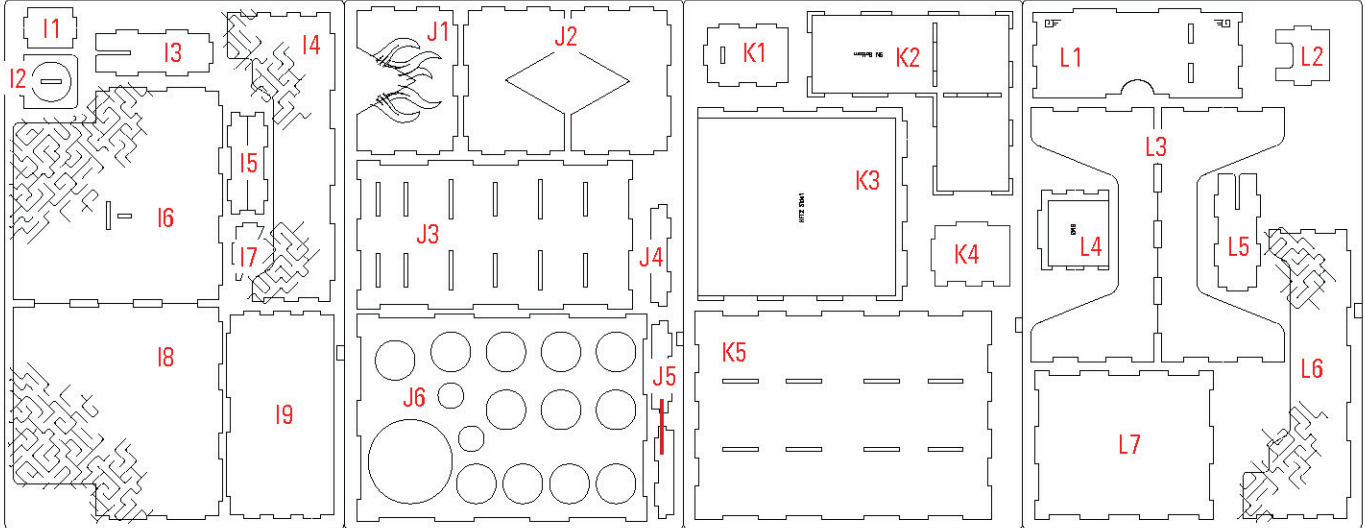
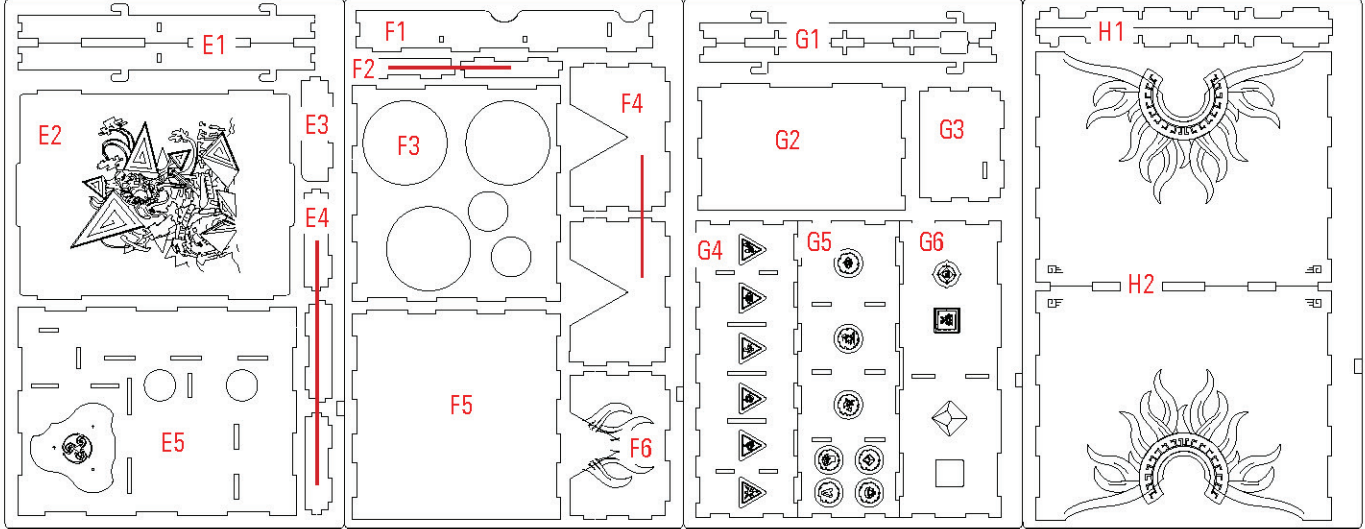
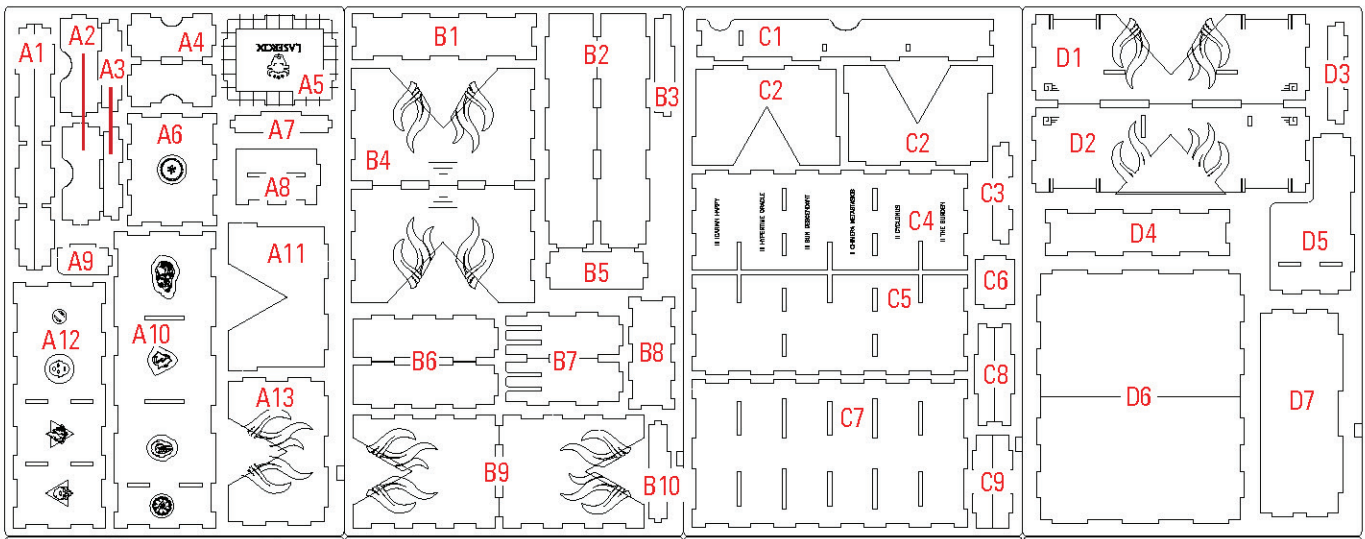

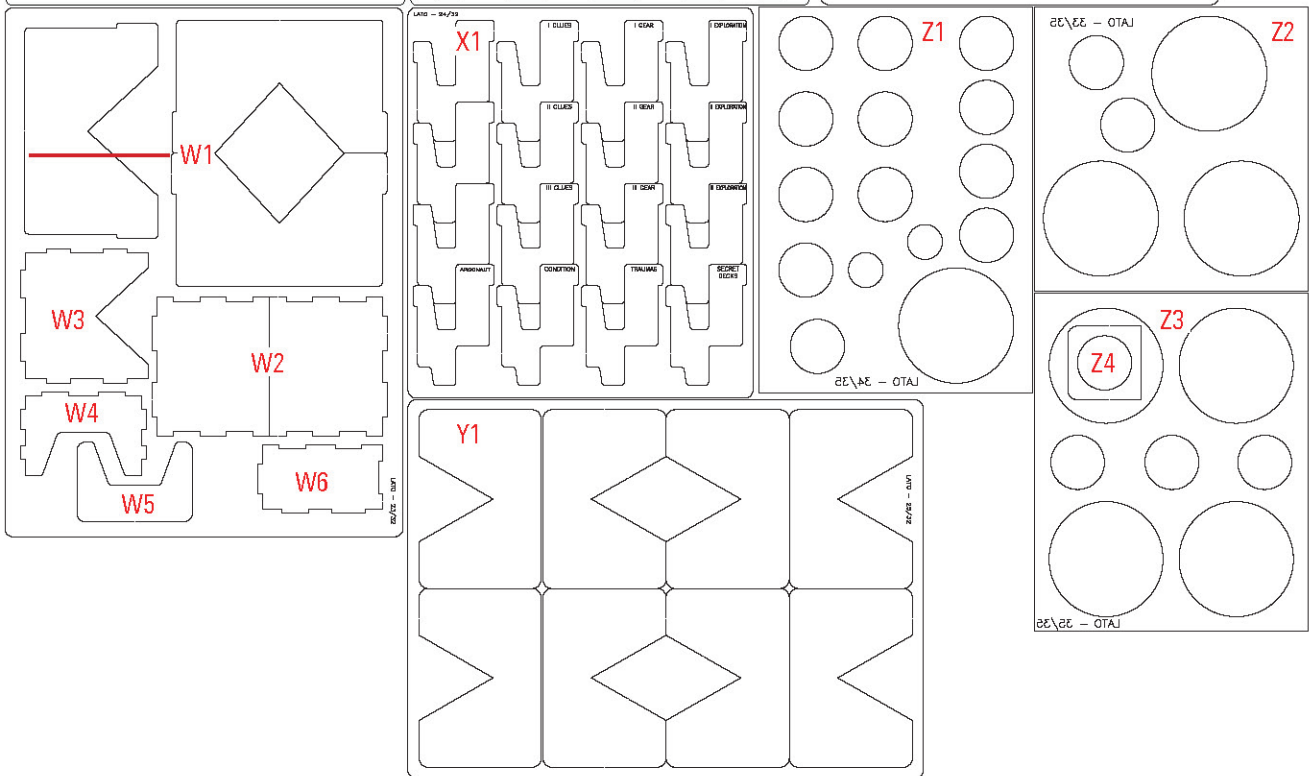
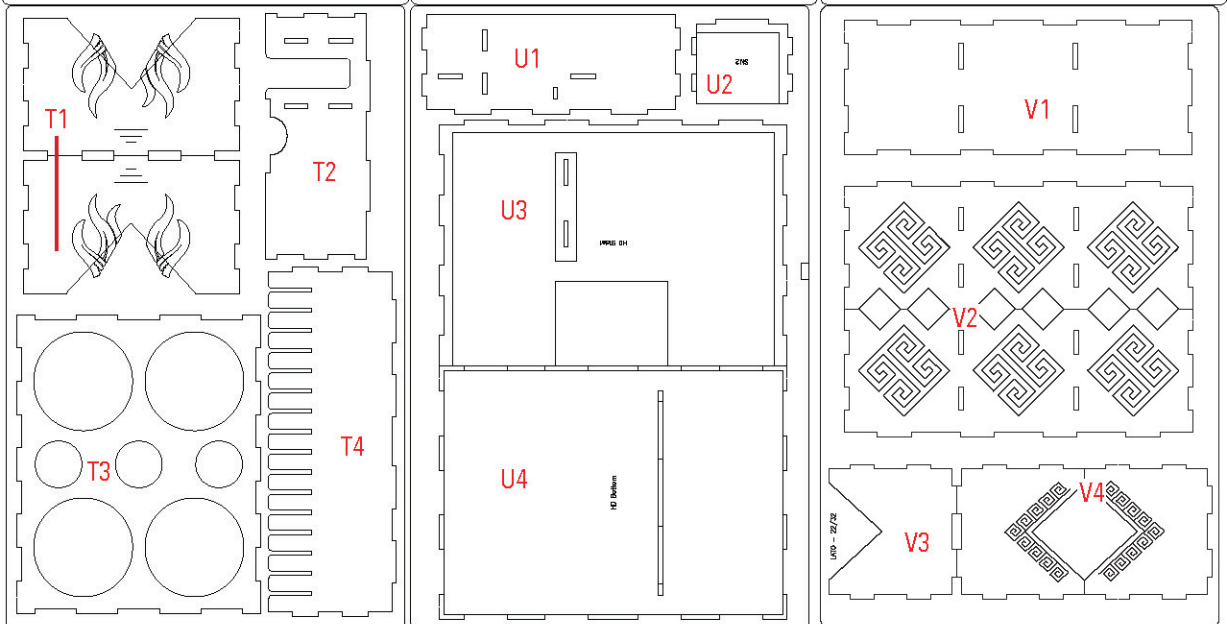



- Some parts might look different than in the assembly instructions, with added decorations/engravings/embellishments.
- Color variations or branch marks are a natural part of the birch plywood.
- The burnt smell of wood is natural and will dissipate with time.
- Rarely the laser will not cut through the complete sheet, but this can be fixed with the help of a hobby knife. If that is not possible, please contact us for a replacement!

Secret Card Tray

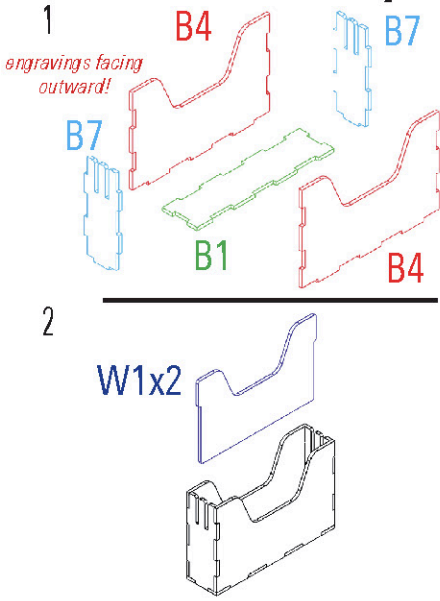

Required parts: **B4x2, B7x2, B1, W1x2**

Secret Card Tray 2

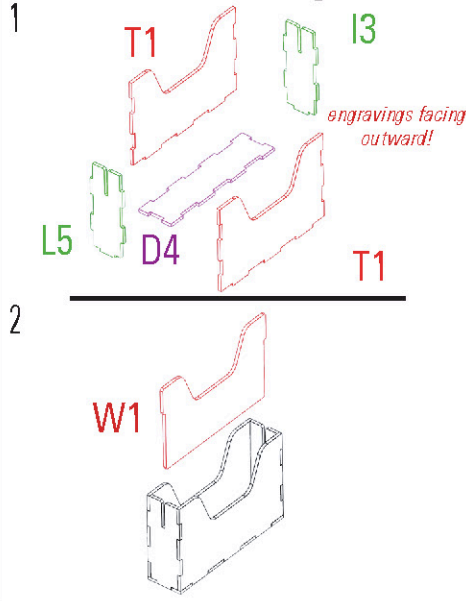

Required parts: **T1x2, I3, L5, D4, W1**

Mini Token Tray

LATO 5

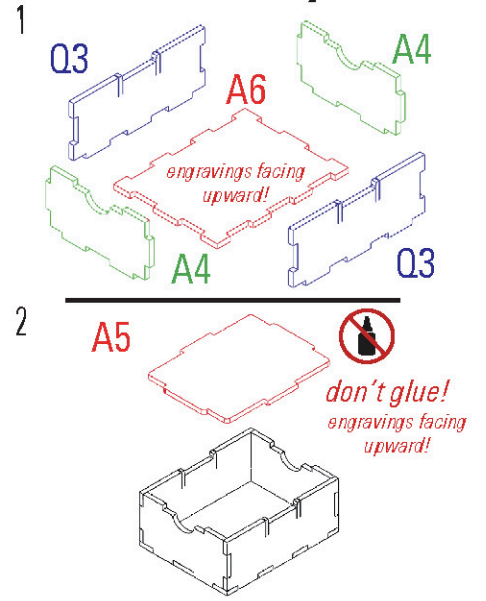

Required parts: **Q3x2, A4x2, A6, A5**

Small Card Tray

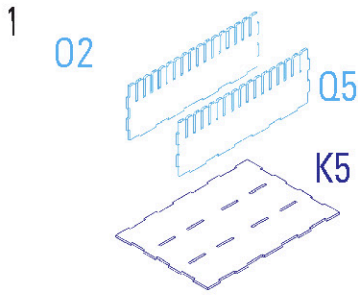

Required parts: **O2, Q5, K5, S2, T4, P2, S5, X1x16**

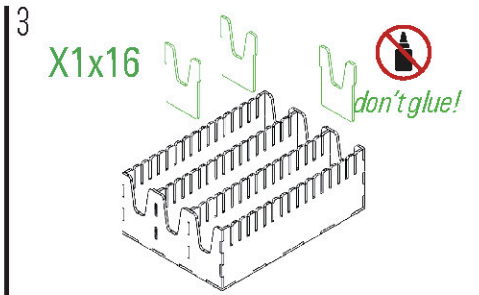

Medium Token Tray

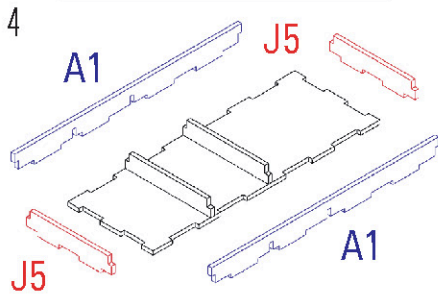
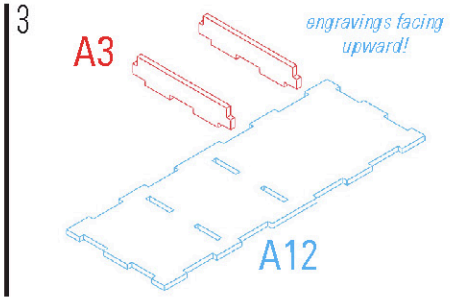
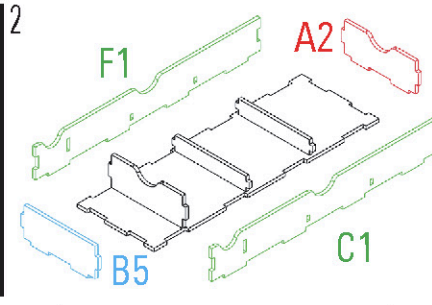
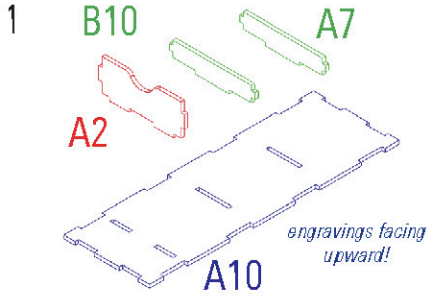

Required parts: **A10, A7, B10, A2, F1, C1, A2, B5, A3x2, A12, A1x2, J5x2**

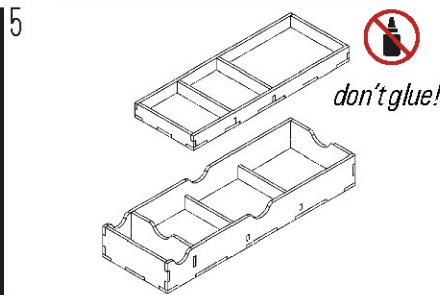

Secret Envelopes

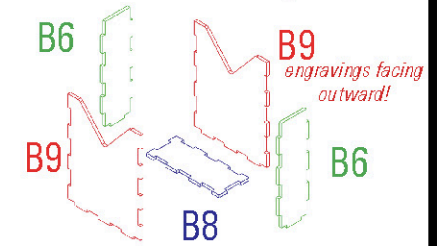

Required parts: **B6x2, B8, B9x2**

Large Token Tray

Required parts: E4x3, G6, E1x2, I5x2, J4, G5, G1x2, F2x2, C9x2, C8x2, B3, G4, H1x2, D3, C3

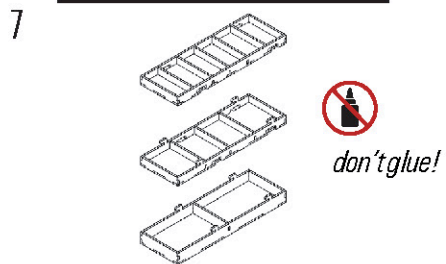
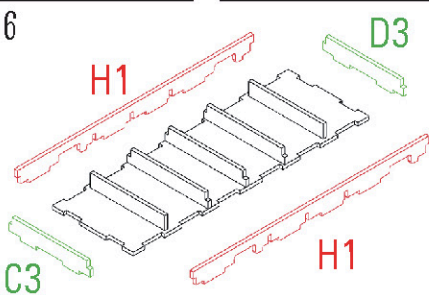
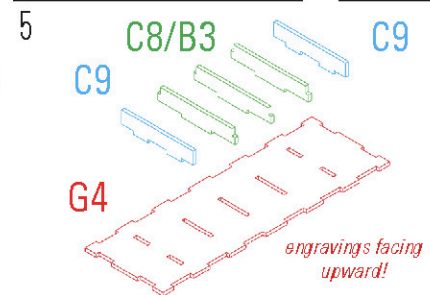
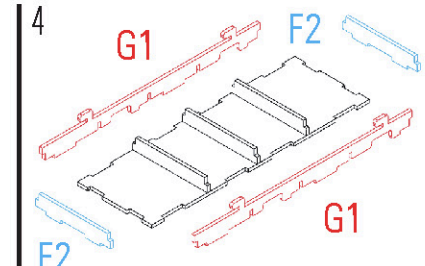
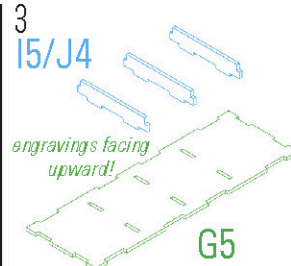
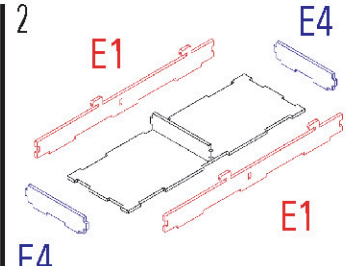
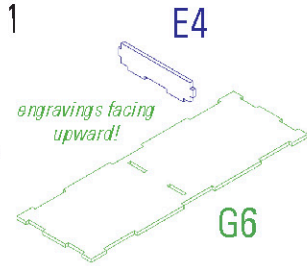

Huge Figure Tray

Required parts: N3/Q2/S1/S4, AA1, AA23x3, N4, AA24

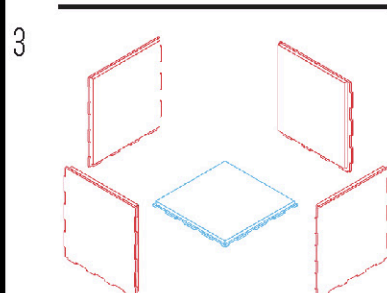
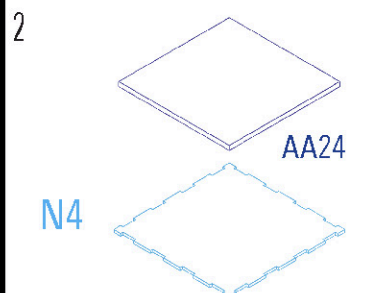
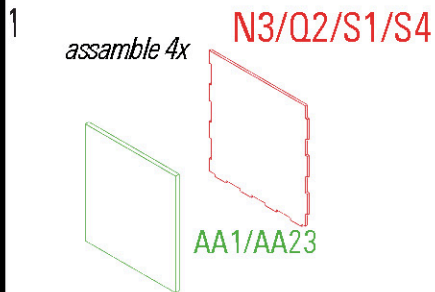

Huge Figure Tray 2

Required parts: M3, R1, AA2, AA8, AA8, K3, R5, AA7, AA18, Q4, AA25

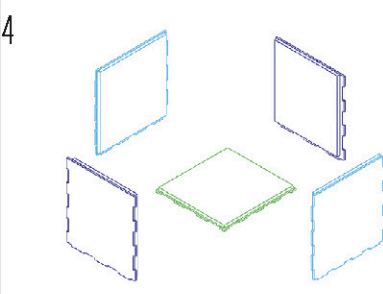
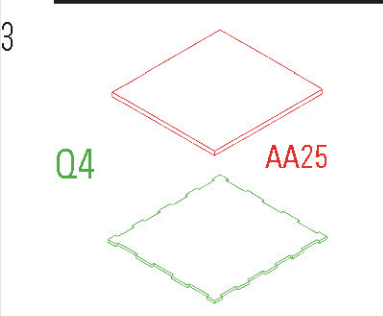
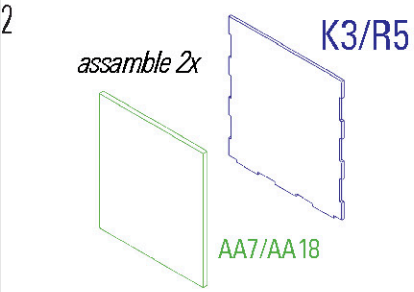
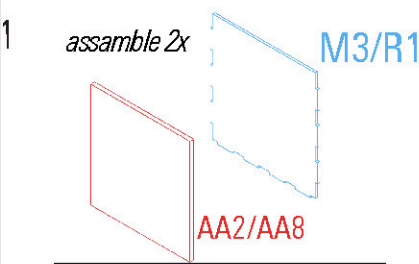

Medium Figure Tray 2

Required parts: Z4, I7, I2, Z2, F3, K4, W6, I6, W5, W4, F5, G2

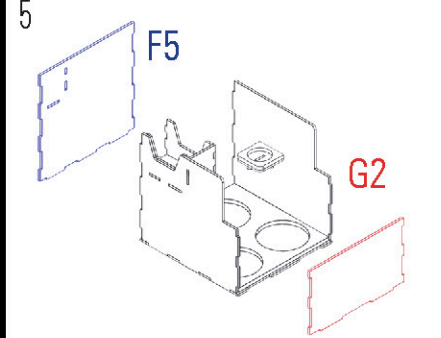
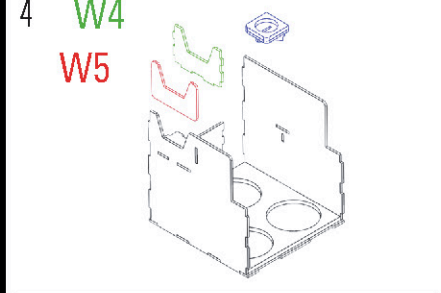
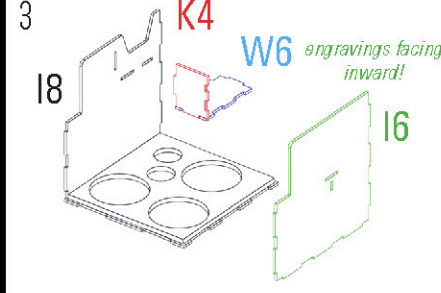
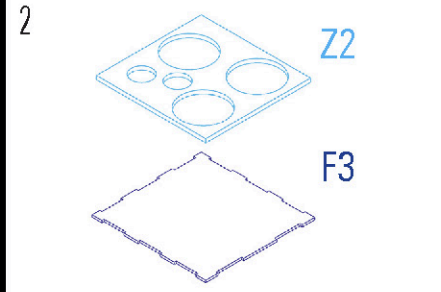
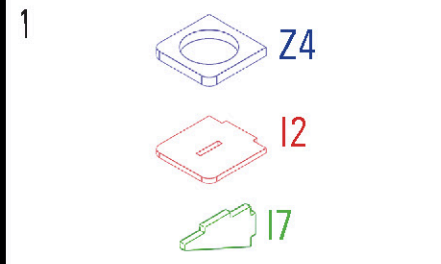

Huge Figure Tray 3

Required parts: U4, AA20, AA4, M4, AA11, AA14, P4, P1, AA16, O1, AA21, AA13, U3, AA12, K2, AA17, AA10, S3, AA5, P5, AA3, AA9, R3, AA22, N1, AA19, AA6, L4, AA15, U2

LATO 7

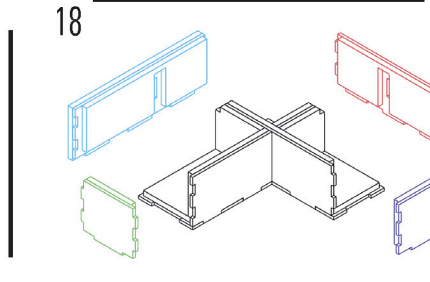
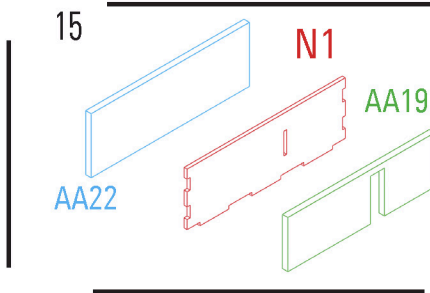
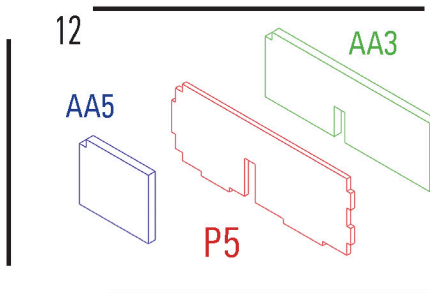
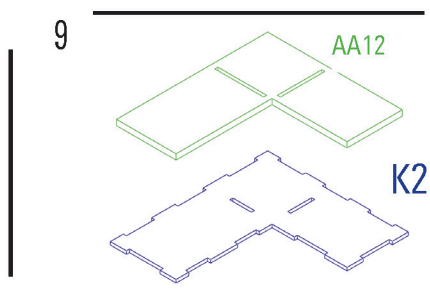
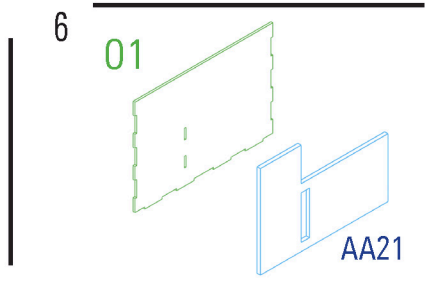
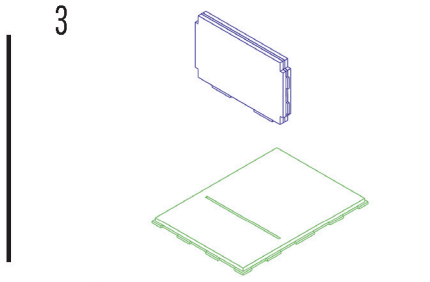
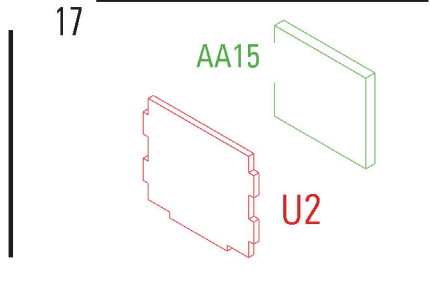
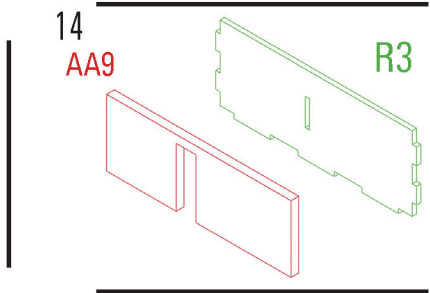
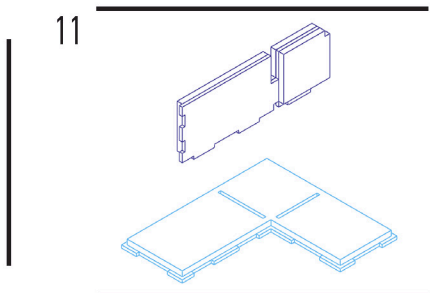
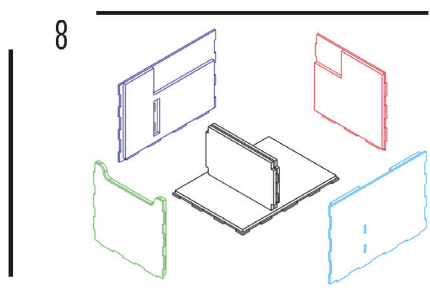
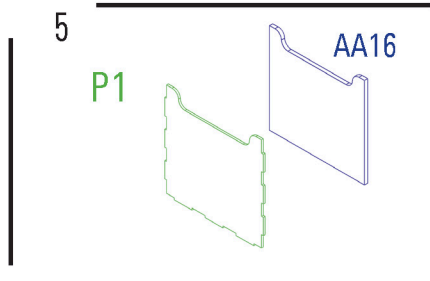
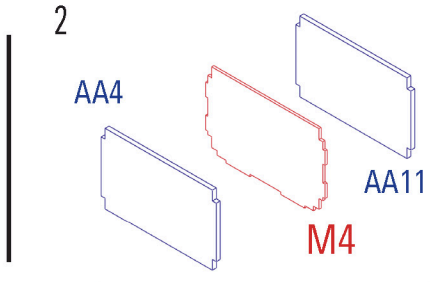
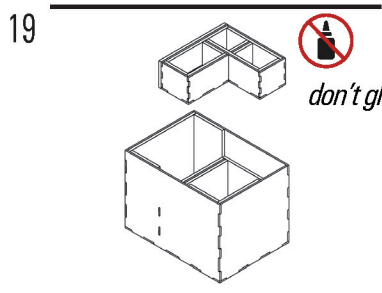
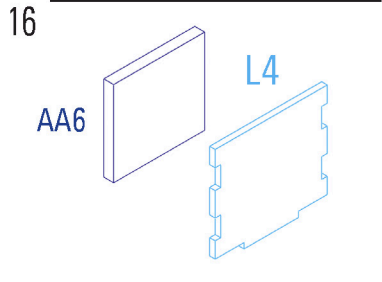
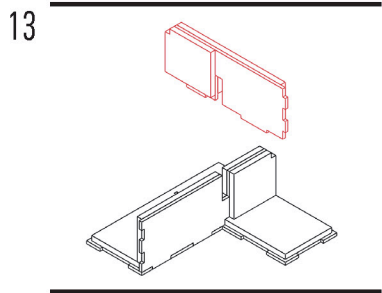
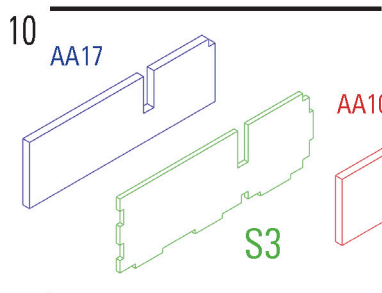
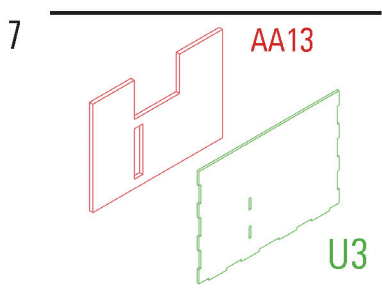
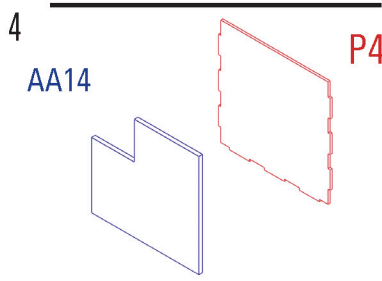
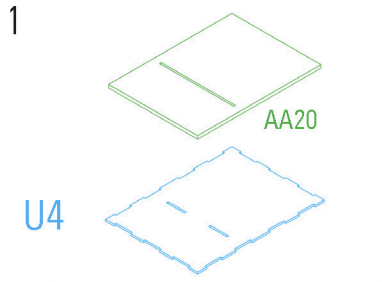

Map Tokens

Required parts: **K1, A8, U1, L2, A9, G3, D5, E5, E3, I1, C6, D2, T2, D1, L1, E2**

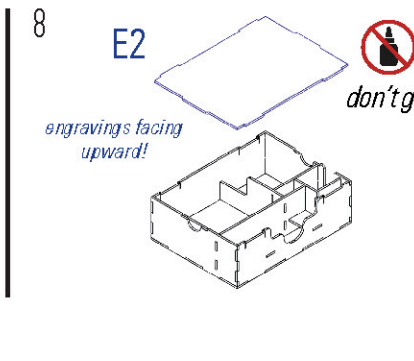
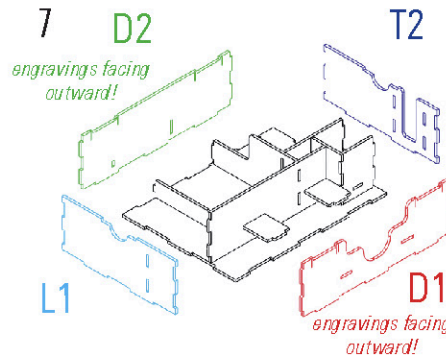
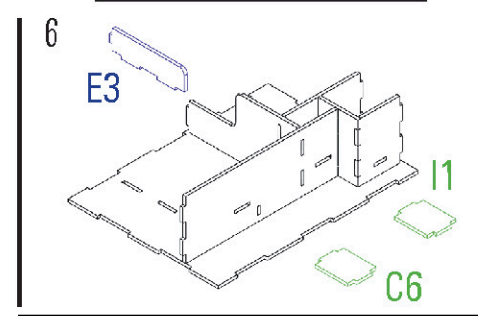
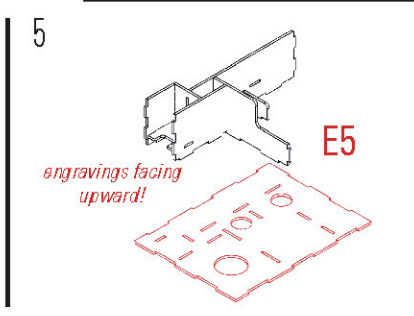
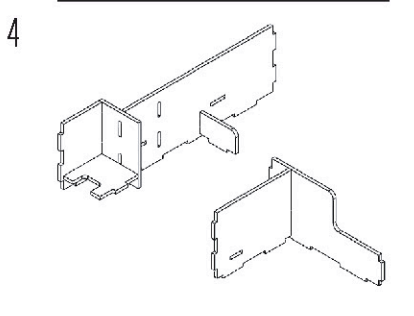
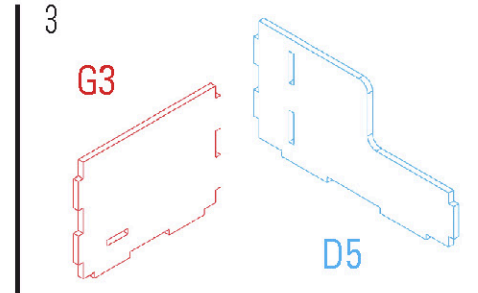
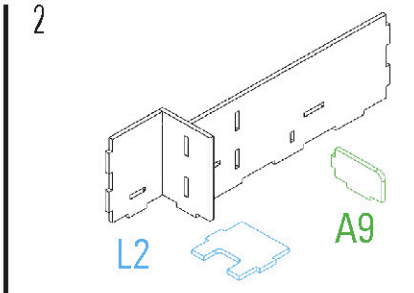
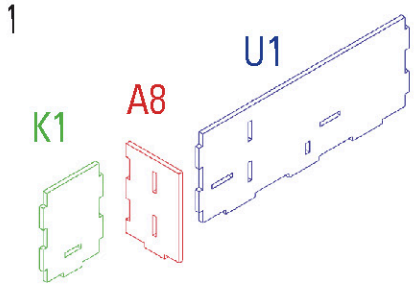

Sheet Storage

Required parts: **P3, B2x2, H2x2**

1

Small Figure Tray

Required parts: **Z1, J6, I9, D7, I4, L6**

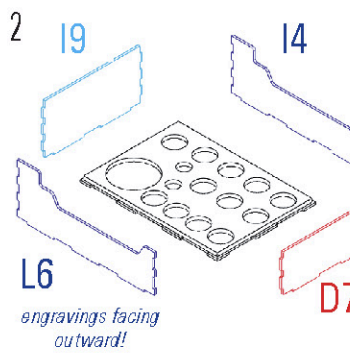
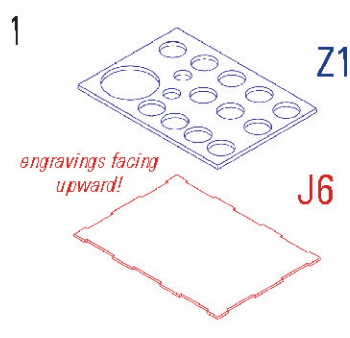

Medium Figure Tray

Required parts: **Z3, T3, D6x2, L3x2**

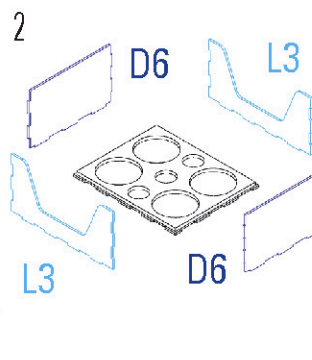
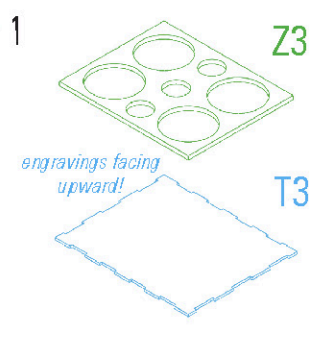

Floating Card Tray

Required parts: **M1x2, W2x2, O3, Y1x4**

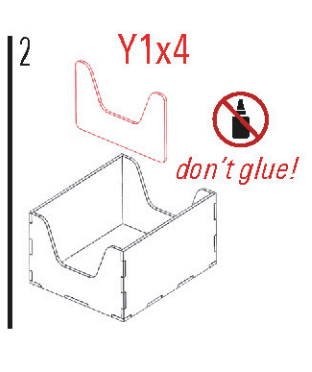
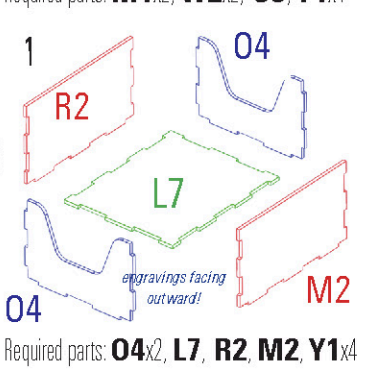
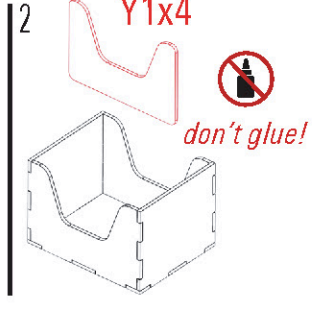
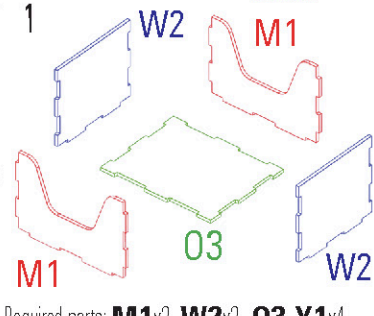

Monster Cards

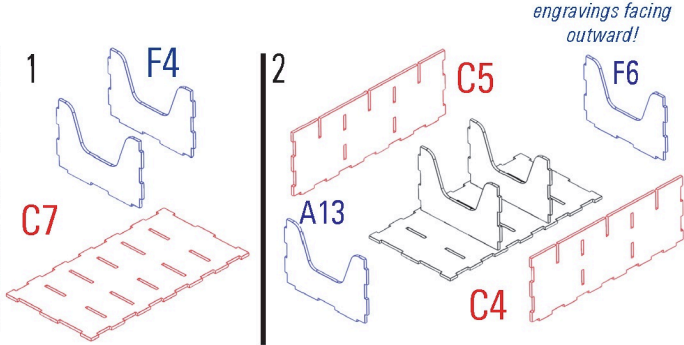

Required parts: **C7, F4x2, C5, C4, F6, A13, A11, C2x2**

Monster Cards 2

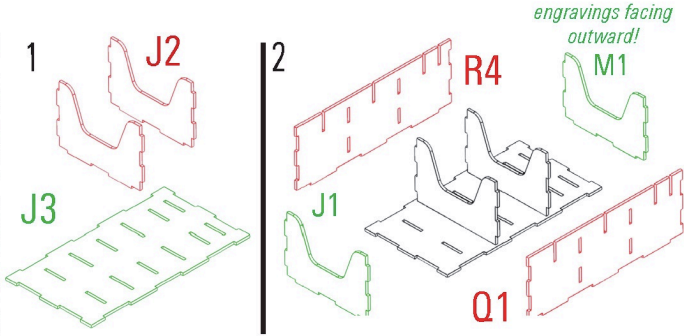

Required parts: **J3, J2x2, R4, Q1, M1, J1, M5, N2x3**

Map Cards

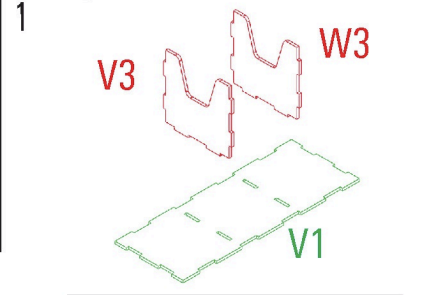

Required parts: **V3, W3, V1, V2x2, V4x2**



LASEROX

Laserox Design Ltd.
H-2092 Budakeszi
Tiefenweg way 39

