



User Manual

200 Watt Rigid Solar Panel

RSG200W

Congratulations on purchasing your ticket to energy freedom. Tap into the sun's radiance and power your devices anywhere. It will supply years of maintenance-free energy. Please read these instructions thoroughly prior to use, then store in a safe place for future reference.

Package Contents

1*rigid Solar Panel	1 *0.5m long DC5.5*2.1mm to MC4 cable
1*DC5.5/2.1 to DC3.5/1.35 connector	1*DC5.5/2.1 to DC5.5/2.5 connector
1*DC5.5/2.1 to DC8.0*5.5*0.8 connector	1*1m long MC4 to battery clips cable
1*User Manual	

Technical Specifications

Rated Power	200W
Convert Efficiency	≥22.5%
Peak Power Voltage(Vmp(V))	18.1V
Peak Power Current(Imp(A))	11.05A
Open circuit Voltage(Voc(V))	23.4V
short circuit Current(Isc(A))	12A
Panel type	Monocrystalline solar panel
Material	Glass surface monocrystalline silicon lamination + aluminum alloy frame
Output	MC4 DC18V 11.05A (Max)
Size	1480x680x30 mm
Weight	10.65kg

How to charge your device:

1. Place the panels under direct sunlight.
2. Connect your 12V-22V powered device to the solar charger.
3. Keep your device cool while charging. Place it under the solar panel, or in the shade to avoid overheating.

FAQ & Solutions

Q: What can I charge from the solar panel?

A: DC 12V~18V devices, such as power packs or power stations which can be charged by 18V solar panel.

Q: Is the solar panel waterproof?

A: It is water proof. IP rating is IP68.

1. If my device needs an input current of 1A, will the 2A output of the solar charger damage it?

No. The solar panel has intelligent charging, detecting the needs of your device and delivering exactly what it needs. If your phone accepts 1A, the charger will deliver 1A .

2.What if the solar panel is not charging my devices?

A. Check the manual of your device to ensure the input voltage 12V~18V (able to be charged by 18V solar panel).

B. Cloudy weather and indirect sunlight may cause fluctuations in the current. This in turn may hinder or prevent charging. Place the solar charger in direct sunlight or wait for the weather to clear.

C. Wipe the panels clean with a damp cloth between usage to prevent scratching.

D. Avoid exposure to fire, water and chemical liquid.

3. If it is partially cloudy or shady will the solar charger still work?

Yes, although the charging efficiency will be low causing prolonged charging time.

4. Will this panel charge a power bank?

No.This solar panel can only output 18V,not able to provide 5V to charge your USB base devices.Please make sure your devices that can be charged by a 12V/18V solar panel.

Caution

1. Do not break, dismantle, or drop this product.
2. Dispose the charger according to local environment laws.

Warranty

1 year from the date of purchase

Contact us

ROCKSOLAR TECHNOLOGY LLC.
Address: 500 DELAWARE AVE,STE
1 #1960 WILMINGTON,DE,US,19899
Tel: 1-800-858-4318
Email: services@rocksolars.com
Website: www.rocksolars.com



This device complies with part 15 of the FCC Rules. Operation is subject to the following two conditions:

- (1) This device may not cause harmful interference, and
- (2) this device must accept any interference received, including interference that may cause undesired operation



MADE IN CHINA

ROCKSOLAR[®]

Lithium iron phosphate battery
user manual

Contents

Features of LiFePO4 Battery Application	page	01
Battery Specification	page	03
BMS - Battery Management System	page	04
Charging Tips	page	05
State of Charge(SOC) Long-Term Storage	page	06
Connection Tips Parallel connection of batteries	page	07
Curve Of Lithium Iron Phosphate Battery	page	08
How To Activate The Battery Warning & Tips.	page	11
Troubleshooting	page	12

Features of LiFePO4 Battery

- **Longer Cycle Life:** Offers up to 20 times longer cycle life and five times longer float/calendar life than lead acid battery, helping to minimize replacement cost and reduce total cost of owner.
- **Lighter Weight:** About 40% of the weight of a comparable lead acid battery. A 'drop in' replacement for lead acid batteries.
- **Higher Power:** Delivers twice power of lead acid battery, even high discharge rate, while maintaining high energy capacity.
- **Wider Temperature Range:** -20°C ~+60°C .
- **Superior Safety:** Automatic protection with internal battery management system. Lithium Iron Phosphate chemistry eliminates the risk of explosion or combustion due to high impact, overcharging or short circuit situation.
- **Increased Flexibility:** Modular design enables deployment of up to four batteries in series and up to ten batteries in parallel.

Application

RV, Electric vehicles, Boat ; Solar/wind energy storage system; UPS, backup power ; Telecommunication; Medical equipment; Lighting.



Warranty

Limited Warranty

ROCKSOLAR LLC. provides a non-transferable warranty to the purchaser of ROCKSOLAR product purchased from an authorized ROCKSOLAR reseller. ROCKSOLAR LLC. warrants to the original consumer purchaser that the ROCKSOLAR product will be free from defects in workmanship and material under normal consumer use during the applicable warranty period identified in the 'Warranty Period' section below, subject to the exclusions set forth below. This warranty statement sets forth ROCKSOLAR's total and exclusive warranty obligation. We will not assume, nor authorize any person to assume for us, any other liability in connection with the sale of our products.

Warranty Period

The warranty period for portable power stations is 12 months, while the warranty period for LiFePO4 batteries is 11 years. In each case, the warranty period is measured starting on the date of purchase by the original consumer purchaser. The sales receipt from the first consumer purchase, or other reasonable documentary proof, is required in order to establish the start date of the warranty period.

Remedy

ROCKSOLAR's entire liability and your exclusive remedy for any ROCKSOLAR product that is not operating in accordance with its published technical specifications are at ROCKSOLAR's discretion: replace the product at ROCKSOLAR's expense. This warranty obligation is conditioned upon the hardware being returned to the original place of purchase, or another place as directed by ROCKSOLAR, with the original sales receipt attached. You may be required to pay shipping and handling charges, as well as any applicable tariffs, duties, taxes, or other fees. ROCKSOLAR may, at its discretion, provide new or refurbished products.

Limited to Original Consumer Buyer

The warranty on ROCKSOLAR's product is limited to the original consumer purchaser and to any subsequent owner.

LIMITATION OF LIABILITY

ROCKSOLAR shall not be liable for any special, incidental, indirect, or consequential damages whatsoever, including, but not limited to loss of profits, revenue, or data (whether direct or indirect) or commercial loss for breach of any express or implied warranty on your product even if ROCKSOLAR has been advised previously of the possibility of such damages. Some local laws do not allow the exclusion or limitation of special, indirect, incidental, or consequential damages, so this limitation or exclusion may not apply in your jurisdiction.

Exclusions

The warranty does not cover failures resulting from incorrect handling, product modifications, installation, conversion or additions, supplements, operation, natural elements (weather), excessive or deficient energy supply, chemicals, the effect of solid bodies, or deliberate damage. If the Warrantor determines that the problem with the ROCKSOLAR product(s) is not due to a manufacturing defect in the Warrantor's workmanship or materials, or otherwise does not qualify for warranty repair, then the Purchaser will be responsible for all costs incurred by the Warrantor necessary to repair, replace and transport the ROCKSOLAR product(s). ROCKSOLAR's warranty does not apply to the battery cell unless the battery cell is fully charged by you within seven days after you purchase the product and at least every 3 months thereafter.

How to Receive Service

To obtain warranty service, contact our customer service team at support@rocksolars.com.

Battery Specification

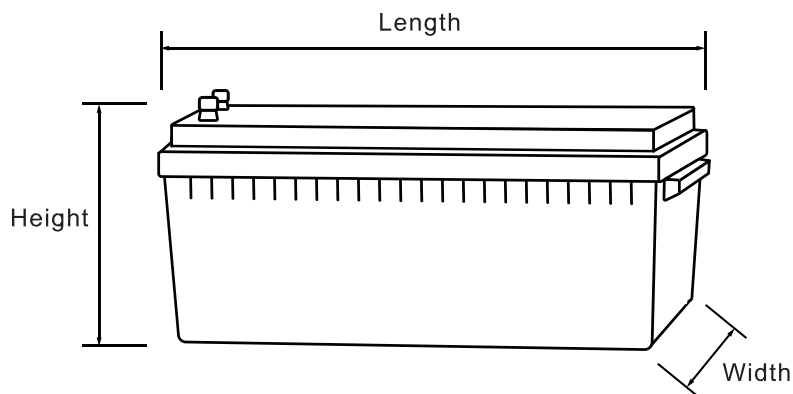

MODEL	48-50	48-100
Nominal Voltage	51.2V	
Nominal Capacity	50Ah	100Ah
Nominal Energy	2560Wh	5120Wh
Standard Charge Voltage	57.6(58.4V Max.)	
Standard Charge Current	10A	20A
Allowed Max. Charge Current	50A	100A
Max. Discharge Current	50A	100A
Peak Discharge Current @10S	100A	200A
Terminal	F12 M8	F12 M8
Dimensions L*W*H	20.5*9.4*8.6 in	20.5*10.6*8.6 in
Temperature	Charge temperature:0°C~ +45°C / Discharge temperature -20°C~ +60°C	
Cycle Life	>2000 cycles @1C 100%DOD / > 8000 cycles @0.5C 50%DOD	

BMS - Battery Management System

Protection		Protection Condition		Recovery
Current	Charging	< 1.0C	Temperature Protection	a. Cut Charging 15±5S or b. Discharge > 2A or c. < +50°C and > 0°C or d. Charge Current < 0.5C
		1.0~1.5C	Delay 3~10S	
		1.5~3.0C	Delay 1~3S	
		> 3.0C	Delay 50~ 150mS	
	Discharging	< 1.0C	Temperature Protection	a. Cut Discharge 15±5S or b. Charge > 2A or c. < +65°C and > -20°C or d. Discharge Current < 0.5C
		< 2.0C	Temperature Protection	
		3.0~4.0C	Delay 50~ 150mS	
		4.0~10C	Delay 5~ 15mS	
		> 10C	Delay 300~800uS	
Voltage	Charging	Battery	≥59.2V, Delay 1~2S	a. ≤56.0V or b. Discharge > 2A
		Single Cell	≥3.65V, Delay 1~2S	a. ≤3.5V or b. Discharge > 2A
	Discharging	Battery	≤38.4V, Delay 1~2S	a. ≥45.6V or b. Charge > 2A
		Single Cell	≤2.3V, Delay 1~2S	a. ≥2.7V or b. Charge > 2A
temp-erature	Battery	Charging	≤0°C or ≥+50°C	≥+5°C or ≤+45°C
		Discharging	≤-20°C or ≥+70°C	≥-10°C or ≤+60°C
	BMS		≥+90°C	≤+80°C
Balance for single cell		Voltage	≥3.55V, Delay 1~10S	a. Cut Charging or b. Voltage ≤3.5V
		Current	36±10mA	

Explain: “C” represents the Battery Nominal Capacity.

Charging Tips

About Charging Voltage

Based on the characteristics of Lithium Iron Phosphate(LiFeP04) batteries, the voltage measured by all LiFeP04 batteries during charging is not the real voltage of the battery. Therefore, after charging and disconnecting the battery from the power source, the voltage of the battery will gradually drop to its real voltage. If you need to test the real voltage of the battery, please charge and disconnect the power supply and test its voltage after putting it aside for over 15 mins.

Charging Methods

Use 58.4V lithium battery charger to maximize the capacity.

Recommend Charging Voltage: Between 56.8V to 58.4V

Recommend Charging Current:

0.2C The battery will be fully charged in around 5hrs to 100% capacity.

0.5C The battery will be fully charged in around 2hrs to around 97% capacity.

Inverter/Controller

·Select"48V(58.4V)LI(LiFeP04) Mode" or

·Select "User Mode" to enter values according to below parameters:

CHARGING	Charging Limit Voltage	58.4V
	Over Voltage Disconnect Voltage	60.0V
	Over Voltage Reconnect Voltage	56.8V
	Equalizer Charging Voltage	56.0V
	Float Charging Voltage	55.2V
	Boost Charging Voltage	55.2V
	Boost Reconnect Charging Voltage	52.8V
DISCHARGING	Low Voltage Disconnect Voltage	43.2V
	Low Voltage Reconnect Voltage	49.6V
	Under Voltage Warning Voltage	46.4V
	Under Voltage Warning Reconnect Voltage	48.0V
	Discharging Limit Voltage	41.6V
	Over Discharge Disconnect Voltage	41.6V
	Over Discharge Reconnect Voltage	46.4V
	Over-Discharge Delay Time	0.8S
OTHERS	Equalize Duration	120min
	Boost Interva	Not Suitable for Lithium Batteries
	Boost Duration	120min

State of Charge(SOC)

The battery capacity could be roughly estimated by its voltage. As there are subtle differences in the voltage of each battery, below parameters are for reference only. The voltage needs to be tested at rest (with zero current) after 15 mins of disconnecting from charger & loads.

Capacity	Voltage
100%	54.00V
99%	53.60V
90%	53.20V
80%	53.00V
70%	52.80V
60%	52.70V
50%	52.55V
40%	52.40V
30%	52.00V
20%	51.60V
10%	51.20V
1%	43.20V (recommend low voltage disconnect voltage)
0%	38.00V

Long-Term Storage

·The battery can be operated in temperature of -20°C to $+60^{\circ}\text{C}$, and a temperature between $+10^{\circ}\text{C}$ to $+35^{\circ}\text{C}$ is ideal for long-term storage. Store in a fireproof container and away from children.

·For a longer-lasting product, it is best to store your battery at 100% charge level and recharge every three months if it is not going to be used for a long period of time.

Parallel Batteries

Connection Tips

Check as below before connecting :

- a. connect batteries with same capacity(Ah) ONLY.
- b. connect batteries with the same brand ONLY.

Two Necessary Steps Before Connecting:

These two steps are necessary in order to reduce the voltage difference between batteries, and through these, the battery system can perform the best of it in parallel.

Step 1: Fully charge your batteries separately.

Step 2: Connect your batteries one by one in parallel.

Parallel connection of batteries

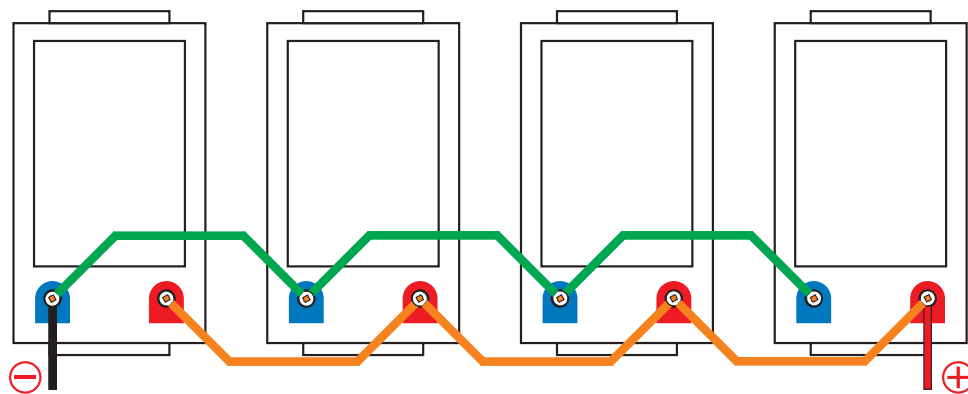

Capacity of parallel battery	Battery Numbers	Limited Charge Voltage	Discharge Cut-off voltage
12.8V/Capacity*1	1PCS	58.4V	43.2V
12.8V/Capacity*2	2PCS	58.4V	43.2V
12.8V/Capacity*3	3PCS	58.4V	43.2V
12.8V/Capacity*n	n≤10PCS	58.4V	43.2V

Curve Of Lithium Iron Phosphate Battery

Charging curve

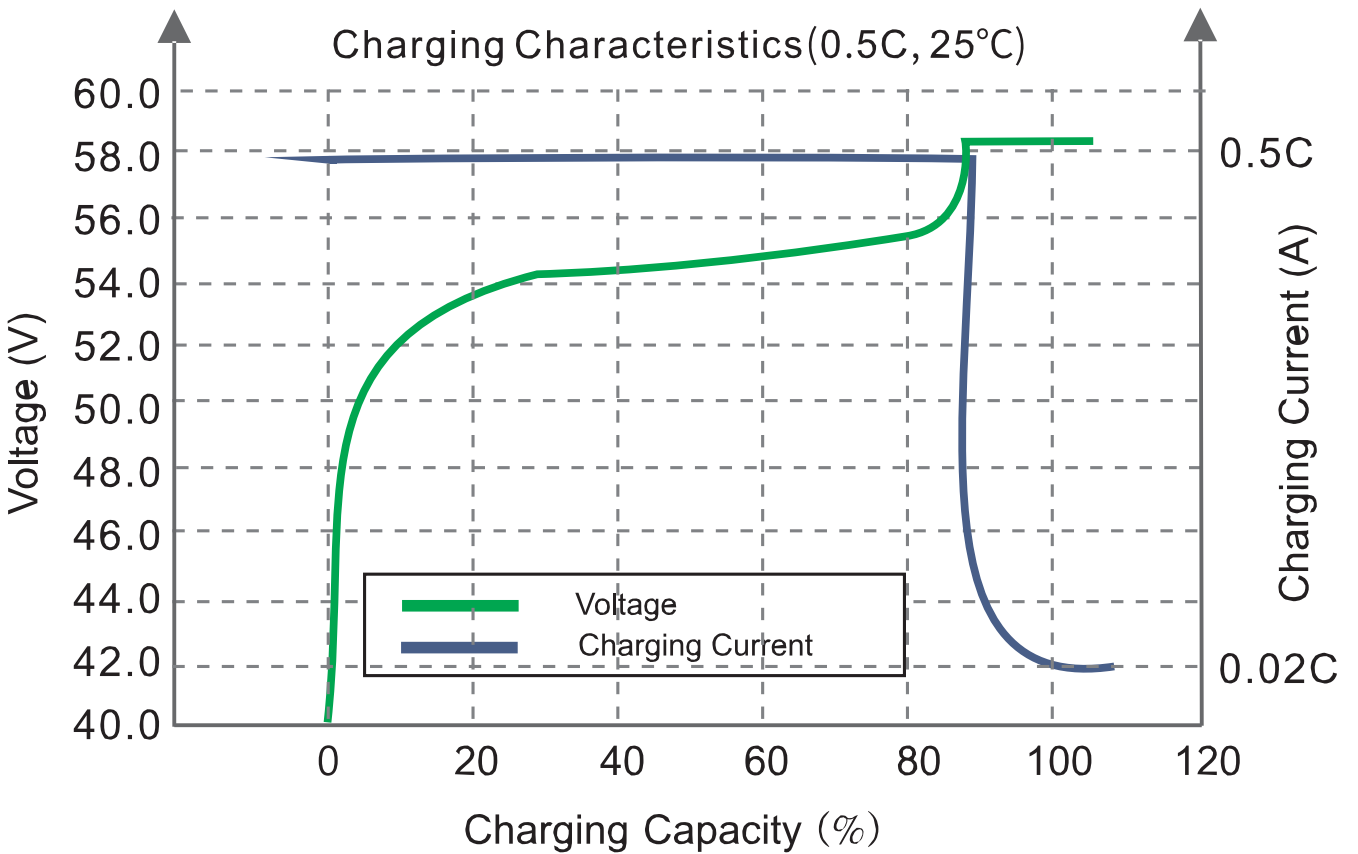
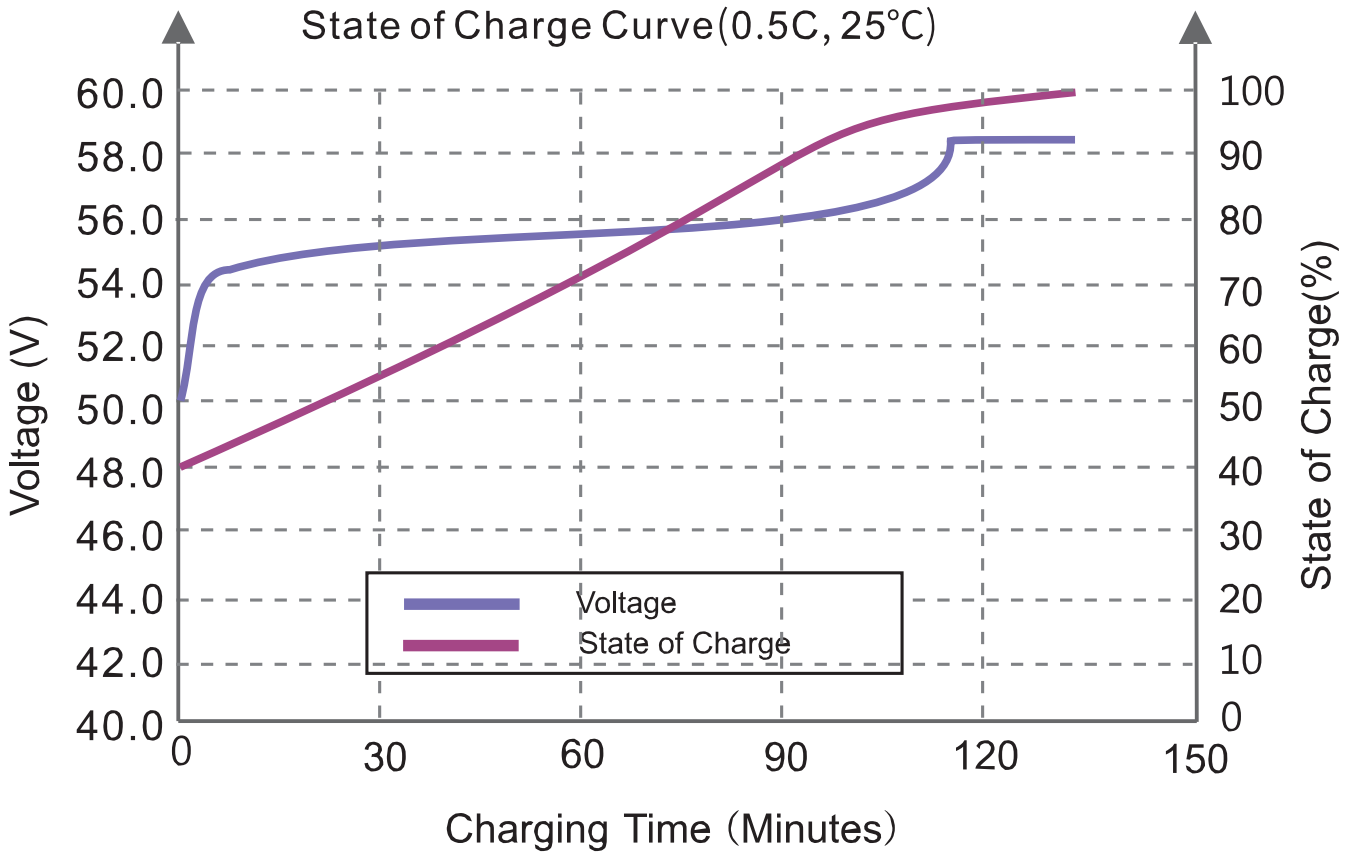

Discharge Curve

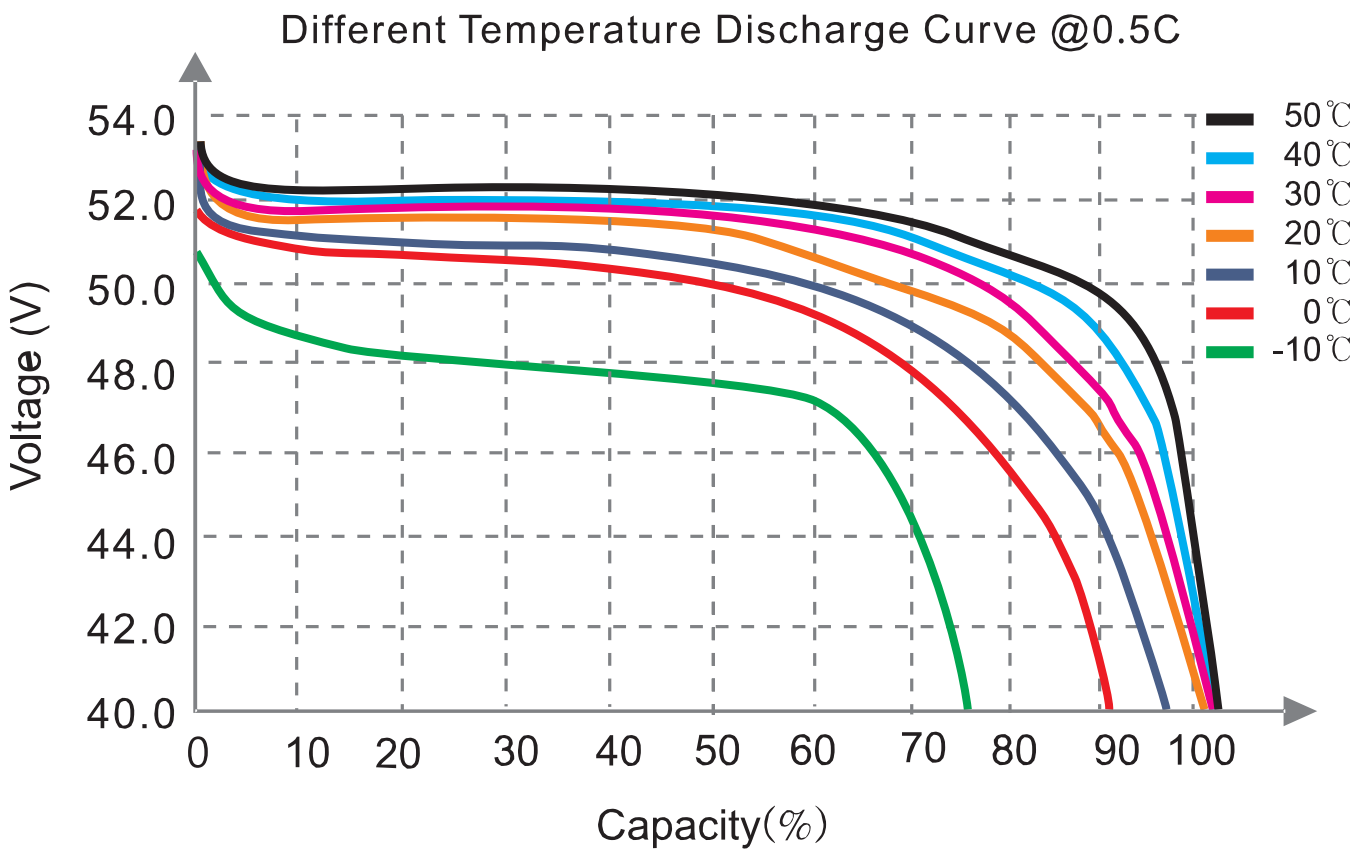
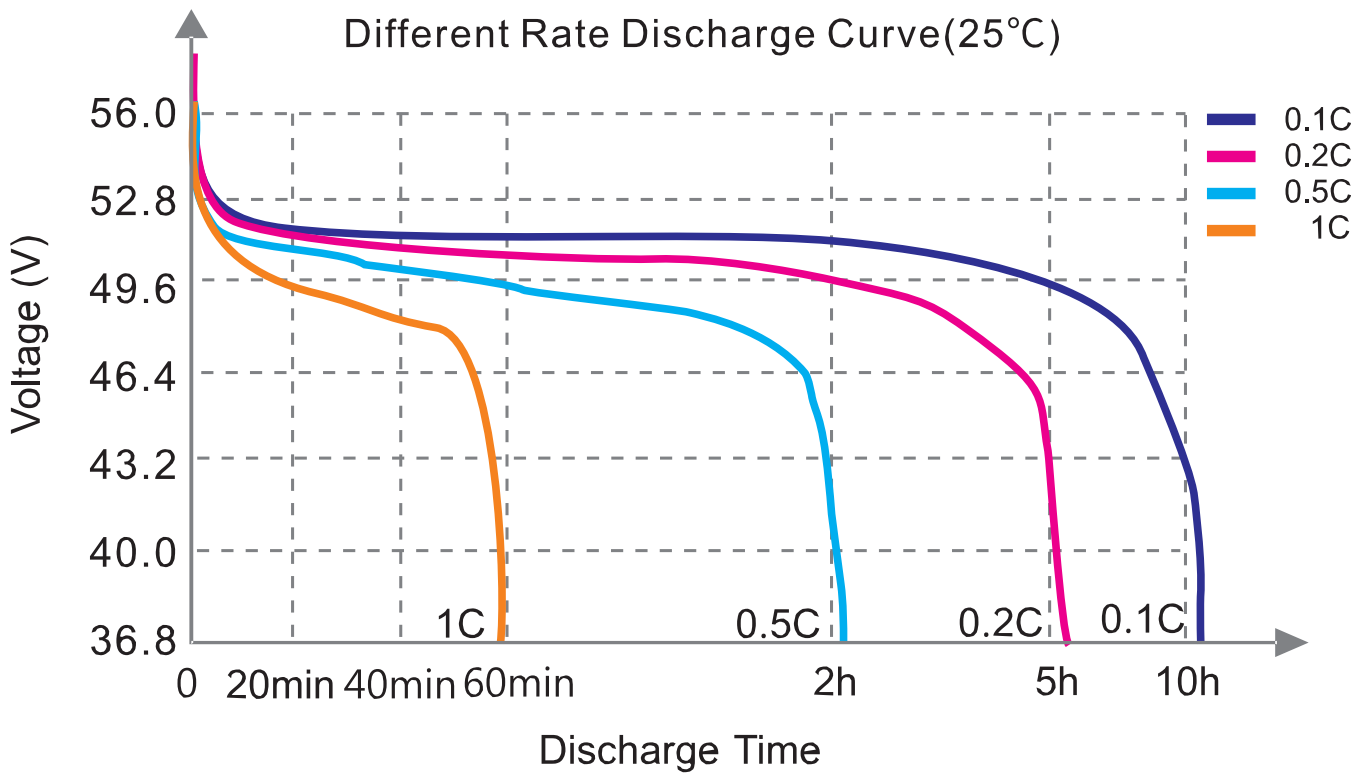

Discharge Cycle Life Curve /Self Discharge Curve

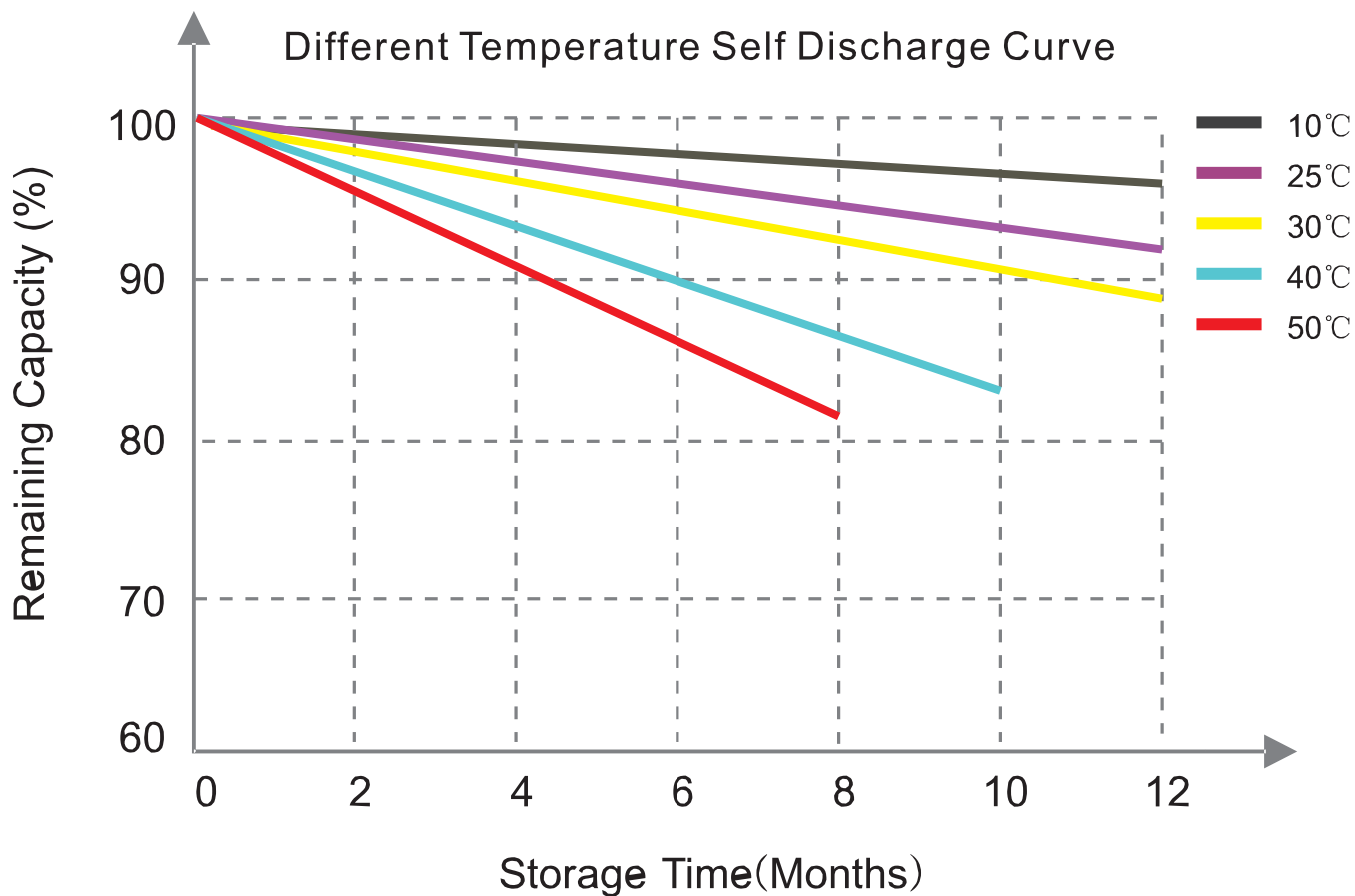
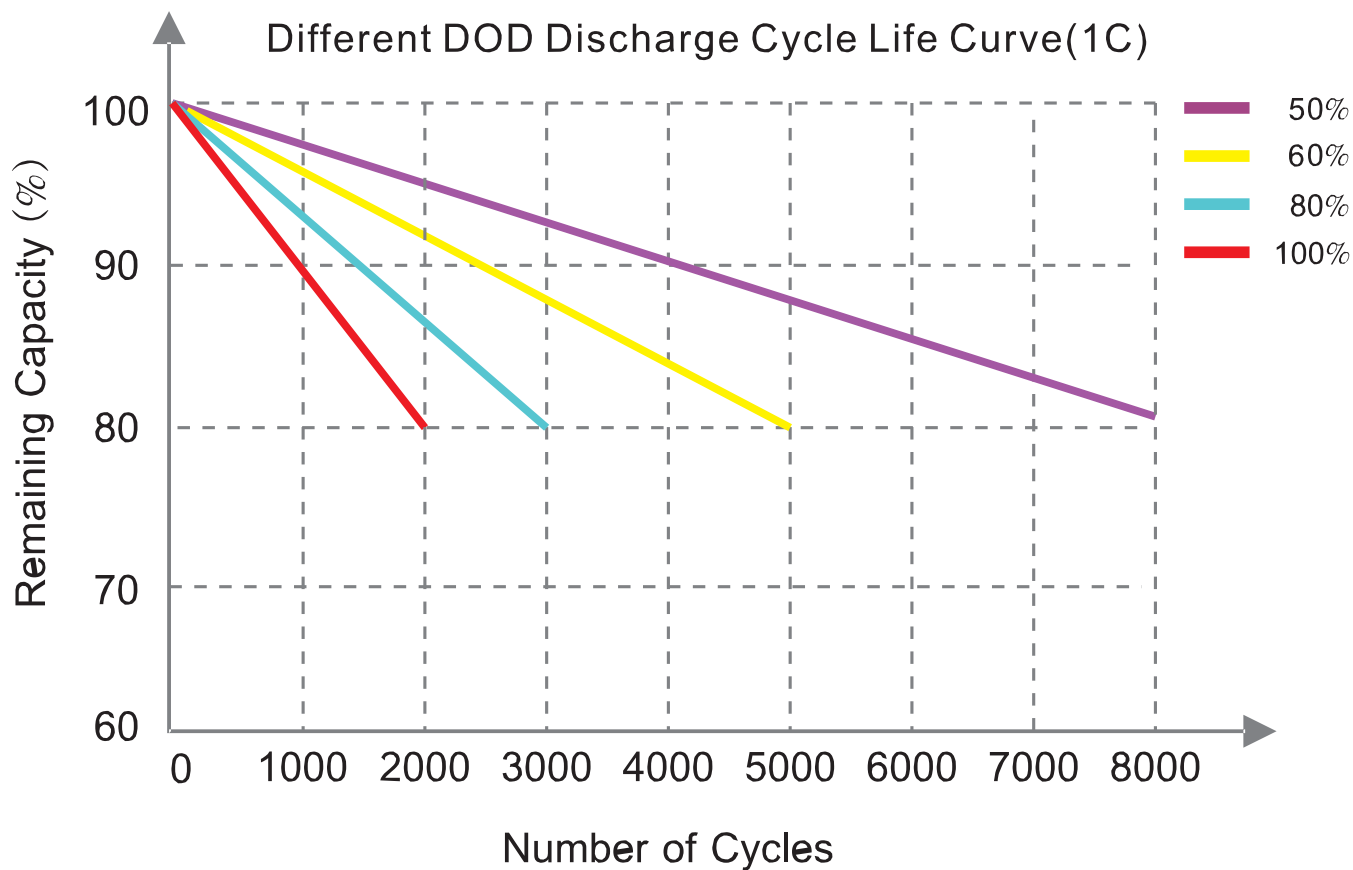

How To Activate The Battery

If the BMS has cut-off the battery for protection, you need to cut off the load of the battery and put the battery aside for 30mins. Then the battery will automatically recover itself to normal voltage and can be used after fully charged.

If the battery is unable to recover itself and its voltage is too low to hold a charge, you can activate it in below two ways:

1. Use the charger with 0V charging function (it can charge the battery starting from 0V) to charge the battery. After fully charged, the battery can be used normally.
2. Use another 48V lithium battery to connect in parallel with the battery for a minute to activate the battery (lead-acid battery at voltage between 48V and 58.4V will also work). After that, fully charge the battery and it can be used normally.



Warning & Tips.

1. DO NOT disassemble or alter the battery.
2. DO NOT reversely connect or short-circuit the positive and negative poles of the battery.
3. DO NOT soak the battery in water, especially sea water.
4. DO NOT throw the battery into fire.
5. DO NOT Heat above 70°C/158°F.
6. DO NOT use the wrong charger with output below 54.0V or over 60.0V.

Troubleshooting

Can not discharge.

1. Check whether the battery is securely connected.
2. Check whether the positive and negative battery terminals are correctly connected.
3. Check whether the battery voltage is greater than 48V. If it is less than 48V, charge the battery first.
4. Check whether the load voltage matches the battery.
5. Check whether the load current is greater than the battery discharge current, Make sure it is less than the battery discharge current.
6. Ensure that the ambient discharge temperature ranges from -15°C to $+55^{\circ}\text{C}$.

Can not charge

1. Check whether the battery is securely connected.
2. Check whether the positive and negative battery terminals are correctly connected.
3. Check the charging voltage matches the battery , the charging parameters are set correctly.
4. Check whether the charging current is greater than the maximum charging current of the battery, Make sure it is less than the maximum charging current of the battery.
5. Check whether the battery voltage is less than 36V. If it is less than 36V, use the charger with 0V charging function to charge.
6. Ensure the charging environment temperature ranges from 0°C to $+45^{\circ}\text{C}$.
7. After the battery is protected by over-discharge, disconnect the load and wait for the battery to recover the voltage before charging, or use the charger with 0V charging function to charge.

Battery heats up

1. Check whether the battery is securely connected. The connecting wire should be in contact with the battery terminal. Do not clamp screws to discharge.
2. Check whether the battery cable matches the working current. 6AWG-100A, 4AWG-150A, 2AWG-200A cable is recommended.
3. Check whether the load power exceeds the battery discharge power, ensure the load power is lower than the required battery power.
4. Ensure the working temperature is lower than 55°C .

ROCKSOLAR®

BLP SERIES

PURE SINE WAVE INVERTER

USER MANUAL

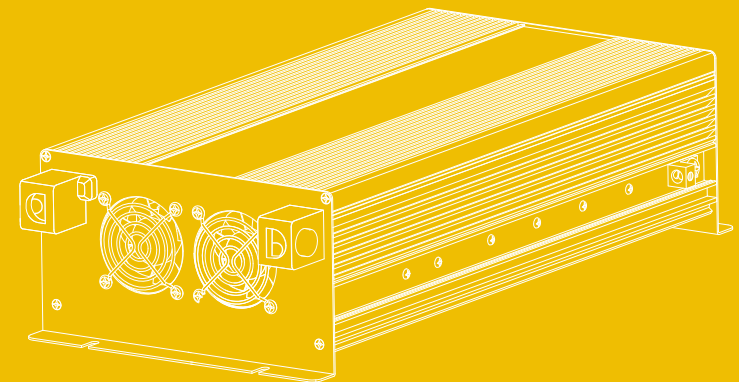

ROCKSOLAR TECHNOLOGY LLC.

Address: 500 DELAWARE AVE,STE 1 #1960 WILMINGTON,DE,US,19899

Tel: 1-800-858-4318

Email: services@rocksolars.com

Website: www.rocksolars.com

CATALOG

1. Attention and Warning	3
2. Product Description	4
3. Inverter Application	5
4. Appearance	7
5. Product Installation	9
6. Product Parameter List	13
7. Display Function	14
8. Display and Control Panel	15
9. Total Harmonic Distortion(THD)	18
10. General Technical Requirements	18
11. DC Input Cable Requirements	18
12. Features	18

Please keep it properly after reading

In order to ensure reliable service for you, the inverter must be installed and used properly. Before installation and use, please read the installation and operating instructions. Please pay special attention to the warnings and their explanation in this manual, for some warning of use conditions and practice caution that can lead to inverter damage. And the clear warning statement for certain conditions of use and practices which are likely to cause personal injury. Read all tips before using the inverter.

Please read this instruction manual carefully to facilitate the correct use. Especially before using, please remember to read the details of the "Safety Precautions" to ensure safe use. After reading the instruction manual, please keep it properly for future reference.

Accessories:

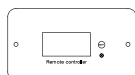

Remote control panel
(Optional, need to be purchased separately)

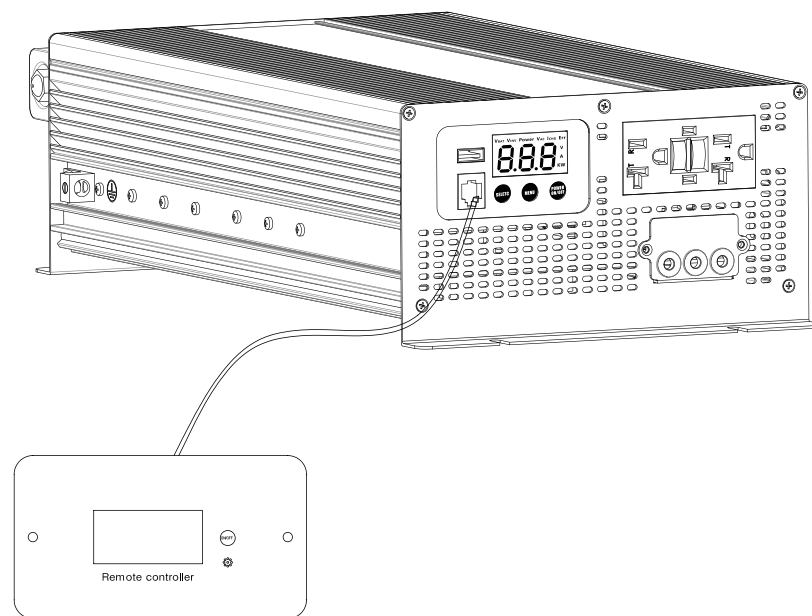

BLP1000ARW-* • **BLP1000BRW-***
BLP2000ARW-* • **BLP2000BRW-***
BLP3000BRW-* • **BLP3000BRW-***

USER MANUAL

(Note: The "*" represents different AC output socket; for example, "EU" represents European socket; "UK" represents United Kingdom socket; "FR" represents French socket;)

The picture is for reference only, please refer to the actual product, we have the final interpretation of the product.

1 Attention and warning

- Be sure to read this manual carefully before use;
- The machine should be handled with care
- If the equipment is damaged due to failure of installation in accordance with this manual, company reserves the right not to carry out quality assurance.



WARNING

- To prevent fire, do not cover or block the ventilation holes. Do not install inverter in zero clearance compartments, which may cause overheating.
- The machine itself has overload protection to prevent overload. Do not operate or install on a flammable surface. Reverse polarity can damage the device.
- To avoid harm to you and others, here we list all precautions as below, please be sure to follow, please refer to the description for the meaning of various signs.



Caution the surface with high temperature Attention surface a haute temperature.



Flammable gas

Sparks when connecting the battery, before connecting, make sure there is no flammable gas. The battery will be easy to emit flammable gas while charging and discharging. Requesting well ventilation, do not put it in the places which will accumulate flammable gas.



Prohibition in parallel with city power

The output can not be connected in parallel with the mains, which will damage the inverter and cause the electric shock.



Prohibition of minors

Can not be used by minors, inverter has a high voltage output, which may lead risk of electric shock.



No disassembly

Do not disassemble or modify this inverter. Unauthorized disassembly or modification may cause malfunction, and security incidents such as fire disasters or electric shocks.



Prohibition contact with sticks

Do not place a stick or other metal object in the inverter hole or jack, which may touch internal parts to cause electric shock and damage to the inverter.



Do not touch with wet hands

Do not touch the inverter body and the plug with wet hands, this may cause electric shock and personal safety.



Keep away from flames and high temperature area

Operating in flame and high temperature area, may lead inverters and batteries to occur fire or explosion.



No collision

Crashing the inverter will cause the damage and other safety risks.



Prohibition for medical devices

The inverter can not be used for medical equipment before testing.



Ground wire connection

For electricity safety, please connect the inverter to ground, or may cause a safety accident.



Moisture proof and waterproof

Please pay attention to moisture and water proof, inverter may cause short circuit, fire and electric shock because of moisture or water.

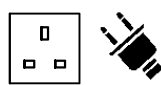

Complete insertion

Please insert the load device plug into the inverter socket completely. If the plug is not fully inserted at the end, it may lead to electric shock and overheating, and even cause a fire accident. Do not use damaged plugs, power outlets, electrical wires.

2 Product Description

Thank you very much for choosing our products and thanks for your trust and support. At present, our products have gotten Chinese and foreign customer's consistent praise. We sincerely hope that this product can meet your needs, at the same time, we hope that you can give more advices about the performance and function of our product, we will continue to improve the quality of our products. Should you have any abnormalities during use, please contact us immediately, we will provide the fastest service for your satisfaction.

BLP series, the remote controlled intelligent inverter, is a newest power solution developed by our company for complex power demand, as users in the digital age have a higher demand for efficiency and flexibility. User-friendly design, innovation and fashion elements of BLP series inverters enable us to seamlessly experience in complex application loads and perfect solution of security, reliability, plug-and-play.

BLP series inverter is a kind of power device that converts direct current (battery, solar cell, wind turbine, etc.) to alternating current. This series of inverters can be used for home, outdoor, car, boat and other environments. The inverter uses a wired remote control display panel to show the working status of the inverter and turn on/off function. The inverter function can be set through display control panel button on the host, to meet the needs of different user.

Remotely controllable multi-function intelligent inverter

- Support wired remote control
- High conversion efficiency
- Multiple protection functions
- Adjustable parameters
- Multiple output interface
- Plug and play
- Full metal casing
- Intelligent cooling fan

Provide input DC12V/24V, output AC100V/AC110V/115V/120V

A variety of power 1000W / 2000W / 3000W

A variety of combinations for your choice



Power supply for vehicle equipment



Solar / Home power generation



power supply for ship equipment

3 Inverter application

3.1 The inverters of BLP series can be the core component of the solar off grid power generation system as well as the independent power supply system.

Off-grid solar power generation system configuration diagram

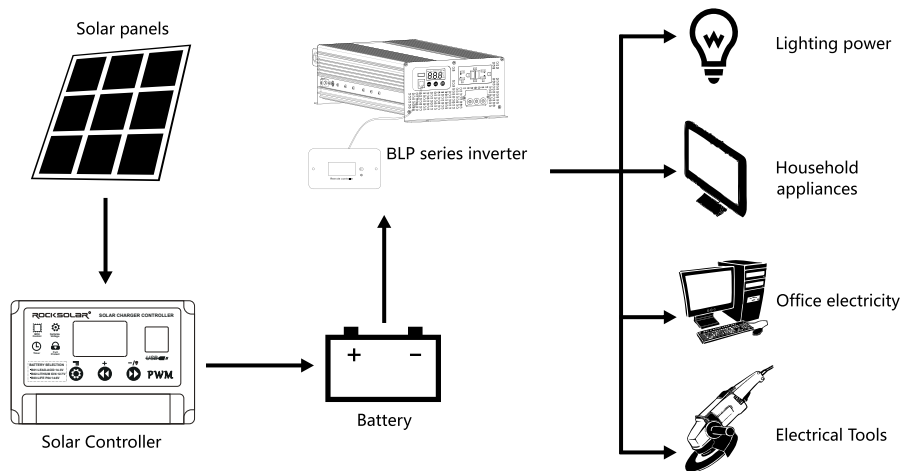

Inverter, solar controller, solar panel, battery can form a set of off-grid solar power generation systems.

Inverter independent power supply configuration diagram

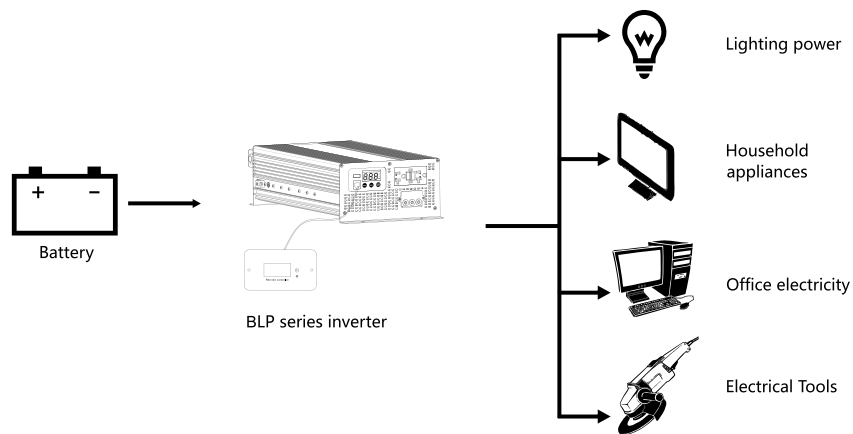

The inverter and the battery can form an independent power supply system, the loaded equipment and the time of use depend on the inverter output power and battery capacity. The inverter can not charge the battery. If you need to charge the battery, please purchase a charger separately.

3.2 BLP series pure sine wave inverter can be used for home, office, car, boat and outdoor emergency power supply, can be used in the following types electrical appliances:

1. household appliances: TV, speakers, amplifiers, refrigerators, air conditioners, electric fans, induction cookers, microwave ovens, electric ovens, consumer ,poison cabinets, hair dryers, electric heaters, vacuum cleaners, fruit oars, rice cookers, water heaters...
2. Office equipment: computers, printers, copiers, network equipment, projectors.
3. Lighting equipment: LED lights, white lights, fluorescent lights, energy-saving lamps.
4. Power tools: electric drills, cutting machines, fans, pumps, hand grinders.



Scope of application

Rated current and actual equipment

The BLP series inverter is a pure sine wave inverter, and its output waveform is the same as mains. The nominal current or power of most electric tools, household appliances, and audio-visual equipment is within the nominal power range of the inverter, but there will an overload protection when starting some electrical equipment.

Some audio and video equipment and electric tools have to be more than resistive load level of power for working preper, asynchronous motors, CRT TV, compressor, water pump, etc. request 2 to 6 times of working current when starting. Weather it can run depends on the test.

This series of inverters CAN NOT be used for medical equipment.

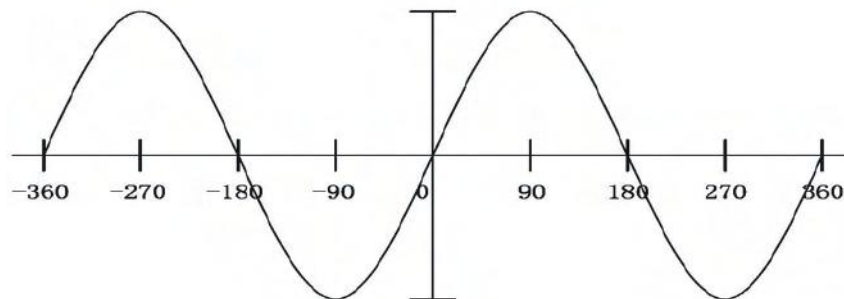

Pure sine wave working diagram

4 Appearance

4.1 Product Size

BLP1000ARW-*/BLP1000BRW-* Product Size

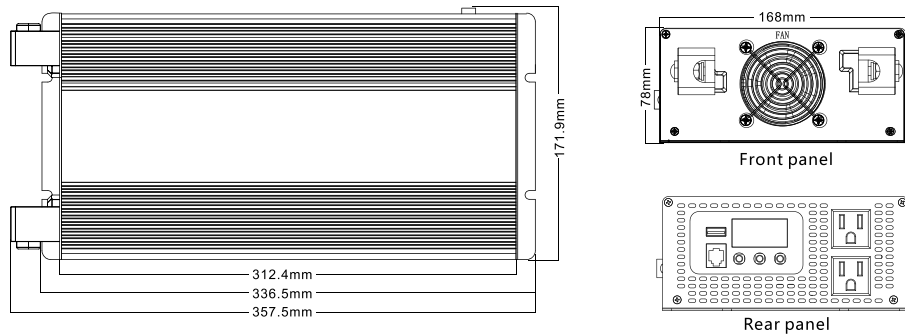

BLP2000ARW-*/BLP2000BRW-* Product Size

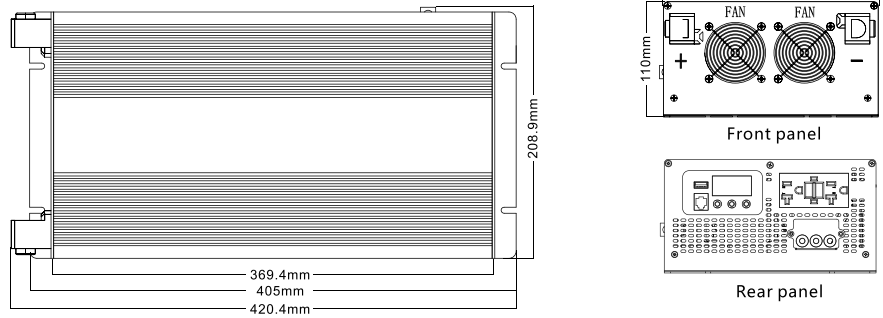

BLP3000ARW-*/BLP3000BRW-* Product Size

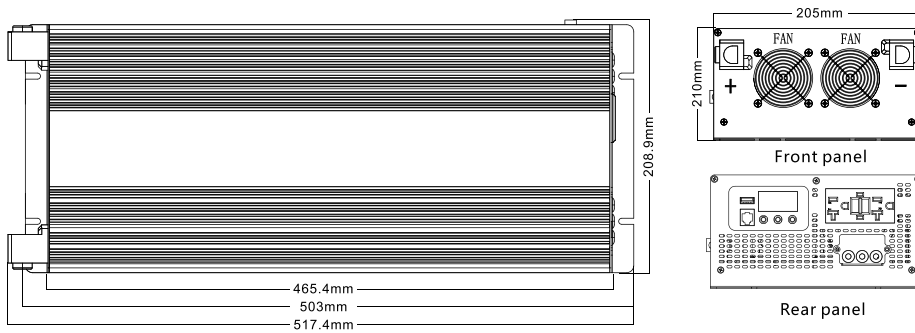

4.2 Appearance diagram

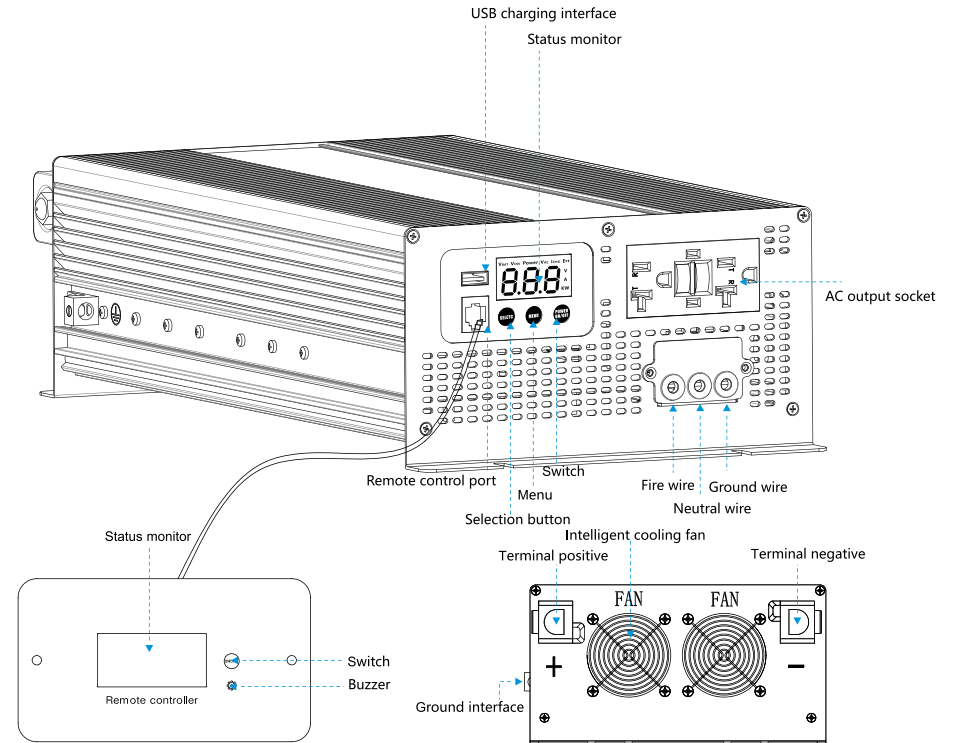

American standard regular socket and American standard GFCI socket

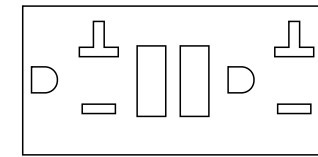
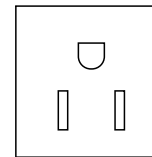

5 Product installation

5.1 Product Installation

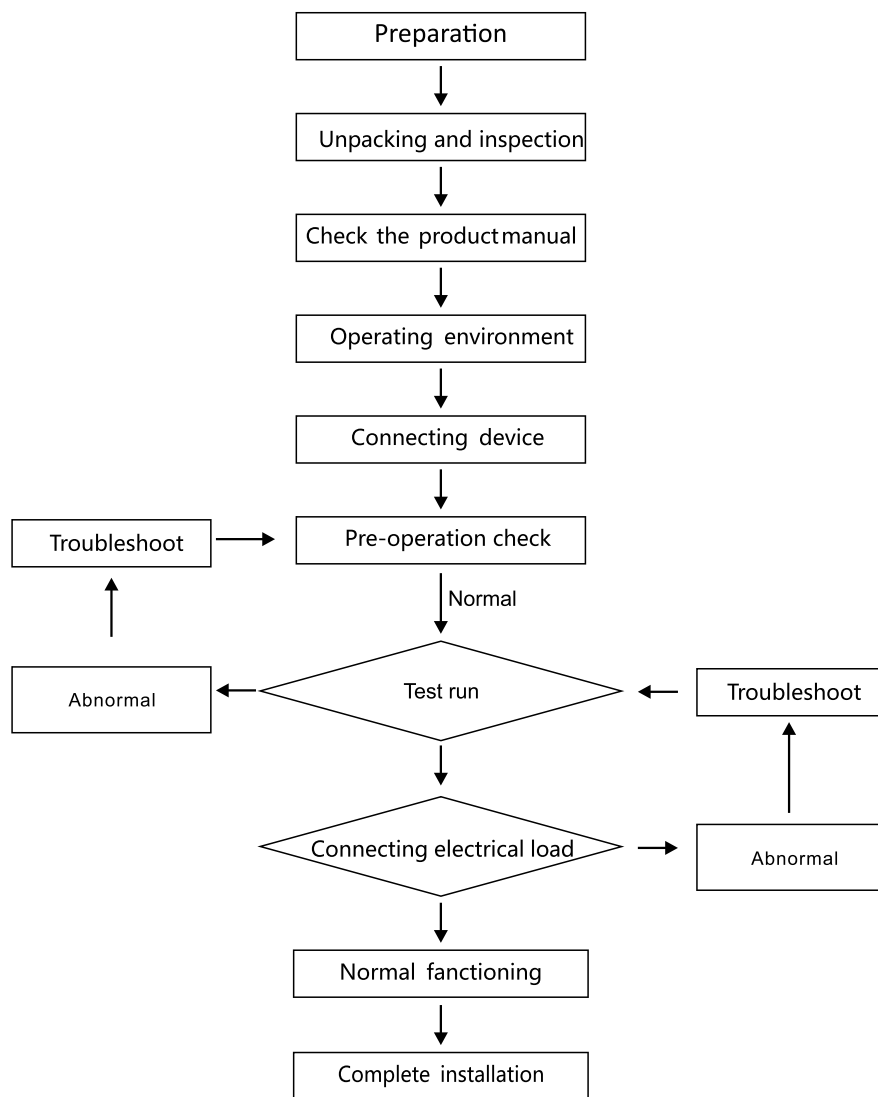

Production installation flowchart

5.2 Unpacking inspection

Please check the body if any damage when unpacking and contact the supplier immediately if the machine is obviously deformed. Please check the label of the device to confirm if the model, input power, input voltage, and output voltage meet the requirements of your purchase. You can confirm the appearance, structure and model refer to the specification. If any missing parts or damage in transportation, please contact our after-sales department in time and keep the packaging materials for future transportation.

5.3 Check the product manual

In order to ensure the product to work normally, please check the manual carefully before using and keep it properly.

5.4 Operating environment

In order to ensure the perfect performance and long lifespan of the product, the installation location of the inverter should be protected from the following conditions,

1. This product should be placed indoors and well ventilated;
2. Avoid using in direct sunlight, exposure, rain, high humidity, corrosive gas and mechanical shock;
3. Working temperature/humidity is -20~40°C/10-90%RH, no condensation. Storage temperature/ humidity -30-60 ° C / 10-95% RH;
4. The package drop test follows the IATA standard.

5.5 Operation equipment connection

5.5.1 Connection diagram

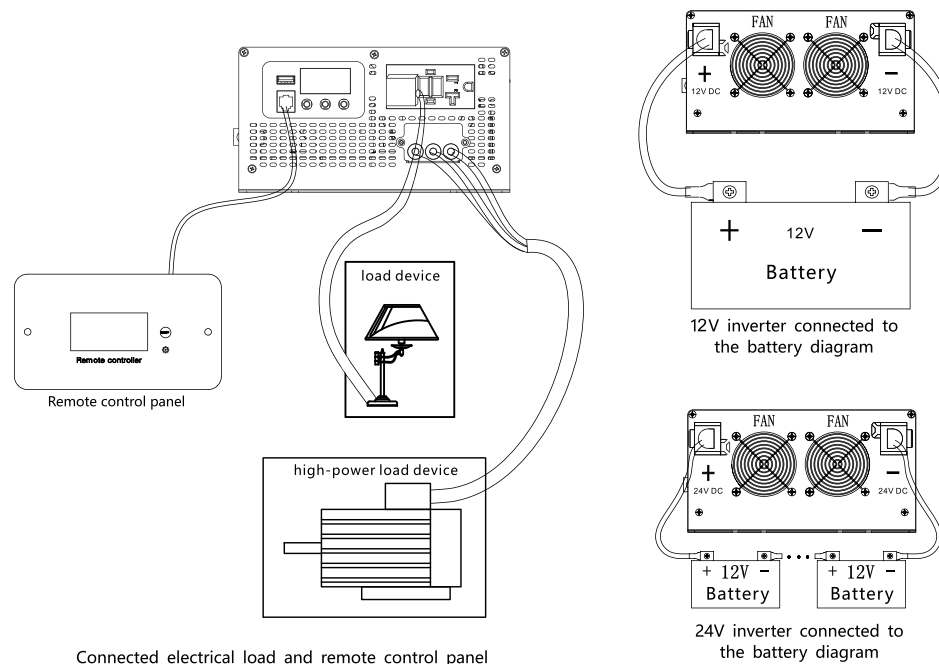

Connected electrical load and remote control panel

5.5.2 Installation and connection steps, refer to the connection diagram

1. Connect the negative pole of the battery to the black terminal of the inverter with a black cable;
2. Connect the positive pole of the battery to the red terminal of the inverter with a red cable;
3. Connect the remote control panel to the remote output interface of the inverter;
4. Turn on the power switch of the inverter;
5. Connect the power plug of the loaded equipment to the output socket of the inverter.

5.5.3 Removal steps:

1. Turn off the power switch of the inverter;
2. Remove the remote control panel.
3. Unplug the power plug of the load.
4. Remove the battery positive cable;
5. Remove the battery negative cable;

Warnings

1. The wiring diagram is only for basic reference. Please contact a professional technician for actual installation.
2. Inverter must be connected to the battery, same as nominal voltage, 12V inverter connects 12V battery and 24V inverter connects 24V battery;
3. Appropriate cable should be used when installing and connecting output cables, such as 110V output cable is too long or the cross-sectional area of the wire when it is too small, it will generate a lot of power loss on the cable, 1000W load uses cable ≥ 16 AWG, 2000W load use cable ≥ 14 AWG, 3000W load ≥ 12 AWG.
4. The connection cable between the battery and the inverter is not standard, like overlength cable, too small cross-sectional area and poor contact in connection, it may cause lots of power loss, performance as insufficient output power, low battery voltage, short working time, even not working with alarm when turn on. At the same time, the cable should have waterproof function and insulation strength to meet the requirements of the use environment.
5. When choosing a battery for the inverter, it is better to choose a battery with 100AH or larger capacity.

5.5.4 Installation guide

1. Whether you buy the wire from the original factory or use your own one, the wires must have the copper wire with enough carrying.
2. The wire is connected from the battery to the fuse and then to the host, the fuse will provide the insurance in case of fault. If using isolation switch, make sure the fuse rating matching the host power.
3. For ships or vehicles, it is recommended to use multiple AC flexible cables.

5.5.5 Remote control installation

When the inverter host is closed, connecting one end of the communication line with a magnetic ring to the inverter host, and the other end to the wiring port of the remote panel.

5.5.6 Installation dimension drawing

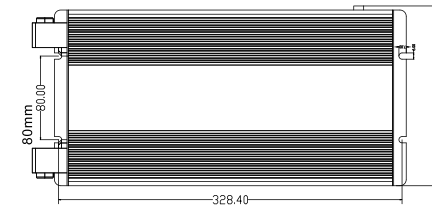

BLP1000ARW-*/BLP1000BRW-* Inverter installation size

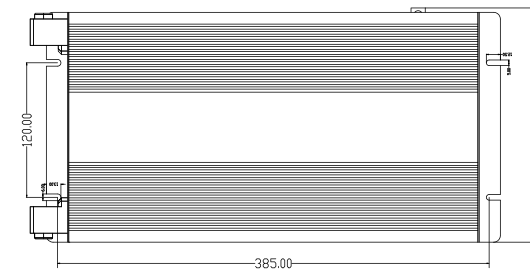

BLP2000ARW-*/BLP2000BRW-* Inverter installation size

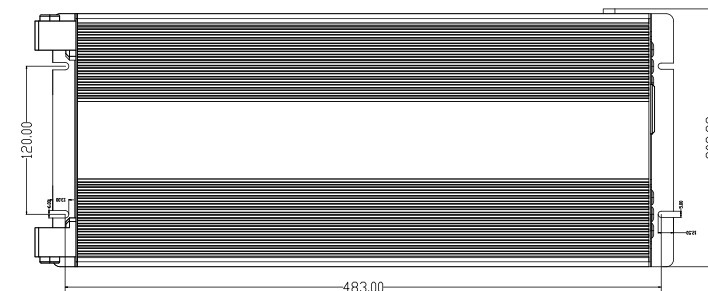

BLP3000ARW-*/BLP3000BRW-* Inverter installation size

6 Product parameter list

Model		BLP1000ARW-*	BLP2000ARW-*	BLP3000ARW-*	BLP1000BRW-*	BLP2000BRW-*	BLP3000BRW-*
Output	Rated Power	1000W (30 minutes) 900W (continuous)	2000W (30 minutes) 1800W (continuous)	3000W (30 minutes) 2700W (continuous)	1000W	2000W	3000W
	AC Voltage	100V/110V/115V/120V					
	Frequency	50Hz/60Hz(Adjustable)					
	Peak Power	2000W	4000W	6000W	2000W	4000W	6000W
	Total Harmonic Distortion(THD)	≤5					
Input	Battery Voltage	12V			24V		
	Voltage Range	9V-17V			18V-32V		
	DC Current	96A	194A	291A	46A	92A	139A
	No load Consumption	1.2A	1.5A	2A	0.6A	0.7A	1.1A
	Quiescent Current in Shutdown Mode	1mA			1mA	1mA	1mA
	Max Efficiency(full load)	90%			91%		
	Battery Type	lithium battery, lead acid battery, valve control battery and gel battery;					
Battery input protection	Fuse	35A*4	300A*1	400A*1	40A*2	150A*1	200A*1
	Low Battery Alarm	9.5/10/10.5/11/11.5/12/12.5V, Buzzer alarm, E06 in LED monitor			19/20/21/22/23/24/25V, Buzzer alarm, E06 in LED monitor		
	Recovery of Battery Low Voltage Alarm	10/10.5/11/11.5/12/12.5/13V			20/21/22/23/24/25/26V		
	Low voltage Protection	9/9.5/10/10.5/11/11.5/12V(Adjustable), E01 in LED monitor, inverter will turn off automatically in 30S			18/19/20/21/22/23/24V(Adjustable), E01 in LED monitor, inverter will turn off automatically in 30S		
	Recovery of Low Voltage Protection	Recovery in 30S:11/11.5/12/12.5/13/13.5/14V			Recovery in 30S:22/23/24/25/26/27/28V		
	High Voltage Protection	17V, E02 in LED monitor, inverter will turn off automatically in 30S			32V, E02 in LED monitor, inverter will turn off automatically in 30S		
	Recovery of High Voltage Protection	Recovery in 30S: 16.5V			Recovery in 30S: 31V		
	Battery reverse connection protection	When input DC polarity is connected reversely, the fuse will blow to protect the parts of the inverter from being damaged					
	Output protection	High Temperature Alarm	Buzzer alarm, E07 in LED monitor				
Over Temperature		Buzzer alarm, inverter stops working with E04 in LED monitor, recovery after temperature reduction					
Short Circuit		Short circuit protection is locked, buzzer alarm, E03 in LED monitor, inverter will turn off automatically in 30S					
Over Load Alarm		Buzzer alarm, E08 in LED monitor					
Overload Alarm		Buzzer alarm, E05 in LED monitor, inverter will turn off automatically in 30S					
USB	Single USB output Voltage	5V/ 9V					
	Single USB output Current	2.1A					
Working environment	Cooling Method	Internal fan of the machine					
	Working Temperature	-20-40°C					
	Working Humidity	10-90%RH					
	Storage Temperature/Humidity	-30°C-+70°C, 10-95%RH					
Packing	N.W.	2820g	5010g	6640g	2820g	5010g	6640g
	Size/mm (L×W×H)	357.5*172*78	420.4*208.9*110	517.4*208.9*110	357.5*172*78	420.4*208.9*110	517.4*208.9*110
Remark	All the parameters are measured in environment temperature 25°C if not specified.						

7 Display function

7.1 Host display: three-digit LED seven-segment digital tube for display

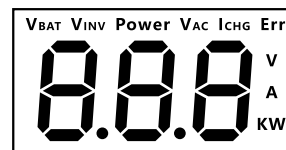

VBAT: When VBAT is lit, it indicates DC input voltage.

VINV: When VINV is lit, it indicates the inverter output voltage.

POWER: When the POWER is lit, it indicates the inverter output power.

VAC: This machine does not have this feature.

ICHG: This machine does not have this feature.

ERR: When ERR is lit, it indicates that the inverter has a fault or warning.

You can check the fault information through the error code of the digital display tube.

7.2 Inverter fault and removal method

Error code	Malfunction	Fault description	Method of exclusion
E01	Battery low voltage protection	The battery voltage is too low and the inverter automatically turns off the output.	Check if the battery cable is loose or check if the battery capacity is too small
E02	Battery High Voltage Protection	The battery voltage is too high and the inverter automatically turns off the output.	Check the battery voltage or determine if there is an external charger connection that causes the voltage to be too high
E03	Inverter Output Short-circuit Protection	Inverter output short circuit, inverter automatically closes output	Check if the AC output cable is shorted. Disconnect or reduce the electrical load and turn the inverter back on
E04	Inverter Over Temperature Protection	The internal temperature of the machine is too high and the inverter automatically turns off the output.	Check if the ventilation of the machine is good and the working environment temperature is too high. Wait for the machine to automatically cool down and automatically restore the output.
E05	Inverter Overload Protection	The inverter output is overloaded and the inverter automatically turns off the output.	Check if the power load is too large, disconnect or reduce the power load, and turn the inverter back on.
E06	Battery Low Voltage Alarm	Low battery voltage, machine alarm	Turn off the load and charge the battery
E07	Inverter Over Temperature Alarm	The internal temperature of the machine is too high, close to the limit of the machine	Reduce the electrical load and check if the machine is well ventilated and the ambient temperature is too high.
E08	Inverter Overload Alarm	The power load is too large, close to the limit of the machine	Reduce the electrical load
E09	Inverter Output Over Voltage Protection	Inverter output voltage is too high	Disconnect the power load, turn the machine back on, and check if the machine is normal.

7.3 Wired remote control panel with LCD display

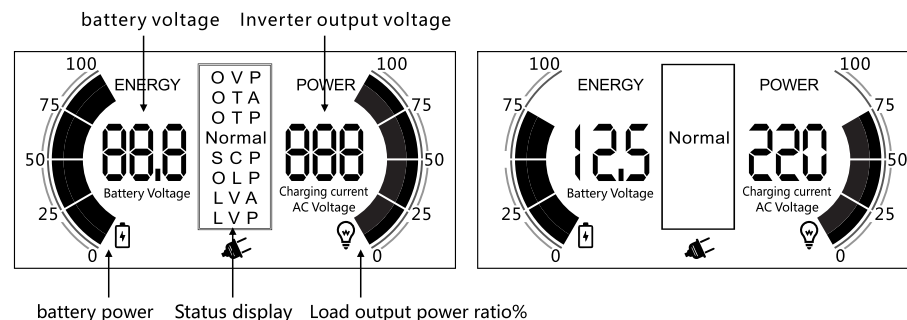

8 Display and Control panel

The display panel can be operated remotely via a 6pin telephone line with a short distance of up to 7 meters.

8.1 Keystroke tone:

Press the Power, Select, Menu button at any time, and the buzzer will emit a short beep.

8.2 Inverter On/Off:

Turn the inverter on/off, and press the power button on the display panel for about 1 second and hear the beeped sound.

8.3 Three LED seven-segment digital tube for display:

- When the inverter is working, the LED digital screen alternately displays: "battery voltage", "inverter output voltage", "inverter output power"
- When the inverter fails, the LED digital screen displays the corresponding error code.

8.4 Press the button 'Menu' to view the current inverter display status:

- When the DC input voltage is displayed, the LED screen displays 'VBAT', and the three-segment digital tube displays: '**.*V
- When the AC output voltage, the LED screen displays 'VINV', the three-segment digital tube displays: '****V
- When the inverter AC output power, the LED screen displays 'Power', the three-segment digital tube displays: '*.*KW

8.5 Press the button 'Select' to view the current inverter settings status:

- View inverter output frequency setting LED screen display: '50: output frequency 50HZ/'60: output frequency 60HZ'
- When viewing the inverter function low voltage protection setting, the LED display shows: '9', '9.5', '10', '10.5', '11', '11.5', '12' (12V inverter low voltage protection setting) '18', '19', '20', '21', '22', '23', '24' (24V inverter low voltage protection setting)
- When viewing the buzzer alarm on/off function setting, the LED display shows: 'AL0: buzzer off', 'AL1: buzzer on'
- View inverter AC output voltage setting, LED display shows: '100: Inverter output voltage 100VAC', '110: Inverter output voltage 110VAC', '115: Inverter output voltage 115VAC', '120: Inverter output Voltage 120VAC'
- Inverter AC output function setting, LED screen display: 'IN1: Inverter default setting mode', 'IN2: Inverter power saving mode', 'IN3: Inverter automatic shutdown mode'

8.6 Inverter function settings:

- Press the 'menu' button for 5s, and the inverter enters the function setting menu mode:
- LED screen display: 'FE' indicates the frequency setting menu, press 'Select' button 1s to enter the output frequency setting: '50: output frequency rate 50HZ/'60: Output frequency 60HZ', the output frequency can be set by 'Select' button. After the selection is completed, press 'Menu' button 5s, you can save settings and exit the menu setting function; If you need to continue to set other functions, press the 'Menu' button for 1 second to enter the next menu setting. After the next menu is set, press the 'Menu' button for 5s, you can save it together with the last setting, after the save is completed, the menu setting function will be automatically exited.
- LED screen display: 'LV' indicates the battery low voltage protection setting menu, press 'Select' button 1s to select the battery low voltage protection voltage:

'9', '9.5', '10', '10.5', '11', '11.5', '12' (12V inverter low voltage protection setting)

'18', '19', '20', '21', '22', '23', '24' (24V inverter low voltage protection setting)

After the selection is completed, press the 'Menu' button for 5s to save the settings and exit the menu setting function; if you need to continue to set other functions, press the 'Menu' button for 1 second to enter the next menu setting. After the next menu is set, press the 'Menu' button for 5s to save the last set function together. After saving, the menu setting function will be automatically exited.

- LED screen display: 'AL' indicates buzzer alarm setting menu: 'Select' button 1s, select buzzer setting: 'AL0: buzzer off', 'AL1: Buzzer on'; after the selection is completed, press the 'Menu' button for 5s to save the settings and exit the menu setting function; If you need to continue to set other functions, press the 'Menu' button for 1 second to enter the next menu setting. After the next menu is set, press the 'Menu' button for 5s to save the last set function together. After saving, the menu setting function will be automatically exited.
- LED screen display: 'out' indicates the inverter AC output voltage setting menu: press 'Select' button 1s to select inverter AC output voltage setting: '100: Inverter output voltage 100VAC', '110: Inverter output voltage 110VAC', '115: Inverter output voltage 115VAC', '120: Inverter output voltage 120VAC. After the selection is completed, press 'menu' key 5s, you can save settings and exit the menu setting function; If you need to continue to set other functions, press 'Menu' key 1s, will go to the next menu setting. After the next menu is set, press the 'Menu' button for 5s to save the last set function together. After saving, the menu setting function will be automatically exited.
- LED screen display: 'IN' inverter function setting menu: 'Select' key 1s, enter inverter function setting 'IN1: inverter default recognize setting mode', 'IN2': Inverter power saving mode', 'IN3: Inverter automatic shutdown mode'. After the selection is complete, press 'Menu' button 5s, you can save settings and exit the menu setting function; if you need to continue to set other functions, press 'Menu' The key 1s will enter the next menu setting. After the next menu is set, press the 'Menu' button for 5s to save the last setting together. The function will automatically exit the menu setting function after saving.
IN1: Inverter default setting mode; when the inverter is turned on, the inverter continues working unless there is a fault.
IN2: Inverter power saving mode; if the AC power load is less than 10W after the inverter is turned on, the inverter will automatically shut down AC output, until the AC power load is larger than 10W, the inverter automatically turns on the AC output.
IN3: Inverter automatic shutdown mode: if the load power is less than 10W within 30min after the inverter is turned on, the inverter will turn off the AC output and shutdown automatically.
- LED screen display: 'DEF' restores the factory default menu settings. When this mode is set, the factory function settings will be automatically restored: Inverter output frequency: 60HZ, battery low voltage protection voltage: 10V/20v, buzzer alarm: AL1, inverter output voltage: 110V, the inverter function is set to: default mode 'IN1'. Press 'Menu' for 5s to save settings and exit menu setting function; if you need to continue to set other functions, press 'Menu' button 1s, it will enter the next menu setting. In the next menu after setting, press 'Menu' button for 5s to save the last set function together. After saving, it will automatically exit the menu.

8.7 Display and control panel

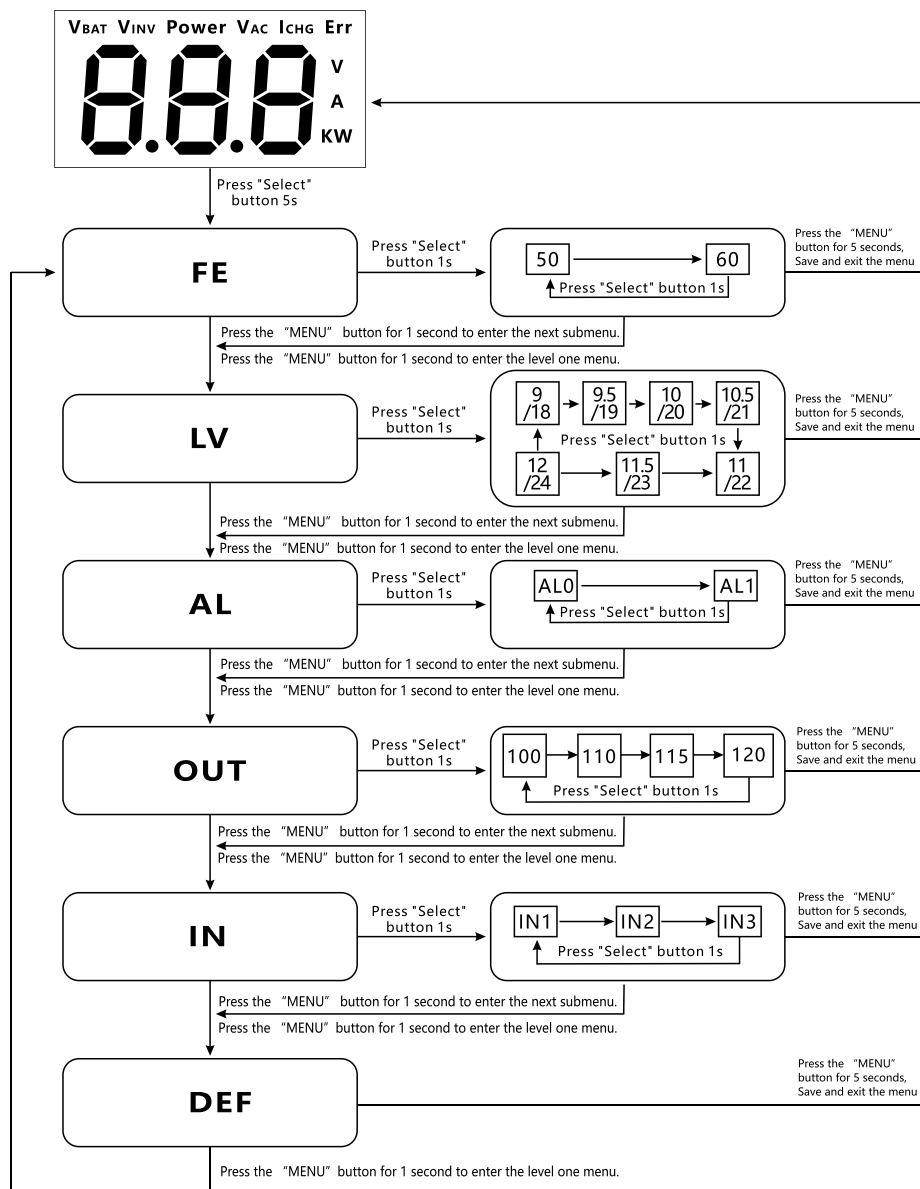

9 Total Harmonic Distortion (THD)

The THD of the output: < 5%

10 General technical requirements

10.1 Operation and storage temperature requirements:

- Normal working temperature: 2 5 °C
- Operating temperature range: -20~ 45°C
- Storage temperature range: - 30~ 60 °C

10.2 Operation and storage humidity requirements

- Normal working humidity range: 1 0 – 90 %RH
- Storage humidity range: 10 – 95 %RH

10.3 Packaging Drop Test Requirements

Packaging drop test follows IATA standards

10.4 Corrosion resistance requirements

All metal parts are treated with oxidation

11 DC input wire requirements

- BLP-3000S-12V-* Wiring: #3/0 AWG (American Standard) or National Standard 80mm² Wire length: 1.5 meters max
- BLP-3000S-24V-* Wiring: #2 AWG (American Standard) or National Standard 30mm² Wire length: 1.5 meters max
- BLP-2000S-12V-* Wiring: #2/0 AWG (American Standard) or National Standard 50mm² Wire length: 1.5 meters max
- BLP-2000S-24V-* Wiring: #2 AWG (American Standard) or national standard 30mm² Wire length: 1.5 meters max
- BLP-1000S-12V -*Wiring: #2 AWG (American Standard)) or national standard 30mm² Wire length: 1.5 meters max
- BLP-1000S-24V-* Wiring: #5 AWG (American Standard) National Standard 16mm² Wire length: 1.5 meters max

12 Product features

- Provide fan with intelligent control to reduce the running noise effectively, high efficiency operation;
- Touch switch;
- Provide remote control by wired control panel;
- Dual frequency setting, which can be switched between 50Hz and 60Hz frequency;
- Adjustable minimum voltage for low voltage protection of the battery;
- Long lifespan in extreme environmental conditions;
- Output voltage AC 100V, AC 110V and AC 115V and AC120V can be set;
- Low no-load current, saving energy without load;
- High load capacity can bear relatively large loads and handle stably in case of overload;
- Support a variety of batteries, battery types such as lithium battery, lead acid battery, valve control battery and gel battery;
- Provide a variety of intelligent protection:
 - 1, battery low voltage protection and alarm
 - 2, battery over voltage protection
 - 3, overload protection and alarm
 - 4, short circuit protection 5, high temperature protection and alarm
- Provide input/output voltage display functions and USB output;
- Plug and play maintenance-free design ensures long-term continuous operation
- This product is made of metal shell, anti-oxidation process, beautiful appearance.

ROCKSOLAR[®]

Keeper SERIES

Maximum Power Point Tracking Solar Charge Controller

MPPT 20A-60A



CONTENTS

1.OVERVIEW.....	1
2.PRODUCT APPEARANCE.....	2
3.WIRING.....	3
4.DESCRPTION.....	4
5.INSTALLATION IMPORTANT NOTE.....	5
6.OPERATION STEPS.....	6
7.COMMON FAULT.....	11
8.TECHNICAL SPECIFICATIONS.....	12

1. OVERVIEW:

Thank you for selecting MPPT series solar charge controller with the most advanced MPPT control algorithm and the maximum power point of the pv array can be quickly tracked in any environment so that it can get the maximum energy from the solar panel and significantly improve the utilization of energy in solar system. The machine has the dual display function of LCD and Remote header (optional) and standard communication interface, convenient for user extension application and satisfy different monitoring needs to the maximum extent. It can be used in communication base station, home power supply system, traffic light, solar street lamp, courtyard lamp system, etc. The

- Advanced MPPT maximum power point tracking technology, the tracking efficiency is no less than 99.5%.
- High quality components are used to improve the system performance, and the maximum conversion efficiency can reach 97%.
- Super fast maximum power tracking speed while ensuring tracking efficiency.
- Accurate identification and tracking of the maximum power point of multi-wave peak.
- Reliable maximum input power of pv array to ensure the safety of equipment.
- Wide pv array maximum power point operating voltage range. 12/24v automatic voltage identification
- The LCD is designed to dynamically display the operation data and working status of the equipment.
- Various load control modes: general mode, light control mode, dual time mode, pure charger mode and timing mode.
- Seal, GEL, Flooded, LifePO4 and Li (NiCoMn) O2 charging process can be selected.
- The function of battery temperature compensation.
- Power statistics recording function.
- Additional customization required, Support PC monitor, external display unit and other peripherals, realize real-time data view and parameter setting function
- Additional customization required, Use the RS485 methods to maximize the communication needs of different occasions

3. WIRING

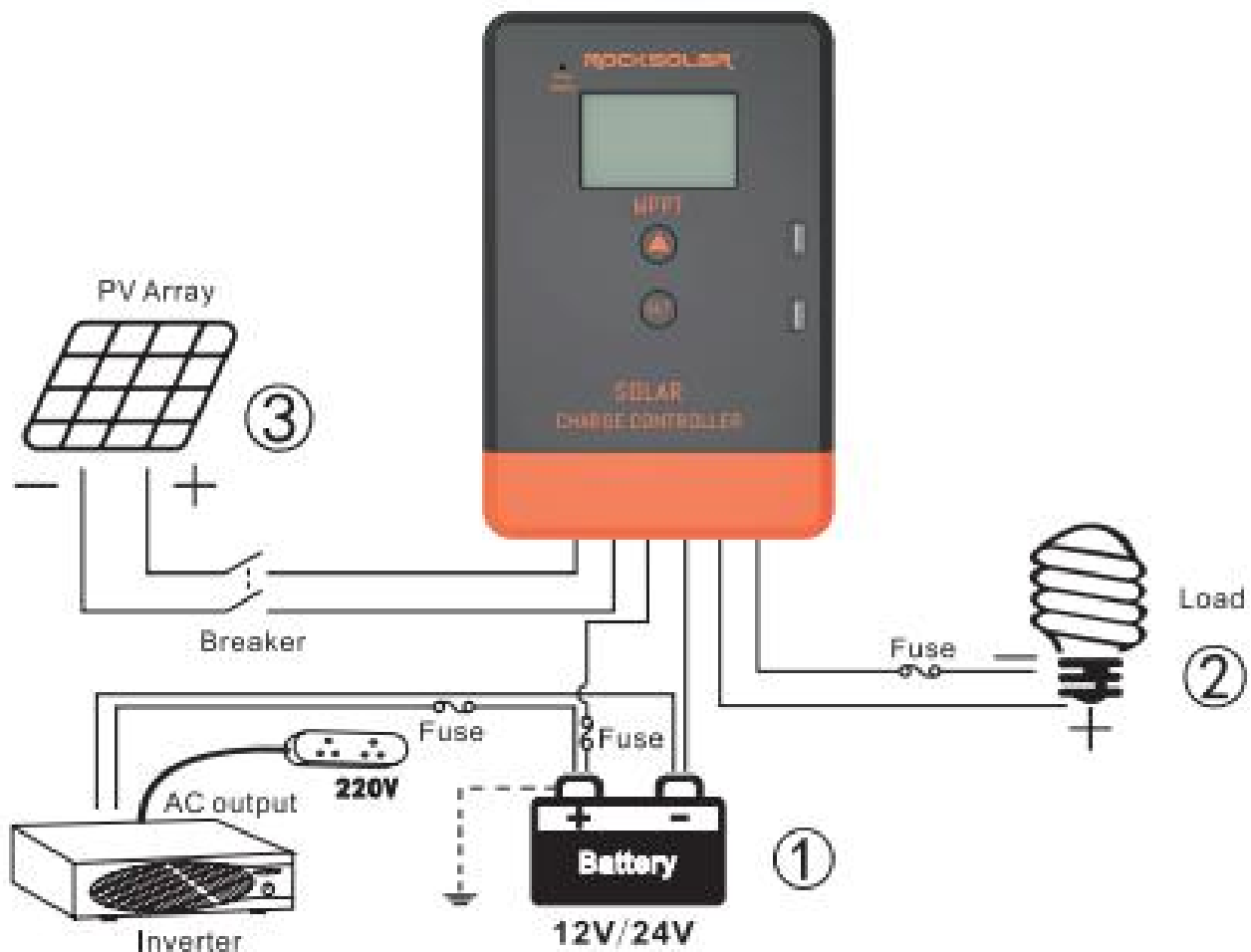

Photo 2 Connection diagram

Order of connection:

① Connect battery

Notice: The battery terminal shall be installed with insurance, and the installation distance shall not exceed 50mm.

② Connected Load

③ Connect pv array

④ Controller is powered on

Connect the battery, identify the voltage of the control system and observe whether the display screen is lighted. If it doesn't work or the display is abnormal, refer to section 6 for troubleshooting.



NOTICE: This series of MPPT is a common positive: controller, pv array, battery and load of the positive pole can be grounded at the same time.



NOTICE: If the inverter or other starting current is loaded. Sin the system, please connect the inverter directly to the battery. Do not connect with the controller's load terminal.

4. DESCRIPTION

4.1 Buttons

Mode	Remarks
load switch	When the load is manual mode, by short pressing set button can switch the load.
Breakdown	Pressing the set button shortly
Browse mode	Pressing the menu or set button shortly
Setting mode	Long press menu button enter the secondary browsing interface and then press menu or set button to browse interface, long press menu again to enter the setting mode, short press menu or set button to set parameters then long press menu button to save the setting Long press set button or 20s without keystroke operation will exit secondary browsing interface (parameter not saved)

4.2 LCD

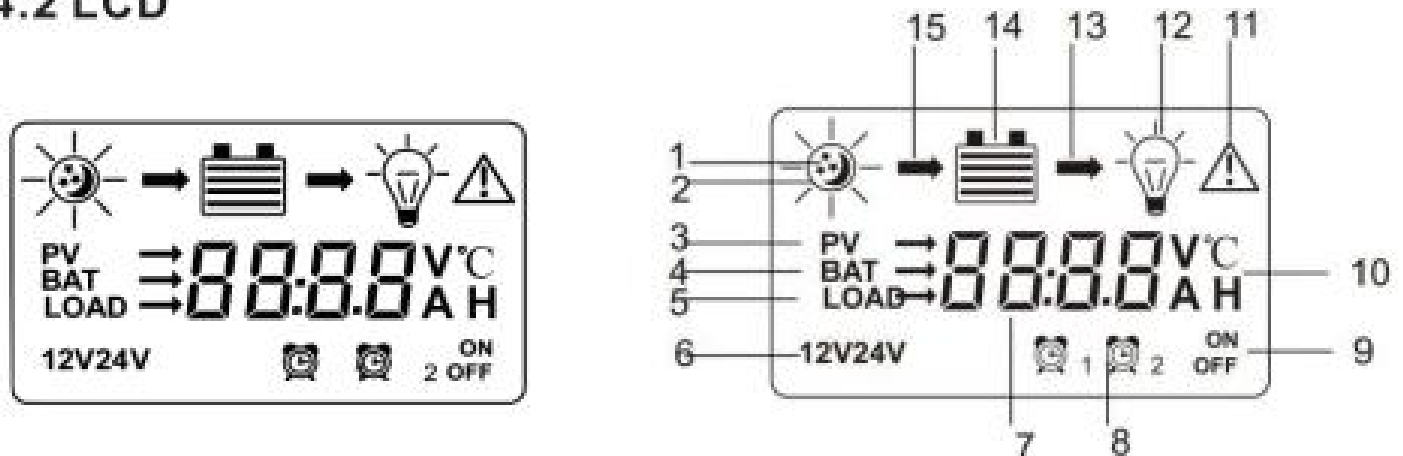

1. The default night display of controller:
When the solar panel input voltage have been detected by controller less than sensor identification point voltage, this graphic symbol will be light.
2. The default daytime display of controller:
When the solar panel input voltage have been detected by controller more than sensor identification point voltage, this graphic symbol will be light.

3. The indicator of PV array parameter:
When the solar panels data was displaying, this graphic symbol will be light, for example the voltage of solar panel.
4. The indicator of battery parameter: When the battery parameter was displaying, this graphic symbol will be light, for example the voltage of battery, temperature of battery
5. The indicator of load parameter:
When the load parameter was displaying, this graphic symbol will be light.
6. System voltage:
When the LCD shows different system voltage, controller will adjust the technical data automatically.
7. Numerical display area
8. Timer setting function
9. Switch graphic symbol
10. Unit symbol value
11. Warning:
When there is fault, this graphic symbol will be light.
12. The indicator of load status:
Load on, Load off.
13. The indicator of output power:
When the load terminal have output, this graphic symbol will be light.
14. The indicator of capacity of battery:
When the battery was in different capacity, the strip-type will show.
15. The indicator of charge status:
When the controller is charging, the symbol will be light, float charge will be flash, no charging no display.

5. INSTALLATION IMPORTANT NOTE

- 1) The controller should be installed well-ventilated place, avoid direct sunlight, high temperature and do not install in location where water can enter the controller.
- 2) Please select correct screw to fix the controller on the wall or other platform. Screw M4 or M5, screw cap diameter less than 10mm
- 3) Please reserve enough space between the wall and controller, to allow for cooling and cable connection.
- 4) Connect components to the charge controller in the sequence, please pay much attention to the positive" and "negative", don't insert the fuse or turn on the breaker during the installation. When disconnecting the system, the order will be reserved.

- 5) Always connect the battery first, in order to allow the controller recognize the system voltage.
- 6) The battery fuse should be installed as close to battery as possible.
- 7) The distance between the battery fuse to battery group is within 150mm
- 8) Positive grounding controller, any positive connection of solar load or battery can be earth grounded as required.
- 9) All terminals are in tight status after leaving factory, in order to well connected, please loose all terminals at first.
- 10) The sequence of connection please do not free change, otherwise cause system voltage recognition fault.
- 11) The length of cable between battery and controller as shorter as possible. Suggest 30cm to 100cm.
- 12) If short circuit happened on the terminals of controller, it will be result in fire or explode. Please be careful. (We strongly suggest to connecting a fuse at the battery side 1.5 time of rated current of controller)
- 13) If the battery reverse connection, the output of controller also same with battery polarity, please do not connect any load with controller at that time, or the load and controller will be destroyed.
- 14) The voltage of solar panel is very high under sunshine, high voltage can cause injury or destroy controller, make sure PVmax under required safety MPP range.
- 15) Avoiding injury from load voltage, please close to the output of controller with button at first, then connected the load on the controller. The controller do not offer reverse connection protection for load, so please take care, reverse connection for load will be destroy bulb.

6. OPERATION STEPS

Main interface

- 1) The controller will have 1s initialization interface after electrified, then go into main interface.

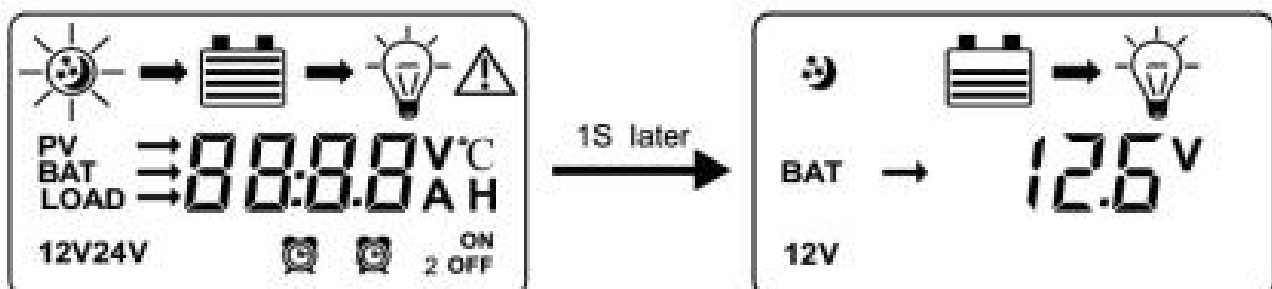

2) If no operation at main interface inner 20s, the main interface will be auto exchange during voltage of battery, voltage of solar panel, temperature of environment, each interface keep 3s. Long press "set" more than 5s at main interface, it will speed auto exchange. Loose button will stop speed.

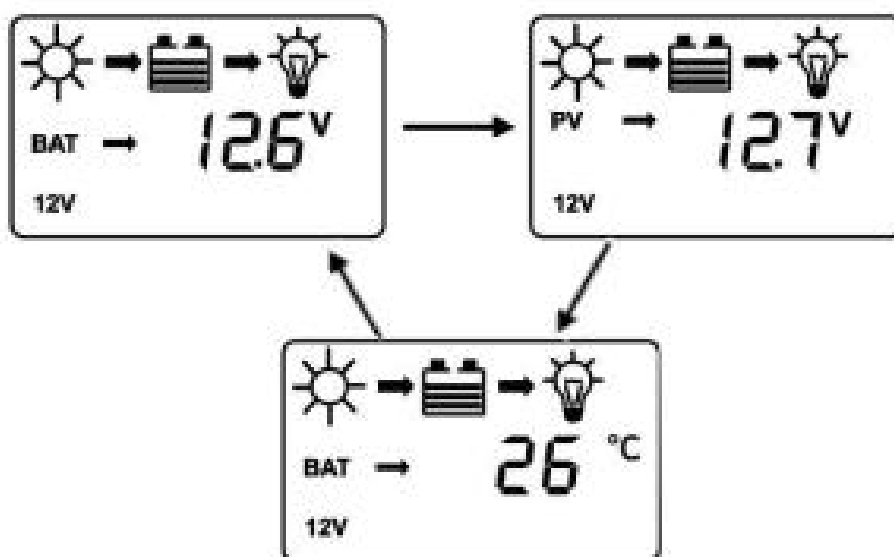

3) Press "set" under main interface could open or close

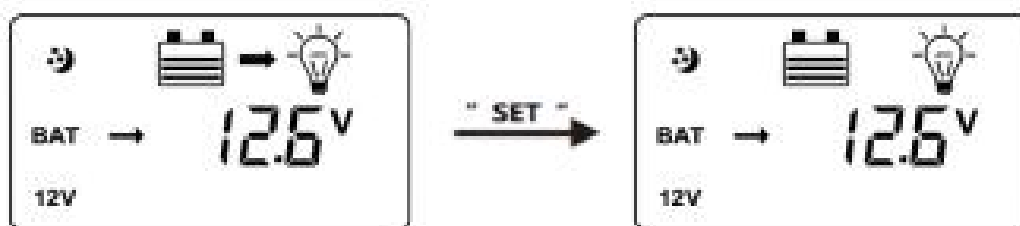

4) Press "menu" button could join into next menu under main interface.

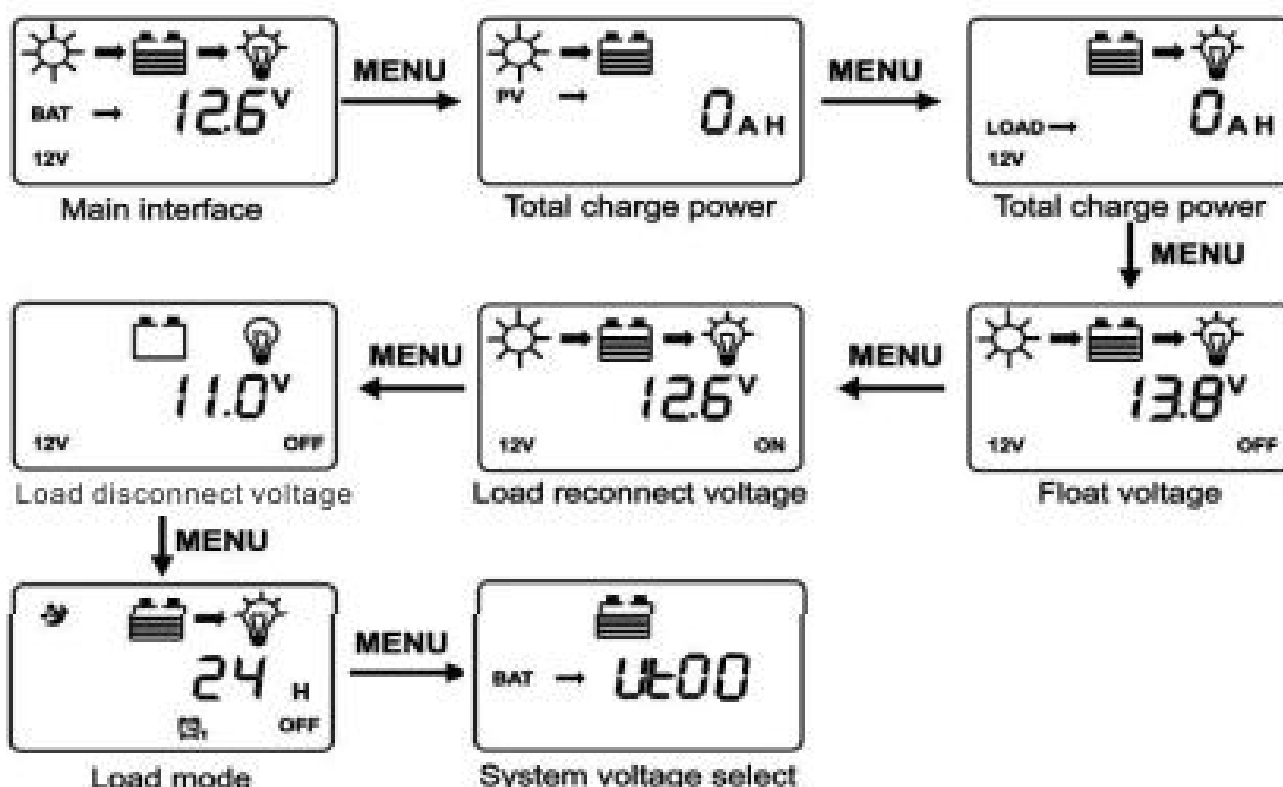

a) Float voltage set up

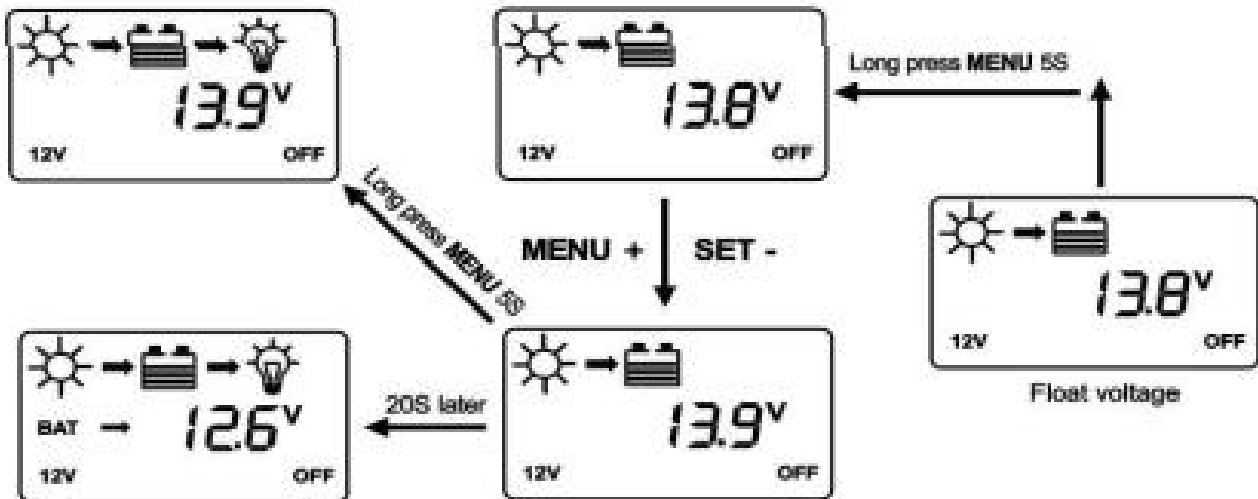

This parameter is high voltage disconnection (HVD) voltage. (Boost state voltage will be increase 0.6V base on HVD). The controller will be started PWM function at this point (HVD), limited voltage rising.

Press "menu" button join in float voltage menu.

Long press "menu" button more than 5s, the parameter on the interface will be flash, here is set up state. Loose the button, press "menu" button again could operate plus data, press "set" button could operate minus data. After finish required technical data, long press "menu" button again more than 5s, the parameter save and come out set up state, if 20s no any operation, automatically back to main interface.

b) Low Voltage Reconnect Voltage (LVR)

When the voltage of battery is low, the control will stop offer power to the load. If the controller needs reconnected the output, the voltage of battery must be higher than LVD voltage or press "set" button force to release. The procedure is same with (a).



c) Low Voltage Disconnect Voltage (LVD)

When the voltage of battery is low, the load output will be cut off. When the controller detected the battery voltage was less than LVD point, the cut off function will be immediately working. At the same time, the status of controller is in lock. Users have to charge the battery, when the battery voltage is higher than LVD voltage or press "set" button force to release. The load output will be back. The procedure is same with (a).

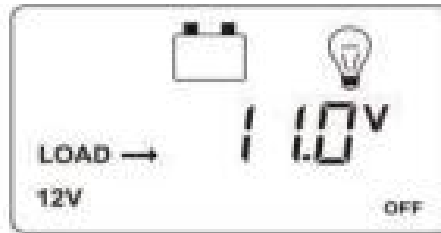

▲ Above a, b, c three parameter default data was fully considered by designer according to the actual use. Generally users don't need to adjust. Please must be refer to battery supplier's suggestion, or the battery will be damaged or irreparable destroy.

d) Load Working Mode Selection

The control default load working 24hours. When the load working time set to 24hours, the load will keep working 24hours in no fault status. When the load working time set to less than 23Hours, it means the load start timer or sensor function. If the battery capacity is enough, the load will be started at sunset. The load will work under timer setting hours or stop working till sunrise.



Load mode

- ▲ When the load join into timer or sensor mode, if the reset working time more than actual night time, the load output will be closed at sunrise, although the working time is not reach to setting hours, for example, the local actual night time is 10hours, user reset the working time at night is 12hours, but 10hours later the output will be closed automatically, the balance hours will be back to zero. The load will be working with next sunset signal.

e) System Voltage Select

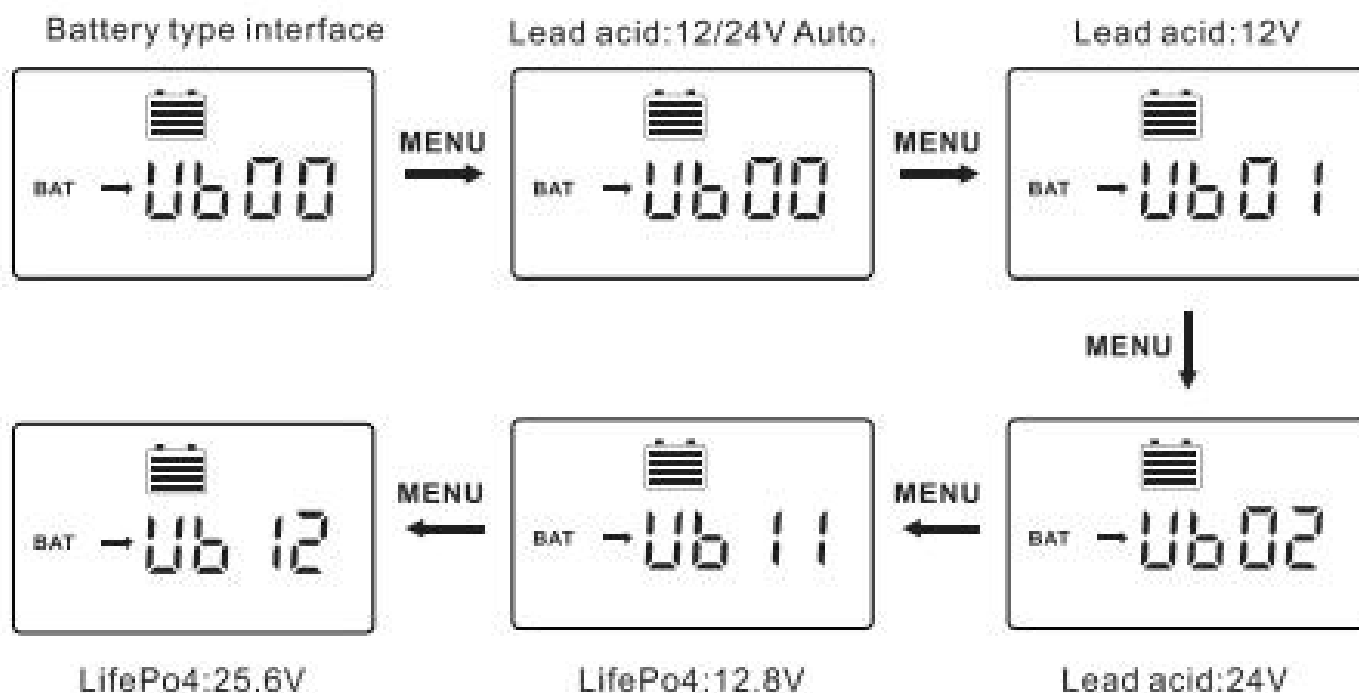

7. COMMON FAULT

Cause	Correction
Solar panel is disconnected	Check if connection of solar input is right and contact is reliable.
1. Battery voltage is less than 8V 2. Voltage of solar panel is less than battery voltage	1. Check battery voltage. Controller will start only Battery voltage is more than 8V 2. Voltage of solar panel must be more than battery voltage.
Battery Over-discharge	Load Output is turned off automatically and recovers when battery electricity is enough
Overvoltage of storage battery	Please check whether the battery voltage exceeds the voltage and reconnect the solar panel.
Over-load	Reduce load or check load connection
Over temperature	Make the controller cool down and restart charging automatically
Charging current of solar panel is too large	Check power of solar panel and reduce quantities of solar panel in parallel; Restart after 2 minutes.
The Controller display LVD	The battery is over discharge, check the system designs reasonable or not, there is discharging capacity more than charging capacity
The Controller display HVD	The voltage of battery is high, Cut off the solar panel and see if the voltage got down normal, if the fault still then cut off the battery and reconnect it again
The controller display OCP Over current protection	The load is short circuit or over load or high surge power check the load cables have short circuit, the power of the load over rated design, the surge power of load too high

8. TECHNICAL SPECIFICATIONS

Model	Keeper1220	Keeper1230	Keeper1240
Rated charge current	20A	30A	40A
System rated voltage	12V/24V Auto work		
Voltage range of battery	8-32V		
Max open voltage of PV module	75V		100V
Battery type	User default, Sealed, Flooded, GEL, LiFePO4		
Equalized charging voltage	Maintenance-free lead acid battery 14.6V, GEL: No; Lead acid flooded battery: 14.8V		
Absorption charging voltage	Maintenance-free lead acid battery 14.4V, GEL: 14.2; Lead acid flooded battery: 14.6V		
Floating charging voltage	Maintenance-free lead acid battery, GEL, Lead acid flooded battery: 13.8V		
Low voltage re-connection (LVR)	Maintenance-free lead acid battery, GEL, Lead acid flooded battery: 12.6V		
Low voltage disconnection (LVD)	Maintenance-free lead acid battery, GEL, Lead acid flooded battery: 10.8V		
Static loss	≤9.2mA 12V; ≤11.7mA 24V		
High voltage disconnection (HVD)	16V (24V x 2)		
Duration of absorption charging	2 Hours		
Light control voltage	5V		
Charge loop voltage drop	≤0.29V		
LCD Temperature	-20°C~+70°C		
Operating Temperature	-20°C~+55°C (To run at full rated current continuously)		
Working humidity	≤95% No condensation		
Protection class	IP30		
Dimension (LxWxH) mm	123x178x48	133x195x55	150x220x67
Installation hole size(LxW)mm	108x120∅5	116x140∅5	132x130∅5