



COTSWOLD GARDEN FURNITURE

Assembly Instructions

The Prestbury Garden Sofa.

The sofa comes boxed and ready for assembly.

To assemble the sofa we recommend this is ideally a 2 person job and should take approx 40 minutes.







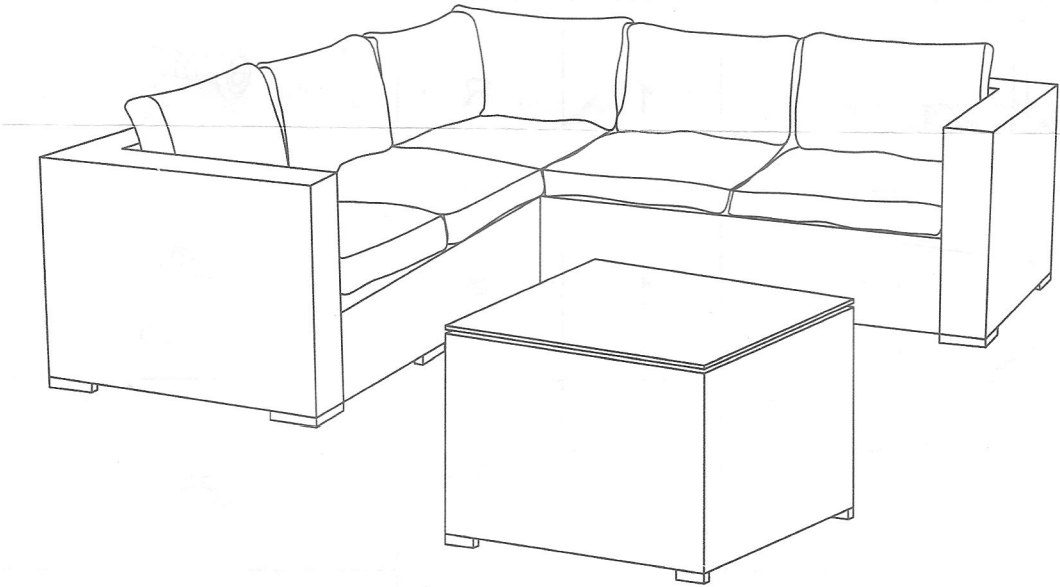

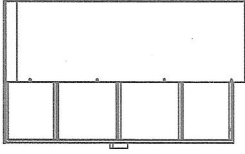
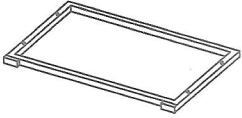
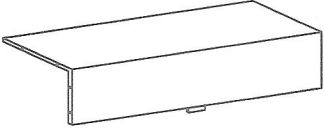

All of the items are coded and we would recommend reading through the instructions carefully prior to starting.

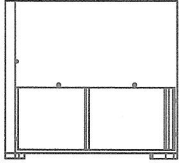
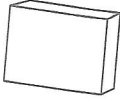
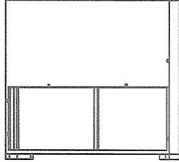
The information above was gathered from our own experience of assembling a sofa.

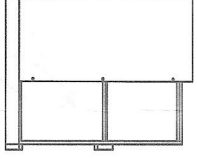

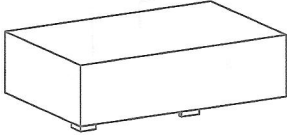

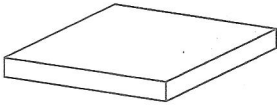
<https://cotswoldgardenfurniture.co.uk>

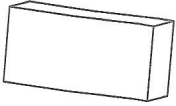
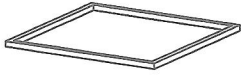
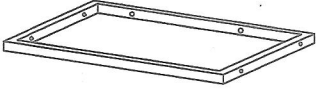

Before Beginning Assembly :

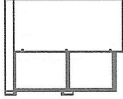
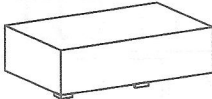
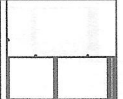
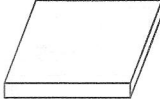

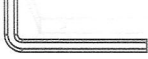
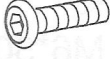
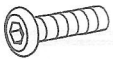
LABEL	PICTURE	QTY	LABEL	PICTURE	QTY
A		1	K		2
B		1	L		1
C		2	M		1
D		1	Q		1
E		1	R		26
F		1	S		13
G		5	T		39
H		5			
I		1			
J		2			

Assembly Instruction_Corner

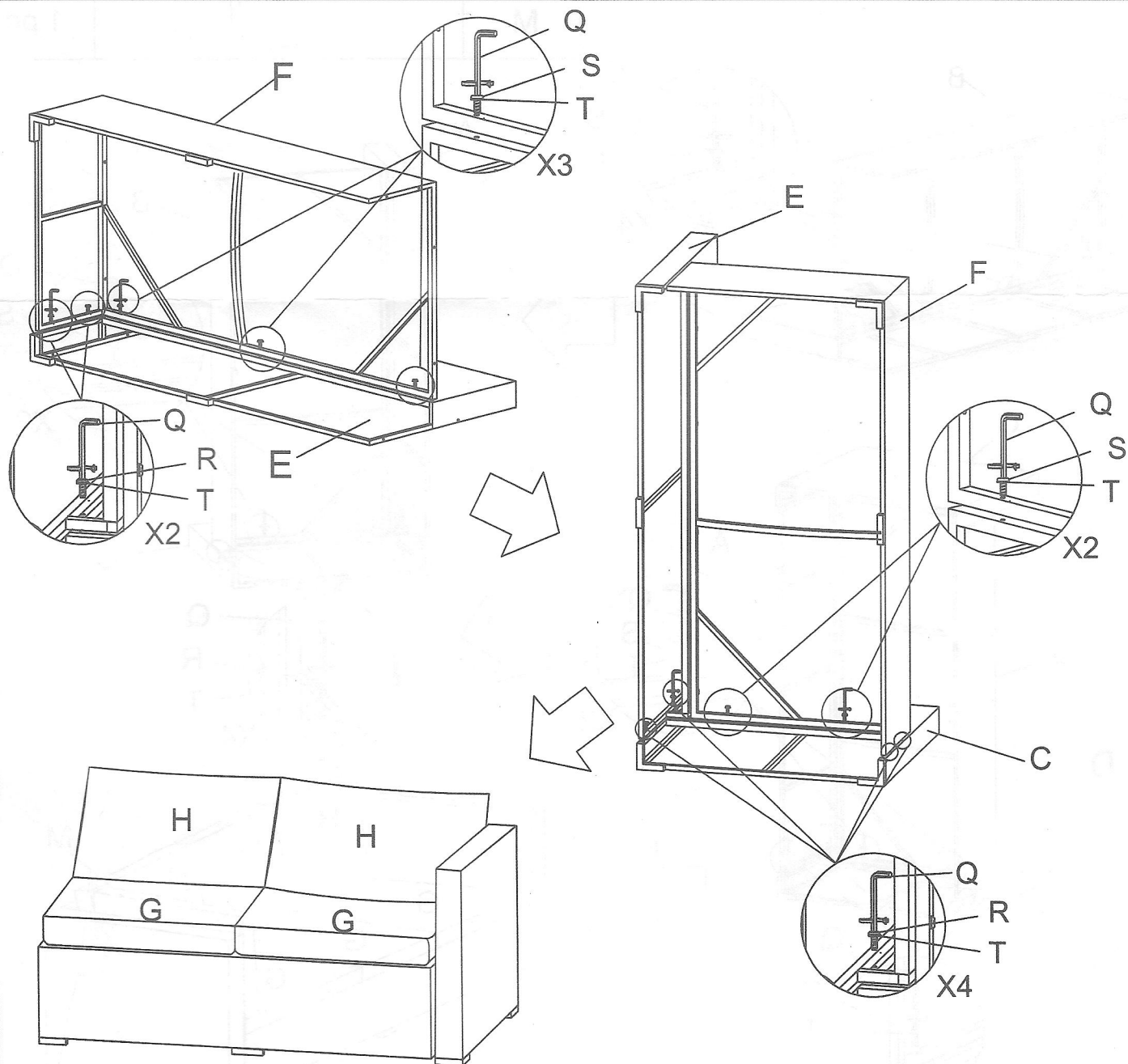
E		1 pc	F		1 pc
C		1 pc	G		2 pcs
H		2 pcs	Q		1 pc
R	 M6*30	6 pcs	S	 M6*35	5 pcs
T		11 pcs			

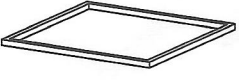
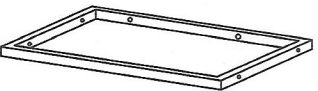
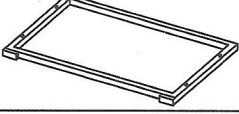
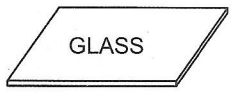

Assembly Instruction_Table

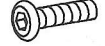
I		1 pc	J		2 pcs
K		2 pcs	L		1 pc
Q		1 pc	R	 M6*30	12 pcs

T		12 pcs
---	---	--------

