





















---

# Vertical & Horizontal Stand

---

Installation

# Instructions

<b>Accessories lists</b>										
 Base 1pc		 Lower Round Tubes +Round Telescoping Tube 1pc		 Safety Pressure Piece 2pcs	 Vertical Hook					
 Rectangular Baffle Plate 1pc		 Long Straight Bracket 2pcs			 Universal Wheel 4pcs	 Plastic Cover 1pc	 L-Shaped Bar 2pcs (For Horizontal Installation)	 Short Straight Bracket 4pcs (For Vertical Installation)		
 Locking Piece 2pcs		 U-Shaped Fixing Block 1pc	 M8 Nut 8pcs (For Vertical Installation)		 Pm5x12 Screws 2pcs		 M6x15mm Inner Hexagonal Screw 4pcs	 M8x25mm Inner Hexagonal Screw 14pcs	 M8x40mm Inner Hexagonal Screw 24pcs	 M8x55mm Inner Hexagonal Screw 16pcs

## **Step 1: Install The Universal Wheel**

- a) Press The Anti-Rotation Lock Of The Universal Wheel.

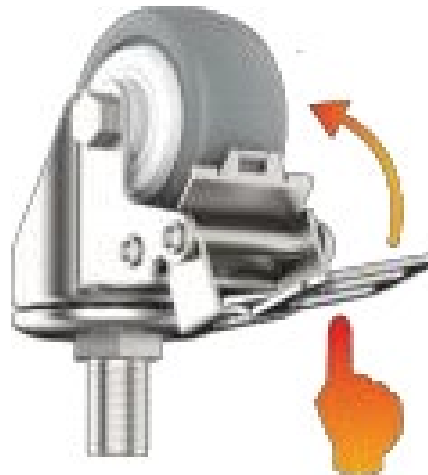

# Instructions

b) Install The 4 Wheels On The Base.



c) Turn Over The Base To Normal.



## **Step 2: Install The Lower Round Tubes**

a) Insert The Lower Round Tube Into The Base Hole.

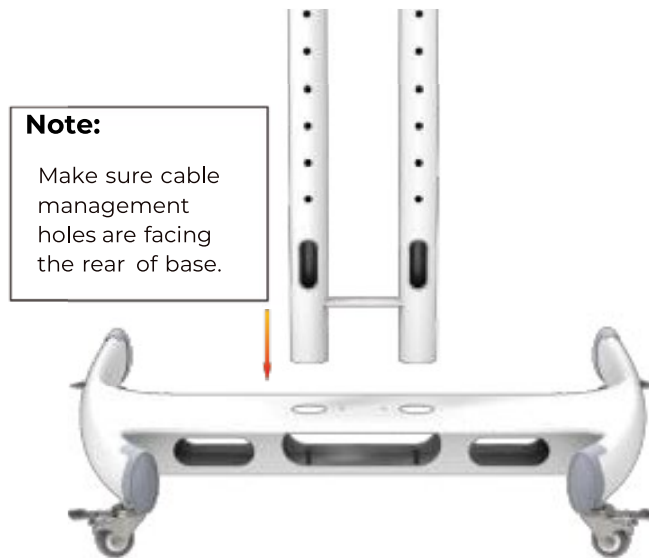

b) Then Lock The M8\*25mm Inner Hexagonal Screws On The Bottom And Middle Of The Round Tube.



# Instructions

## **Step 3: Install The Plastic Cover**

- a) Buckle The Special- Shaped Plastic Cover On The Middle Of The Round Tube.



# Instructions

## **Step 4: Install The Plastic Cover**

- a) First press the positioning pin on the telescopic tube into the lower round tube, adjust the height.

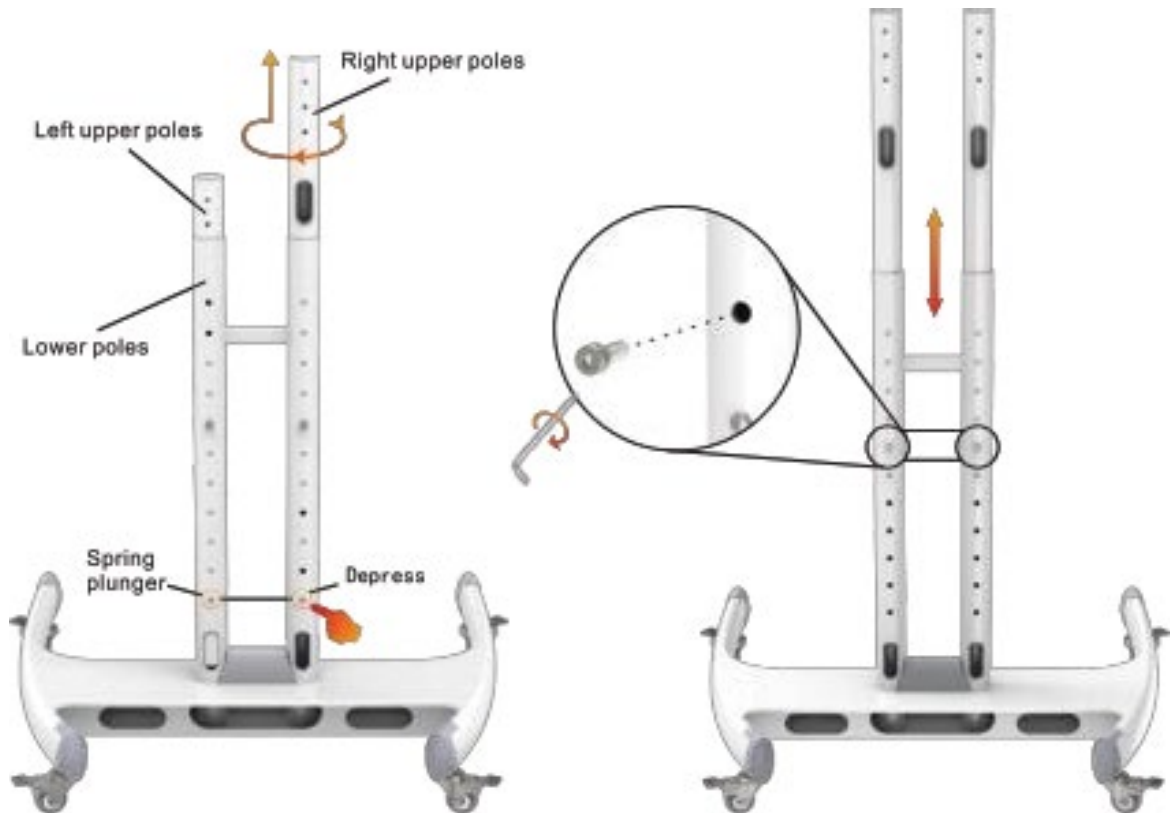

- b) And then lock it with M8\* 25mm hexigon socket screws

## **Step 5: Install The Rectangular Baffle**

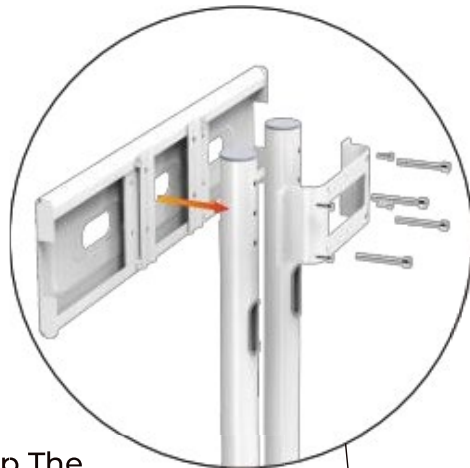

A). Overlap The Rectangular Baffle Plate, The Top Holes Of The Two Round Telescopic Tubes, And The U-Shaped Fixing Block And Align The Holes.

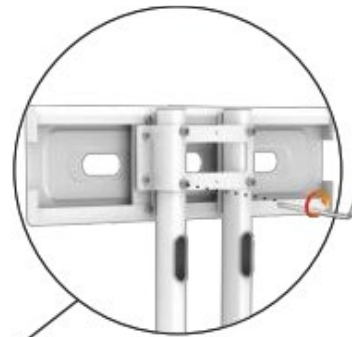

B). Then Lock With The M8\*55mm Inner Hexagonal Screws, And Then Lock The M6\*15mm Inner Hexagonal Screws.





# Instructions

## 4.6A Horizontal Stand Installation:

### **Step 6A:** Install The Long Straight Brackets

- a) Use M8\*40mm Hexagon Socket Screws To Lock The Two Long Straight Brackets On The Back Of The 2 Red Panels.

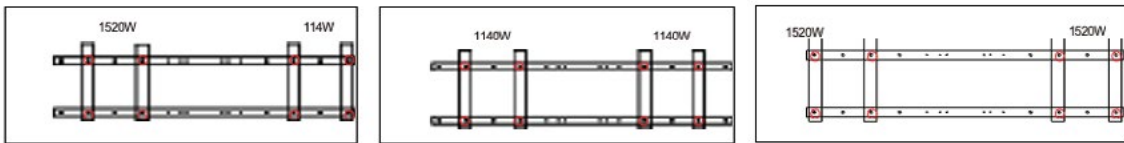
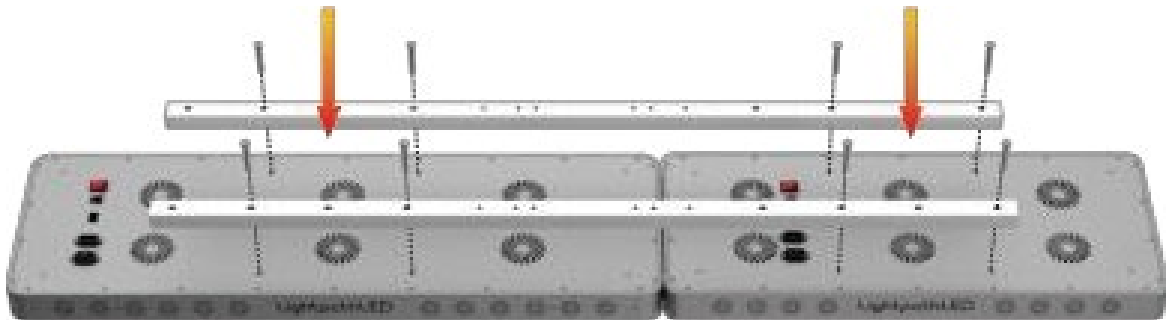

### **Step 7A:** Install The L-Shaped Bars

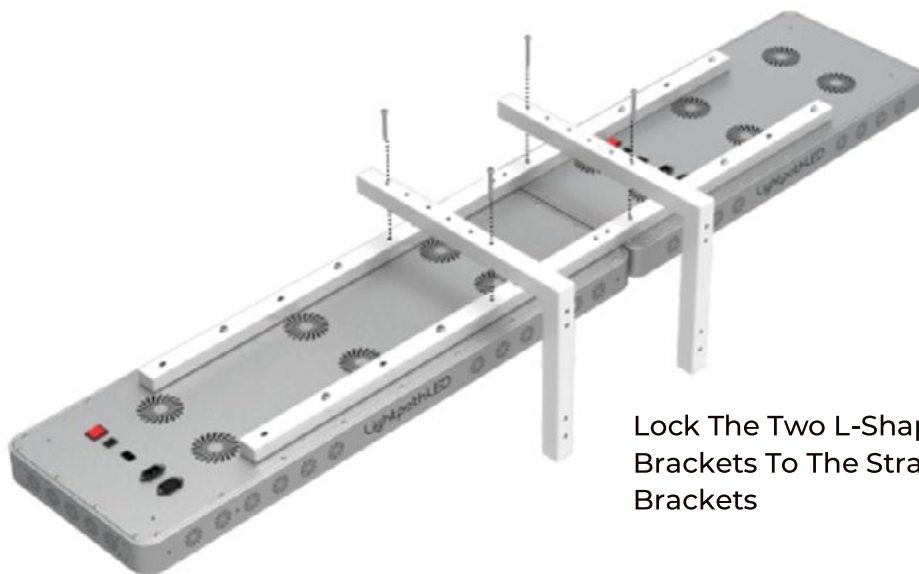

Lock The Two L-Shaped  
Brackets To The Straight  
Brackets

# Instructions

## **Step 8A: Install Vertical Hooks**

a) Padlock The Vertical Hook To The L-Bracket.

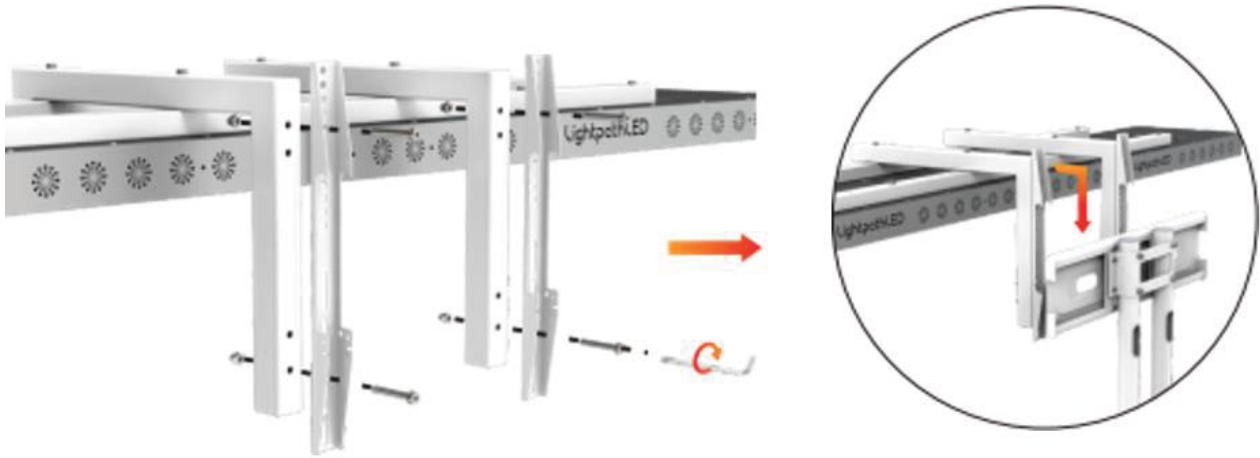

## **Step 9A: Install The Panel Lights On The Stand**

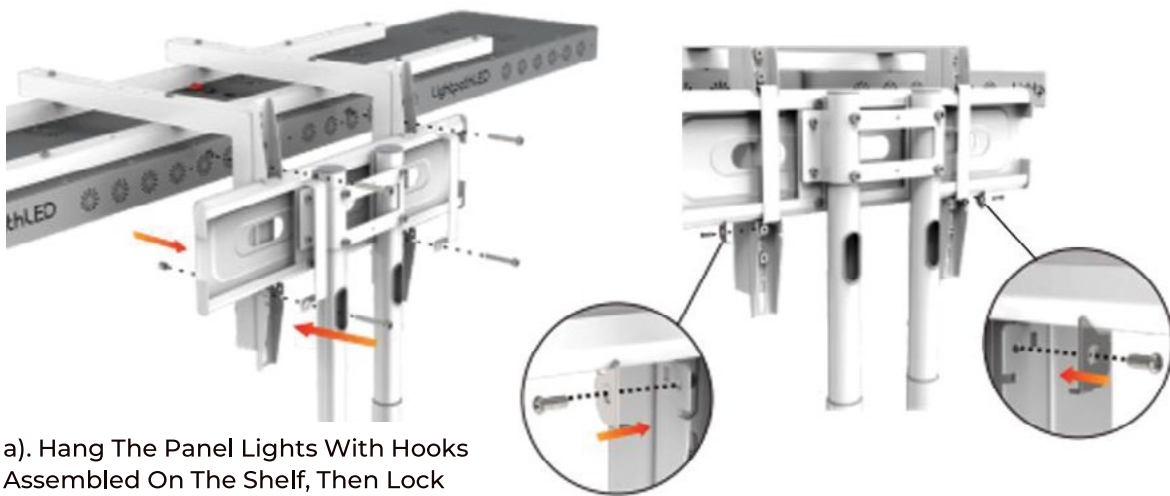

a). Hang The Panel Lights With Hooks Assembled On The Shelf, Then Lock The Left And Right Locking Pieces.

b). And Install The Safety Pressing Piece.

## 4.6B Vertical Stand Installation:

### **Step 6B: Install The Vertical Hook**

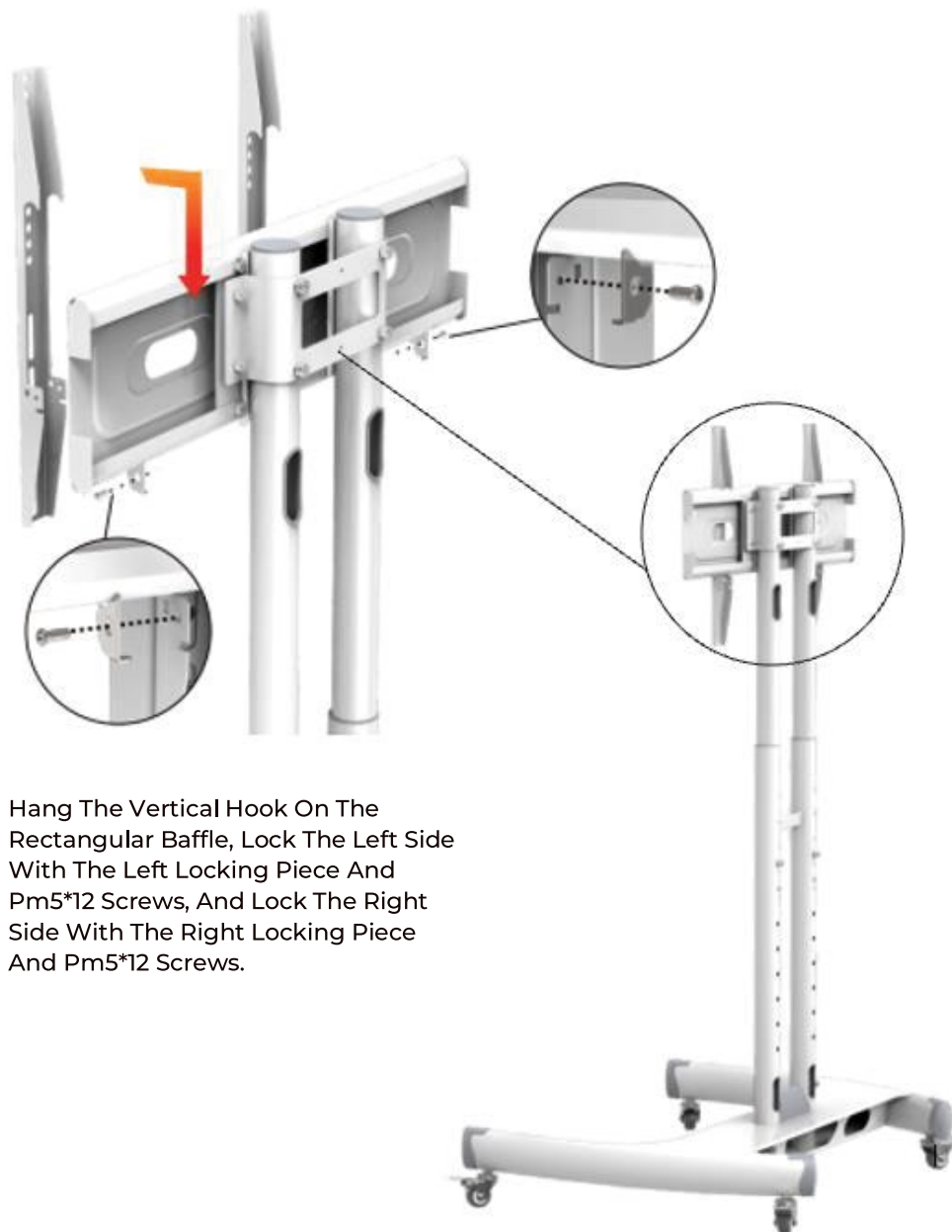

Hang The Vertical Hook On The Rectangular Baffle, Lock The Left Side With The Left Locking Piece And Pm5\*12 Screws, And Lock The Right Side With The Right Locking Piece And Pm5\*12 Screws.

# Instructions

## **Step 7B:** Install The Long Straight Brackets

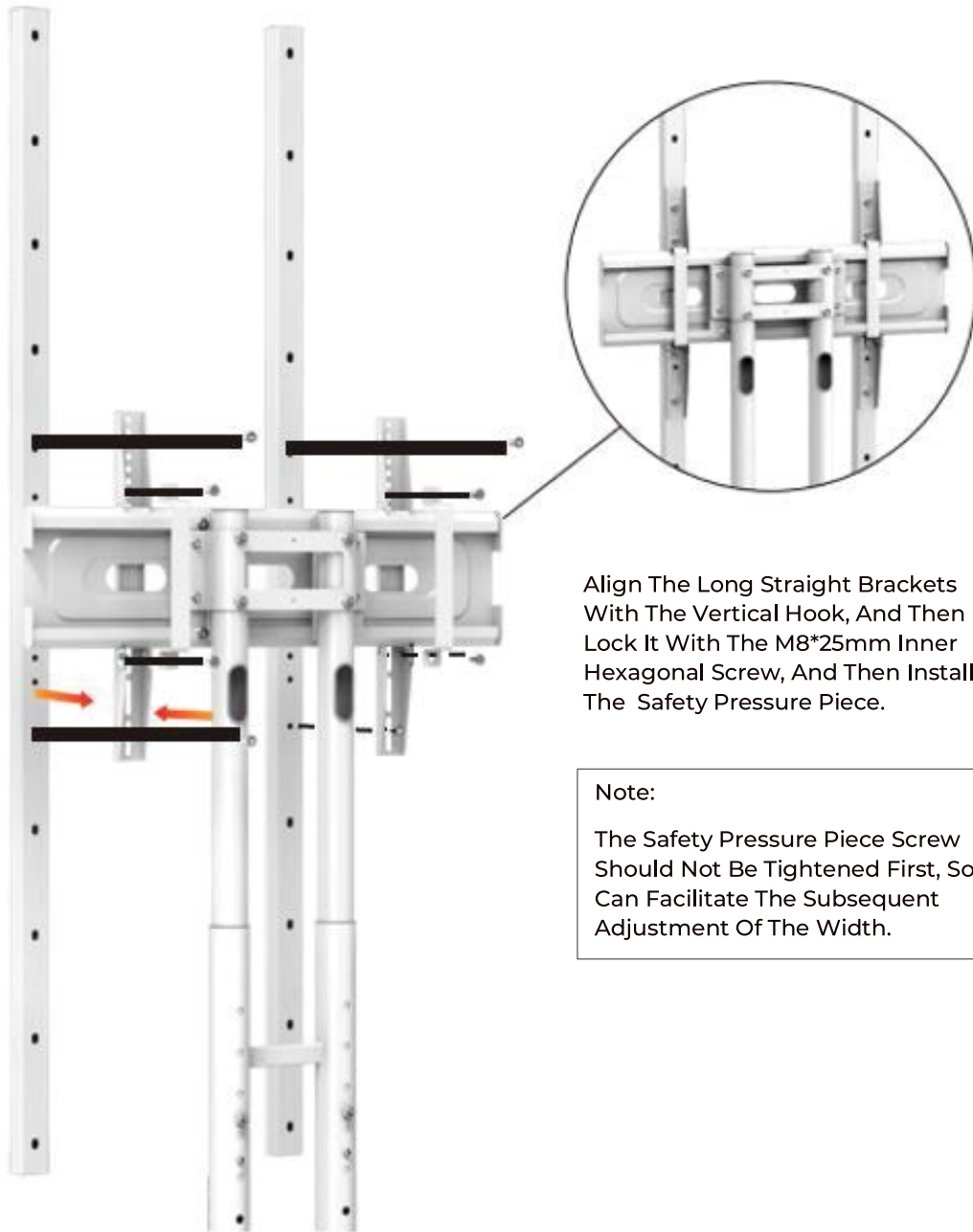

Align The Long Straight Brackets With The Vertical Hook, And Then Lock It With The M8\*25mm Inner Hexagonal Screw, And Then Install The Safety Pressure Piece.

**Note:**

The Safety Pressure Piece Screw Should Not Be Tightened First, So It Can Facilitate The Subsequent Adjustment Of The Width.

# Instructions

## **Step 8B: Install The Short Straight Brackets**

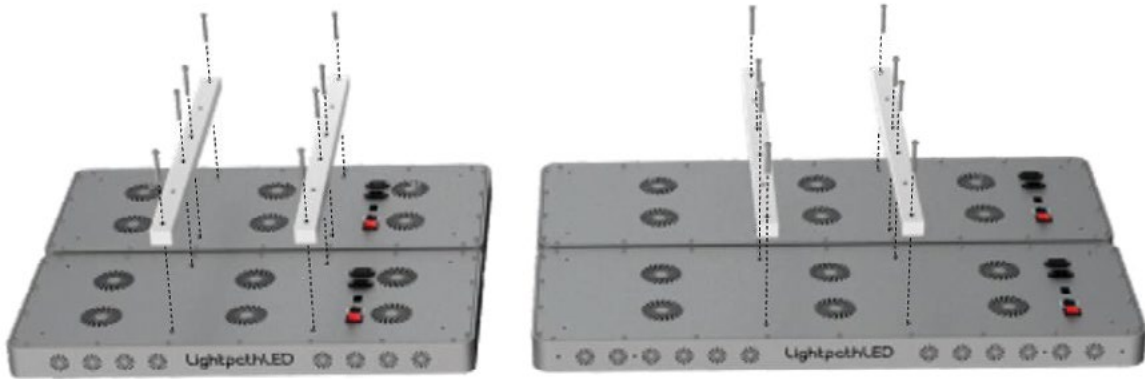

Two Panel Lights Are Arranged Side  
By Side In One Group (2 Groups)



And The Two Short Straight Brackets Are  
Locked On The Back Of The Panel Lights  
With M8\*40mm Inner Hexagonal Screws.

## **Step 9B Install Panel Lights**

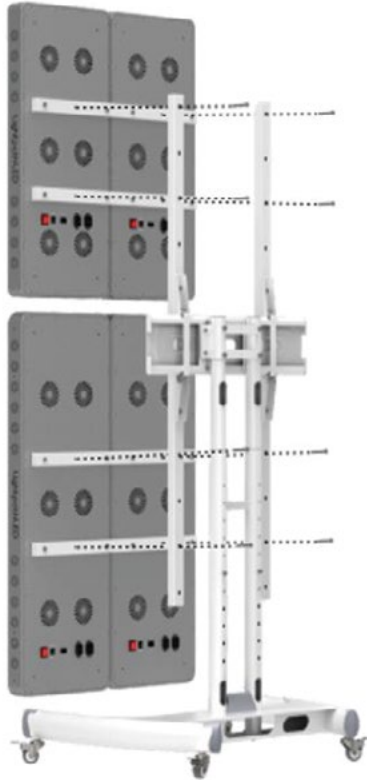

a). Put Two Groups Of Panel Lights Up And Down.



b). And Lock Them on The Vertical Rod With M8\*40mm Hexagon Screws.

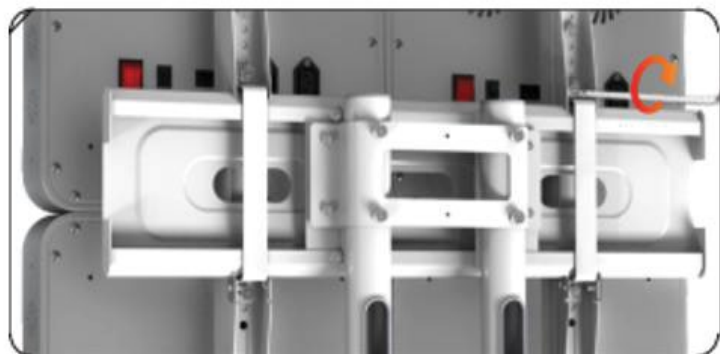

c). Tighten The Safety Screw On The Long Straight Brackets.

# Instructions

## Step 10:

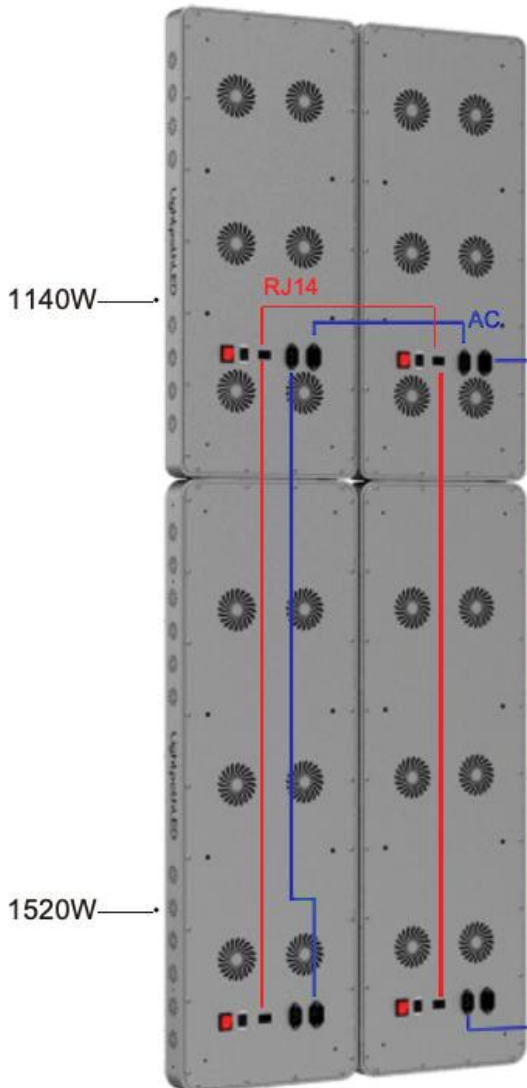
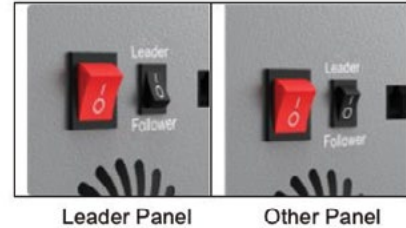

1. Press The "Leader" Key For The Leader Panel(1520W), Press The "Follower" Key For The Other Panel(1140W).
2. Insert The Daisy Chain Cable: Firstly Insert One End Of Daisy Chain Cable Into The Ac Output Port Of The Master(1520W) , And The Other End Into The Ac Input Port Of The Follower(1140W)
3. Insert The Rj 14 Cable To The Leader/Follower Port To Connect The 2 Panels.

**Note:**

Any Panel Can Be The Leader Panel.