

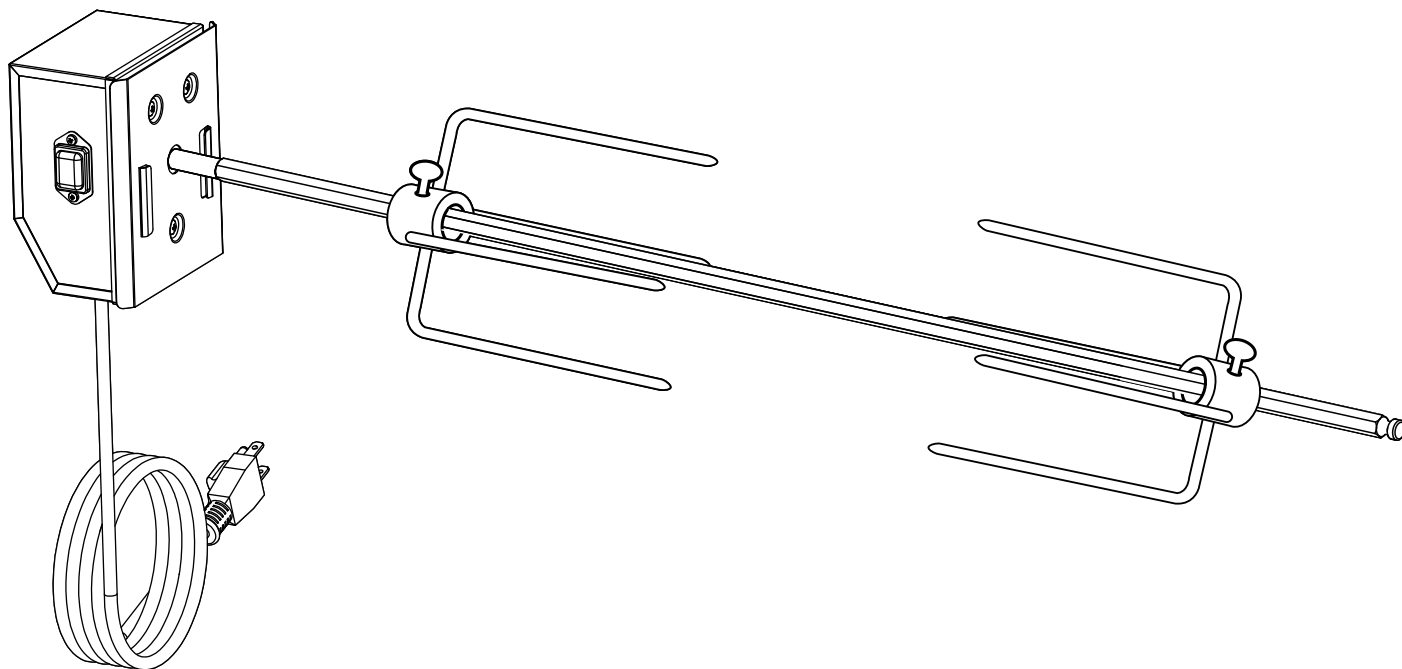

Rotisserie Set up Manual

For Liquid Propane and Natural Gas Grill



Available in
30" - 36" - 42"

FOR OUTDOOR USE ONLY

HOW TO INSTALL A ROTISSERIE

The following tools are required to assemble this Wildfire Rotisserie:

- Phillips Screw Driver
- 10mm Wrench

1 Unbox. Make sure all parts are included before installation. If any parts are missing call customer service at 602-344-4840 or email at customerservice@wildfireoutdoorliving.com.

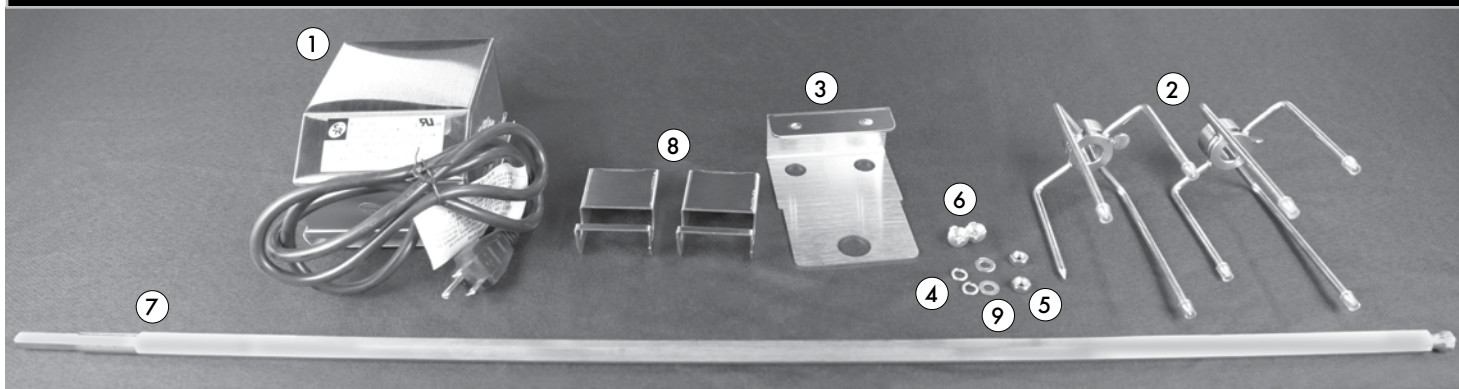

- | | | | |
|------------------------------------|--------------|--------------------------------|-------------------------------|
| ① (1) Rotisserie Motor (25lbs Max) | ② (2) Forks | ③ (1) Rotisserie Motor Bracket | ④ (2) Washers |
| ⑤ (2) Nuts | ⑥ (2) Screws | ⑦ (1) Skewer | ⑧ (2) Skewer Storage Brackets |
| ⑨ (2) Lock Washers | | | |

2 Bracket screw holes. (These are intentionally angled)

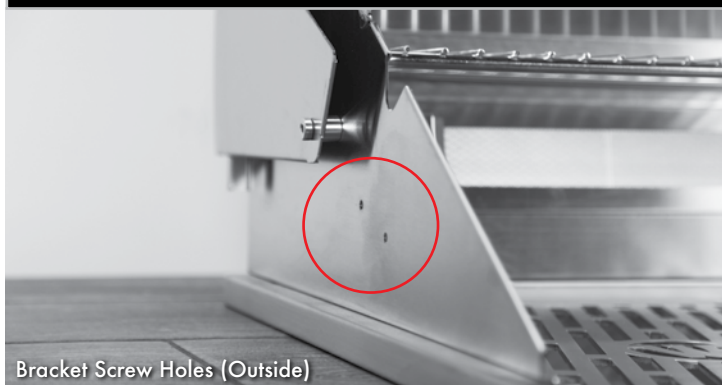

3 Align the bracket to the holes on the left side of grill.

*Note: This is the only side to mount bracket.



4 Put a flat washer onto the inside of the small screw.

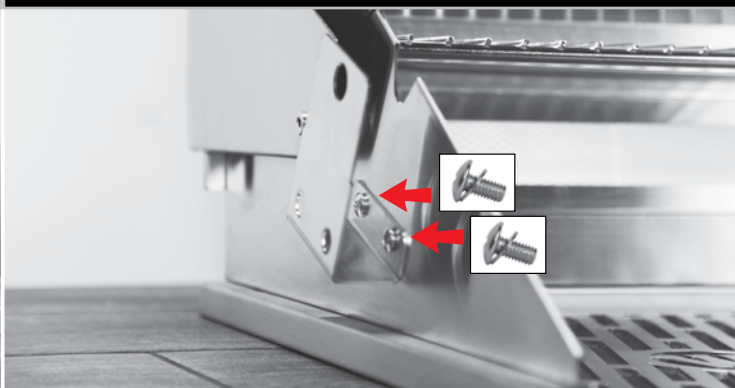

HOW TO INSTALL A ROTISSERIE

5 Using your phillips screwdriver push the screw with the washer on it through the aligned holes.

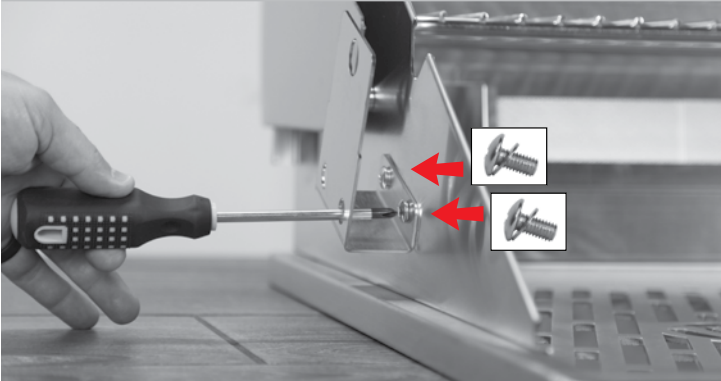

6 Slide lock washer onto screw from the inside of the grill. Place nut onto screw tighten with your finger. Repeat this step for the other screw.



7 Using your 10mm wrench and phillips screwdriver hold screw and tighten the nut.

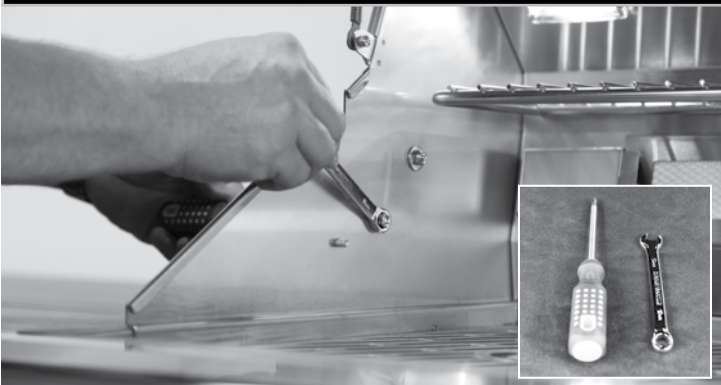

8 Place your rotisserie motor on the bracket.
**Note: Our rotisseries can hold a maximum of 25lbs.*



9 Place your forks on the skewer. Adjust skewers to size and **tighten wing nuts**.
**Note: Our rotisseries can hold a maximum of 25lbs.*

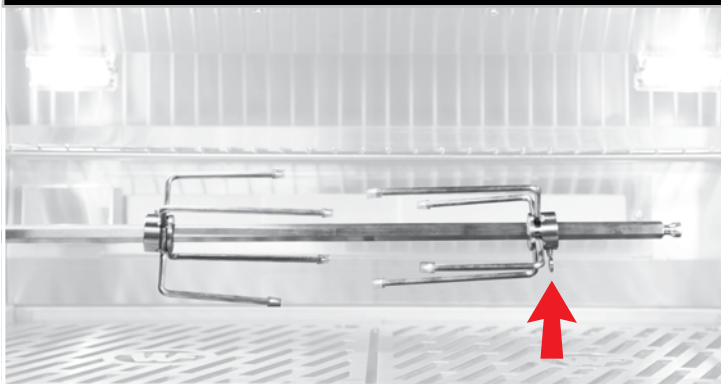

10 Slide your skewer into the motor.
**Note: Do not force it. Rotate your skewer until it slides in with ease.*



HOW TO INSTALL A ROTISSERIE

11

The other end will rest on the notch in the grill.

*Note: Do not force it. Rotate your skewer until it slides in with ease.



12

Plug in your rotisserie motor into the outlet.

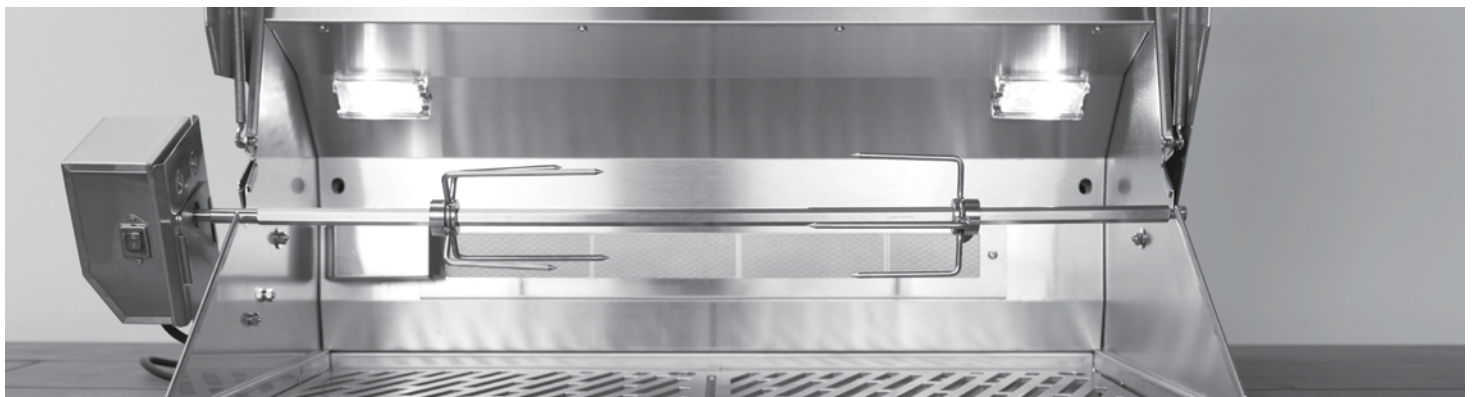
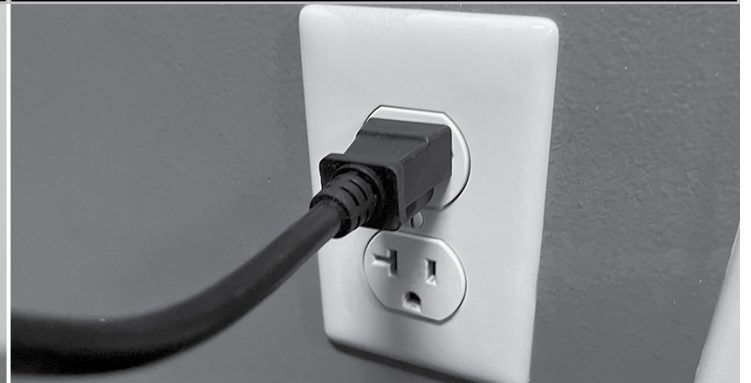

INSTALLATION COMPLETE

READY TO ENJOY!

DO NOT RETURN TO STORE!



CALL US FIRST

For immediate help with installation, product information or if your product arrives damaged, please call our toll free number at:

602-344-4840

(Monday - Friday, 8:00AM - 5:00PM, AZ Mountain Time)

Or email us at

customerservice@wildfireoutdoorliving.com

OUR STAFF IS READY TO PROVIDE ASSISTANCE

RPG BRANDS

MODERN
ELECTRIC FLAMES
REPLACES

WILDFIRE

GRAND
CANYON
LOGS