

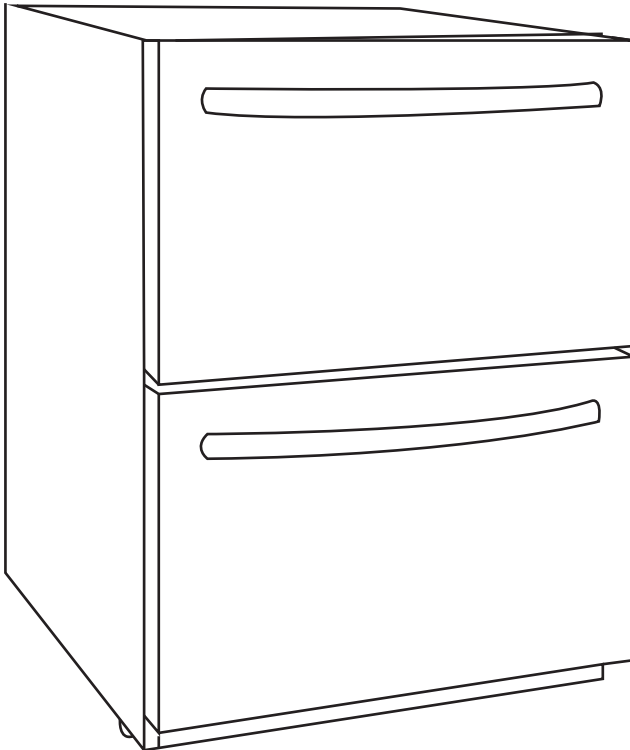

**Renaissance**  
Cooking Systems

## **OUTDOOR TWO DRAWER STAINLESS STEEL REFRIGERATOR**



### **INSTRUCTION MANUAL**

BEFORE USE PLEASE READ AND FOLLOW ALL SAFETY RULES AND OPERATING INSTRUCTIONS.

**RCSGasGrills.com**

# TABLE OF CONTENTS

|   |              |
|---|--------------|
| <b>Appliance Safety</b>                 | <b>3</b>     |
| <b>Important Safeguards</b>             | <b>3-4</b>   |
| <b>Installation Instructions</b>        | <b>5-7</b>   |
| Before Using Your Appliance             | 5            |
| Installation of Your Appliance          | 5-6          |
| Site Preparation                        | 6            |
| Anti-tip Bracket Installation           | 6            |
| Leveling the Unit                       | 7            |
| Installing Handle                       | 7            |
| Electrical Connection                   | 7            |
| Extension Cord                          | 7            |
| <b>Operation Your Appliance</b>         | <b>8-9</b>   |
| Control Panel                           | 8-9          |
| Defrosting                              | 9            |
| Temperature Alarm / Drawer Alarm        | 9            |
| Removing your Appliance                 | 9            |
| <b>Care and Maintenance</b>             | <b>9-10</b>  |
| Cleaning and Maintaining Your Appliance | 9            |
| Power Failure                           | 10           |
| Vacation Time                           | 10           |
| Moving Your Appliance                   | 10           |
| Energy Saving Tips                      | 10           |
| <b>Troubleshooting</b>                  | <b>11-12</b> |

# APPLIANCE SAFETY

Your safety and the safety of others are very important.

We have provided many important safety messages in this manual and on your appliance. Always read and obey all safety messages.



This is the Safety Alert Symbol. The symbol alerts you to potential hazards that can kill or injure you and others. All safety messages will follow the Safety Alert Symbol and either the DANGER or WARNING.



DANGER means that failure to heed this safety statement may result in severe personal injury or death.



WARNING means that failure to heed this safety statement may result in extensive product damage, serious personal injury or death.

All safety messages will alert you about the potential hazard, tell you how to reduce the chance of injury and let you know what can happen if the instructions are not followed.

---

## IMPORTANT SAFEGUARDS



Before the appliance is used, it must be properly positioned and installed as described in this manual, so read the manual carefully. To reduce the risk of fire, electrical shock or injury when using the appliance, follow basic precautions, including the following:



Plug into a grounded 3 prong outlet, do not remove prong, do not use an adapter and do not use an extension cord.

Replace all panels before operating.

It is recommended that a separate circuit serving only your appliance be provided. Use receptacles that cannot be turned off by a switch or pull chain.

Never clean appliance parts with flammable fluids. These fumes can create a fire hazard or explosion.

Do not store or use gasoline or other flammable vapors and liquids in the vicinity of this or any other appliance. The fumes can create a fire hazard or explosion.

Do not connect or disconnect the electric plug when your hands are wet.

Unplug the appliance or disconnect power before cleaning or servicing. Failure to do so can result in electrical shock or death.

Do not attempt to repair or replace any part of your appliance unless it is specifically recommended in this manual. All other servicing should be referred to a qualified technician.



## WARNING



FOLLOWING WARNING CALLS OUTS BELOW ONLY WHEN APPLICABLE TO YOUR MODEL  
Use two or more people to move and install appliance. Failure to do so can result in back or other injury.

To ensure proper ventilation for your appliance, The front of the unit must be completely unobstructed.

Choose a well-ventilated area with temperatures above 50°F (10°C) and below 109.4°F (43°C).

The appliance should not be located next to ovens, grills or other sources of high heat.

The appliance must be installed with all electrical, water and drain connections in accordance with state and local codes. A standard electrical supply (115 V AC only, 60HZ), properly grounded in accordance with the National Electrical Code and local codes and ordinances, is required.

Do not kink or pinch the power supply cord of the appliance.

The size of the fuse (or circuit breaker) should be 1.3 amperes.

It is important that the appliance be leveled in order to work properly. You may need to make several adjustments to level it.

All installations must be in accordance with local plumbing code requirements.

Make certain that the pipes are not pinched, kinked or damaged during installation.

Check for leaks after connection.

Never allow children to operate, play with or crawl inside the appliance.

Do not use solvent-based cleaning agents or abrasives on the interior. These cleaners may damage or discolor the interior.

Use this appliance only for its intended purpose as described in this *Instruction Manual*.

Keep fingers out of the "pinch point" areas. Clearances between the drawer and cabinet are necessarily small. Be careful closing drawer when children are in the area.



## DANGER



### *Risk of child entrapment!*

Child entrapment and suffocation are not problems of the past. Junked or abandoned appliances are still dangerous, even if they will "just sit for a few days".

*Before discarding your old refrigerator:*

*Take out the drawers.*

**– SAVE THESE INSTRUCTIONS –**

# INSTALLATION INSTRUCTIONS

## **BEFORE USING YOUR APPLIANCE**

Remove the exterior and interior packing.

Before connecting the appliance to the power source, let it stand upright for approximately 24 hours. This will reduce the possibility of a malfunction in the cooling system from handling during transportation.

Clean the interior surface with lukewarm water using a soft cloth.

Install the handle on the drawer, if it not already attached (See page 7).

## **INSTALLATION OF YOUR APPLIANCE**

Your outdoor two drawer refrigerator has been designed for both built-in and free standing. When built-in, your refrigerator drawers do not require additional air space for top, side or rear. The front grille must NOT be obstructed.

**Note:** It is recommended that you do not install the appliance near an oven, radiator or other heating source, as heat sources may increase electrical consumption. Do not install in a location where the temperature will fall below 50°F (10°C). For best performance, do not install the appliance behind a cabinet door or block the base grille.

Avoid locating the unit in moist areas.

Plug the appliance into an exclusive, properly grounded wall outlet.

## **SITE PREPARATION**

1. Position the unit on a flat, level surface capable of supporting the entire weight of the unit.

Remember the unit will be significantly heavier once it is fully loaded.

2. Connect the unit to a Ground Fault Interrupter (GFI).

3. The unit must be installed according to your local codes and ordinances.

4. **ELECTROCUTION HAZARD!**

Electrical Grounding Required- This appliance is equipped with a three prong (grounding) polarized plug for your protection against possible shock hazards.

NEVER remove the round grounding prong from the plug.

NEVER use a two-prong grounding adapter.

NEVER use an extension cord to connect power to the unit.

Where a two-prong wall receptacle is encountered or a longer power cord is required, contact a qualified electrician to have it replaced in accordance with applicable electrical codes.



5. Position the unit to allow free air flow through the front grille.

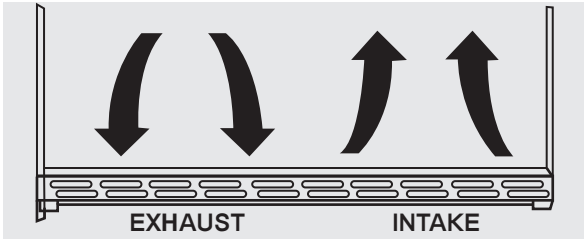

6. Wipe out inside of unit with a damp cloth.

7. Be sure to install the Anti-Tip bracket. Flow instructions provided with the Anti-Tip bracket.



The Anti-tip Bracket must be installed on this unit before it is used. Double stacking units may cause serious personal injury.

### ANTI-TIP BRACKET INSTALLATION

To reduce the risk of tipping the unit by abnormal usage or improper loading, the appliance must be secured by properly installing the anti-tip device packed with the appliance.

- Place the anti-tip bracket on the floor as shown in the figure. An anti-tip bracket can be installed on either right or left side.
- Mark the locations of the 4 holes of the anti-tip bracket on the floor.
- Use a 5/16 masonry drill bit and insert plastic anchors.
- Secure bracket to floor using screws.
- Slide appliance into position and make sure the leg engages the anti-tip bracket.

**NOTE:** If the unit is relocated, the bracket must be removed and installed in the new location.

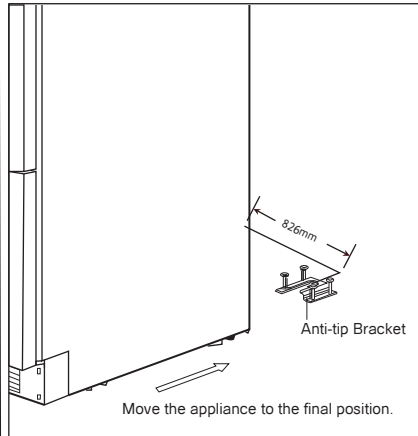
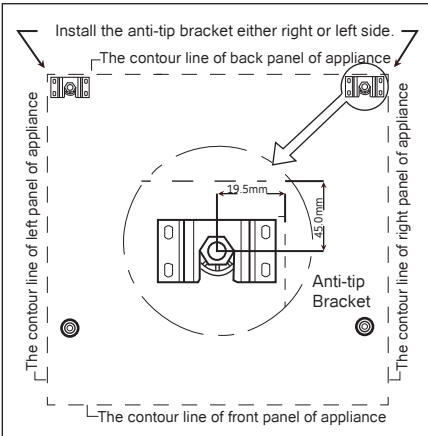

## LEVELING THE UNIT

Position the unit on a flat, level surface capable of supporting the entire weight of the unit when full. This unit contains four (4) adjustable leveling legs. Turn the legs clockwise to raise and counterclockwise to lower.

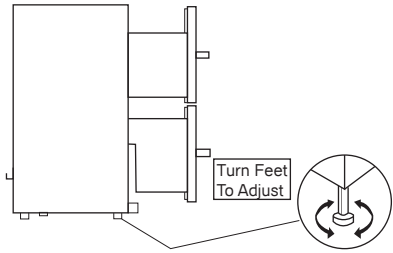
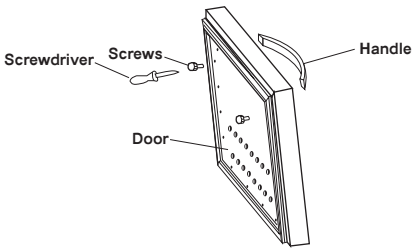

## INSTALLING HANDLE

Put the screws on the top of the drawer where the handle is to be installed. Align the handle with screws, tighten the screws using the screwdrivers.

## ELECTRICAL CONNECTION



### **WARNING**

Improper use of the grounded plug can result in the risk of electrical shock. If the power cord is damaged, have it replaced by a qualified electrician or an authorized service center.

This appliance should be properly grounded for your safety. The power cord of this appliance is equipped with a three-prong plug which mates with standard three-prong wall outlets to minimize the possibility of electrical shock.

Do not under any circumstances cut or remove the third (ground) prong from the power cord supplied. For personal safety, this appliance must be properly grounded. Any questions concerning power and/or grounding should be directed toward a certified electrician or an authorized service center.

This appliance requires a standard 115/120 Volt AC~60Hz three-prong grounded electrical outlet. Have the wall outlet and circuit checked by a qualified electrician to make sure the outlet is properly grounded. When a standard 2-prong wall outlet is encountered, it is your responsibility and obligation to have it replaced with a properly grounded 3-prong wall outlet.

To prevent accidental injury, the cord should be secured behind the appliance and not left exposed or dangling.

The appliance should always be plugged into its own individual electrical outlet which has a voltage rating that matches the rating label on the appliance. This provides the best performance and also prevents overloading house wiring circuits that could cause a fire hazard from over heating. Never unplug the appliance by pulling on the power cord. Always grip the plug firmly and pull straight out from the receptacle. Repair or replace immediately all power cords that have become frayed or otherwise damaged. Do not use a cord that shows cracks or abrasion damage along its length or at either end. When moving the appliance, be careful not to damage the power cord.

## EXTENSION CORD

Because of potential safety hazards under certain conditions, it is strongly recommended that you do not use an extension cord with this appliance. However, if you must use an extension cord it is absolutely necessary that it be a UL/CUL-Listed, 3-wire grounding type appliance extension cord having a grounding type plug and outlet and that the electrical rating of the cord be 115 volts and at least 1.3 amperes.

# OPERATING YOUR APPLIANCE

It is recommended that you install the appliance in a place where the ambient temperature is between 50°F and 109.4°F (10°C-43°C). If the ambient temperature is above or below recommended temperatures, the performance of the unit may be affected. For example, placing your unit in extremely cold or hot conditions may cause interior temperatures to fluctuate. The operating temperature range may not be reached.

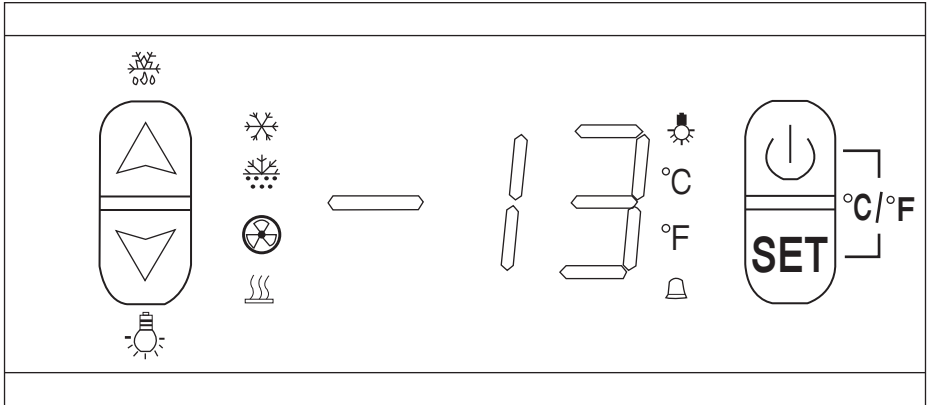

## CONTROL PANEL



### ON/OFF Power



To turn the appliance ON or OFF, press and hold the POWER key  for 5 seconds.

### UP and DOWN



Press  first, then press  or  button to increase (warm) or decrease (cool) the set temperature by 1°C/1°F.

Press  again, the temperature is selected and shows the actual temperature. If no other further operation in 6 seconds, display will show actual temperature in the cooler.

### °C/°F Selector

Selects the temperature display setting in Fahrenheit or Celsius degrees. To change the temperature from Fahrenheit to Celsius or from Celsius to Fahrenheit, press  and  at the same time, then hold for 6 seconds.

### Setting the Temperature Control

The temperature you are setting will increase by one degree each time you press the  key, and will decrease by one degree each time you press the  key.

The range of the temperature control is from 23°F to 68°F.

To view the set temperature at any time, press the  key. The set temperature will flash in the display window for 6 seconds. After 6 seconds, the temperature inside the unit will reappear in the display window.

(The temperature preset at the factory is 39°F).



### **Interior Light**

The unit is equipped with an interior LED light which will be turned ON when the drawer is open and the interior fan is stopped at the same time.

You can press ▽ manually to turn on or turn off the light.

### **Defrosting**

The unit defrosts automatically in normal operating conditions.

The evaporator behind the rear wall of the unit defrosts automatically. The condensate collects in the drainage channel behind the rear wall of the unit and flows through the drainage hole into the drip tray by the compressor where it evaporates.

However, frost may accumulate on the evaporator if the unit is repeatedly opened in a high heat or high humidity location. If this frost pattern does not clear within 24 hours, your unit will require manual defrosting.

Press △ and hold for 6 seconds, the unit will be defrosted.

To stop defrost, please repeat the same interaction.

### **TEMPERATURE ALARM**

An audible alarm sounds if the storage temperature is not cold enough. The temperature display flashes at the same time.

The cause of the temperature being too high may be:

- Warm fresh food was placed inside
- Too much warm ambient air flowed in when rearranging and removing stored items
- Power failure for some time
- The appliance is faulty

The audible alarm is automatically silenced and the temperature display stops flashing when the temperature is sufficiently cold again.

## **CARE AND MAINTENANCE**

### **CLEANING AND MAINTAINING YOUR APPLIANCE**

Periodic cleaning and proper maintenance will ensure efficiency, top performance and long life. The maintenance intervals listed are based on normal conditions. You may want to shorten the intervals if you have pets or other special considerations.

Exterior Cleaning for Your Stainless Steel Model

- Your stainless steel model may discolor when exposed to chlorine gas, pool chemicals, salt water or cleaners with bleach.
- Keep your stainless unit looking new by cleaning with a high quality, all-in-one stainless steel cleaner/polish on a monthly basis. Frequent cleaning will remove surface contamination that could lead to rust. Some installations will require cleaning on a weekly basis.
- DO NOT CLEAN WITH STEEL WOOL PADS.
- DO NOT USE CLEANERS THAT ARE NOT SPECIFICALLY INTENDED FOR STAINLESS STEEL (this includes glass, tile and counter cleaners).
- If any surface discolors or rusting appears, clean it quickly with Bon-Ami or Barkeepers Friend Cleanser and a non-abrasive cloth. Always clean in the direction of the grain. Always finish this process with a high quality, all-in-one stainless steel cleaner/polish to prevent further problems.
- USE OF ABRASIVE PADS SUCH AS SCOTCHBRITE WILL CAUSE THE GRAINING IN THE STAINLESS TO BECOME BLURRED.
- Rust that is allowed to linger can penetrate into the surface of the stainless steel and become impossible to remove.



## CAUTION



- Stainless steel models exposed to chlorine gas and moisture such as areas with spas or swimming pools, may have some discolorations of the stainless steel. Discoloration from chlorine gas is normal. Follow exterior cleaning instructions.
- NEVER USE CHLORIDE TO CLEAN STAINLESS STEEL.

### **POWER FAILURE**

Most power failures are corrected within a few hours and should not affect temperature of your appliance if you minimize the number of times the drawer is opened. If the power is going to be off for a longer period of time, you need to take the proper steps to protect the contents.

### **VACATION TIME**

**Short vacations:** Leave the appliance operating during vacations of less than three weeks.

**Long vacations:** If the appliance will not be used for several months, remove all items and turn off the appliance. Clean and dry the interior thoroughly. To prevent odor and mold growth, leave the drawer open slightly, blocking it open if necessary.

### **MOVING YOUR APPLIANCE**

1. Remove all items.
2. Securely tape down all loose items inside your appliance.
3. Turn the adjustable legs up to the base to avoid damage.
4. Tape the drawer shut.
5. Be sure the appliance stays secure in the upright position during transportation. Also protect the outside of the appliance with a blanket or similar item.

### **ENERGY SAVING TIPS**

The appliance should be located in the coolest area of the room or outdoor location, away from heat producing appliances and out of direct sunlight.

Ensure that the unit is adequately ventilated. Never cover air vents.

Do not keep the drawer open any longer than necessary.

Let hot foods cool to room temperature before placing in the unit. Overloading the unit forces the compressor to run longer.

Be sure to wrap foods properly and wipe containers dry placing them in the unit. This cuts down on frost build up inside the unit.

Unit drawers should not be lined with aluminum foil, wax paper or paper toweling.

Liners interfere with cold air circulation, making the unit less efficient.

Organize and label stored items reduce drawer openings and extended searches. Remove as many items as needed at one time and close the drawer as soon as possible.

# TROUBLESHOOTING

You can solve many common problems easily, saving you the cost of a possible service call. Try the suggestions below to see if you can solve the problem before calling the servicer.

| PROBLEM                                       | POSSIBLE CAUSE  | REMEDY  |
|---|---|---|
| Appliance does not operate.                   | Appliance is not connected to a power supply.<br>The appliance is turned off.<br>Tripped circuit breaker or blown a fuse.   | Connect the appliance.<br>Switch on the appliance.<br>Switch on circuit breaker or replace fuse.  |
| Appliance is not cold enough.                 | The temperature is not set correctly.<br>Temperature could require a lower temperature setting.<br>The drawer was not closed completely.<br>Drawer is not hermetically sealed.<br>The condenser is too dirty.<br>The ventilation opening is blocked or too dusty.   | Check the set temperature.<br>Set a lower temperature.<br>Do not open the drawer more often than necessary.<br>Close drawer properly.<br>Check the drawer seal and clean/replace.<br>Clean the condenser when necessary.<br>Clear the obstructions, clean the dust. |
| Appliance turns itself on and off frequently. | The room temperature is higher than average.<br>A large amount of food has been added to the unit.<br>The drawer is open too often.<br>The drawer is not closed completely.<br>The drawer gasket does not seal properly.  | Put the appliance in a cooler place.<br>Leave the appliance to work for a while until the set temperature has been reached.<br>Do not open more than necessary.<br>Close drawer properly.<br>Check the drawer seal and clean/replace.                               |
| The light does not work.                      | Appliance is not connected to a power supply.<br>Tripped circuit break or blown a fuse.<br>The light was switched off on the control panel.   | Connect the appliance.<br>Switch on circuit breaker or replace fuse.<br>Switch on the light.  |
| Vibrations                                    | The appliance is not properly leveled.  | Level the appliance with the adjustable feet.   |
| The appliance seems to make too much noise.   | The rattling may come from the flow of the refrigerant, which is normal. As each cycle ends, you may hear gurgling sounds caused by the flow of refrigerant in your appliance. If temperature fluctuations occur, the contraction and expansion of the inner walls may cause popping and cracking noises. |   |
|   | The appliance is not properly level.  | Level the appliance with the adjustable feet.   |
| The drawer will not close properly.           | The appliance is not properly level.<br>The drawer was reversed and not properly installed.<br>The gasket is dirty.   | Level the appliance with the adjustable feet.<br>Check the drawer hinge and reassemble correctly.<br>Clean the drawer gasket.   |

|  |   |  |
|--|---|--|
| <p>The alarm sounds and the temperature display flashes.</p> | <p>Has the appliance drawer been open for longer than 60 seconds? If not, then the temperature has risen higher or fallen lower than the temperature that has been set. This could be due to:<br/>         The appliance drawer being opened too often.<br/>         The ventilation opening being covered or too dusty.<br/>         A lengthy interruption in the power supply.<br/>         A large amount of food has been added to the unit.</p> | <p>If yes, close the drawer.</p> <p>Do not open the drawer more often than necessary.<br/>         Clear the obstructions and clean the dust.<br/>         Leave the appliance to work for a while until the set temperature has been reached.</p> |
| <p>Fridge is not cooling, but the lights are on</p>          | <p>Is the compressor hot?</p> <p>Is the compressor cool?</p>  | <p>If so, the compressor has failed.</p> <p>If so, the compressor relay's failed and need to be replaced</p>   |



# Renaissance Cooking Systems

## Renaissance Cooking Systems Product Warranty

**RCS is proud to provide the industries most comprehensive warranty program.**

All RCS refrigeration and sink products are warranted to be free from manufacturer defects for 5 years to the original owner.

This RCS warranty is effective for product sales beginning January 1st, 2020.

For service assistance, please reach out to us at the email address below. You may also check our website for lots of great information on using, servicing, or cooking on your new RCS grill.

This warranty excludes normal surface corrosion, discoloration, surface scratches and surface rust which may occur. Improper maintenance, salt spray, chemicals, pesticides will affect the look and integrity of the components of this grill. RCS will not be responsible for any damage caused as a result of not following owner's manual instructions. This non-transferrable warranty is limited to the replacement of original (one-time) defective parts, does not include shipping and labor to remove or install replacement parts, if necessary. The owner must retain and submit their original receipt with any warranty claim to receive warranty parts. The warranty applies to the original owner only. Coverage is for residential use only, no commercial applications apply. No registration required.

For more information, questions or assistance please contact us at:  
[RCSTGasGrills.com](http://RCSTGasGrills.com) ~ [CustomerService@RCSTGasGrills.com](mailto:CustomerService@RCSTGasGrills.com)

