

# FORNO SERIES



## El Series

On/Off Models

Installation & Operation  
Instructions



FIRE INSPIRED<sup>®</sup>

Inspired by safety.  
Innovated for your lifestyle.

Hearth Products Controls



**This is a Safety Alert Symbol**



When you see this symbol on the fire pit insert, or in this manual, look for one of the following signal word panels alerting you to the potential for personal injury, death, or major property damage.



**WARNING: For Outdoor Use Only.**

**Installation and service must be performed by a qualified installer, service agency, or the gas supplier.**



**WARNING**

**Do not store or use gasoline or other flammable vapors and liquids in vicinity of this or any other appliance.**

**An LP-cylinder not connected for use shall not be stored in the vicinity of this or any other appliance.**



MINIMUM CLEARANCES TO COMBUSTIBLE AND NON-COMBUSTIBLE CONSTRUCTION.

COMBUSTIBLES: SIDES 2" BACK 2"

NON-COMBUSTIBLES: SIDES 0" BACK 0"

ADEQUATE CLEARANCE MUST BE PROVIDED FOR AIR OPENINGS INTO THE COMBUSTION

CHAMBER, FOR SERVICING AND PROPER OPERATION THE BOTTOM HALF OF THE OVEN SHOULD STAY OPEN. THIS WILL ALLOW FOR PROPER COMBUSTION AIR INTO THE BURNER HOUSING. NOT HAVING PROPER COMBUSTION AIR WILL CAUSE IMPROPER OPERATION AND MAY CAUSE DAMAGE TO THE BURNER SYSTEM.

KEEP APPLIANCE FREE AND CLEAR FROM COMBUSTIBLES.

DO NOT OBSTRUCT THE FLOW OF COMBUSTION AND VENTILATION AIR TO THE APPLIANCE.

ELECTRICAL AND GAS REQUIREMENTS ARE SPECIFIED FOR PROPER INSTALLATION AND USE OF OVEN.

INSTALLATION MUST CONFORM WITH LOCAL CODES, OR IN THE ABSENCE OF LOCAL CODES, WITH THE NATIONAL FUEL GAS CODE ANSI Z223.1, THE NATURAL GAS INSTALLATION CODE CAN/CGA-B149.1 OR THE

PROPANE INSTALLATION CODE CAN/CGA-149.2, AS APPLICABLE, INCLUDING:

1>>THE APPLIANCE AND ITS INDIVIDUAL SHUT OFF VALVE MUST BE DISCONNECTED FROM THE GAS SUPPLY PIPING SYSTEM DURING ANY PRESSURE TESTING OF THAT SYSTEM AT TEST PRESSURES IN EXCESS OF ½ PSI (3.45 Kpa).

2>>THE APPLIANCE MUST BE ISOLATED FROM THE GAS SUPPLY PIPING SYSTEM BY CLOSING ITS INDIVIDUAL MANUAL SHUTOFF VALVE DURING ANY PRESSURE TESTING OF THE GAS SUPPLY PIPING SYSTEM AT THE TEST PRESSURES EQUAL TO OR LESS THAN ½ PSI (3.45 Kpa).

THIS APPLIANCE, WHEN INSTALLED, MUST BE ELECTRICALLY GROUNDED IN ACCORDANCE WITH LOCAL CODES, OR IN THE ABSENCE OF LOCAL CODES, WITH THE NATIONAL ELECTRICAL CODE, ANSI/NFPA 70 OR THE CANADIAN ELECTRICAL CODE, CSA C22.1, AS APPLICABLE.

ELECTRICAL AND GAS REQUIREMENTS:

-1 120VAC – 2.5 AMP OUTLET

- ½ INCH GAS OUTLET

-GAS INLET PRESSURE TO OVEN: 7" W.C. FOR NATURAL, 10" W.C. FOR LP GAS



**⚠ DANGER • FLAMMABLE GAS UNDER PRESSURE.**  
**LEAKING LP-GAS MAY CAUSE A FIRE OR EXPLOSION IF IGNITED**  
**CAUSING SERIOUS BODILY INJURY OR DEATH.**  
**CONTACT LP GAS SUPPLIER FOR REPAIRS, OR DISPOSAL OF THIS**  
**CYLINDER OR UNUSED LP-GAS.**

**⚠ WARNING • FOR OUTDOOR USE ONLY.\***  
**DO NOT USE OR STORE CYLINDER IN A BUILDING,**  
**GARAGE OR ENCLOSED AREA.**

**⚠ WARNING:**

- Know the odor of LP-gas. If you hear, see or smell leaking LP-gas, immediately get everyone away from the cylinder and call the Fire Department. Do not attempt repairs.
- Caution your LP-gas supplier to:
  - Be certain cylinder is purged of trapped air prior to first filling.
  - Be certain not to over fill the cylinder.
  - Be certain cylinder requalification date is checked.
- LP-gas is heavier than air and may settle in low places while dissipating.
- Contact with the liquid contents of cylinder will cause freeze burns to the skin.
- Do not allow children to tamper or play with cylinder.
- When not connected for use, keep cylinder valve turned off. Self contained appliances shall be limited to a cylinder of 30 lb capacity or less.
- Do not use, store or transport cylinder where it would be exposed to high temperatures. Relief valve may open allowing a large amount of flammable gas to escape.
- When transporting, keep cylinder secured in an upright position with cylinder valve turned off.

**WHEN CONNECTING FOR USE:**

- Use only in compliance with applicable codes.
- Read and follow manufacturer's instructions.
- Consult manufacturer's instructions concerning the cylinder connection provided with your appliance.
- Be sure regulator vent is not pointing up.
- Turn off all valves on the appliance.
- Do not check for gas leaks with a match or open flame. Apply soapy water at areas marked "X". Open cylinder valve. If bubble appears, close valve and have LP-gas service person make needed repairs. Also, check appliance valves and connections to make sure they do not leak before lighting appliance.
- Light appliance(s) following manufacturer's instructions.
- When appliance is not in use, keep the cylinder valve closed.

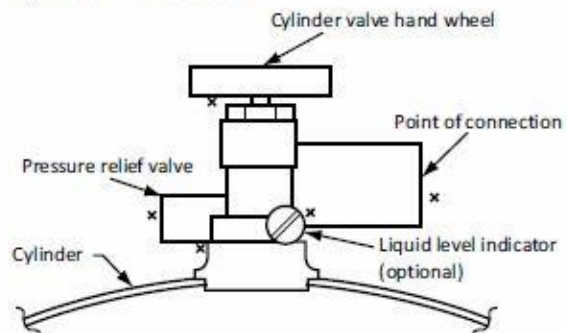

**DO NOT REMOVE, DEFACE, OR OBLITERATE THIS LABEL**  
**\*EXCEPT AS AUTHORIZED BY ANSI/NFPA 58.**

**⚠ DANGER.** Do not store a spare LP cylinder under or near a barbecue grill, or other heat sources.  
 NEVER fill an LP cylinder beyond 80% full: a fire causing death or serious injury may occur.

ce

# Table of Contents

---

 **WARNING: Improper installation, adjustment, alteration, service, or maintenance can cause property damage, injury, or death. Read the installation, operating and maintenance instructions thoroughly before installing or servicing this equipment.**

1 Important Safety Information.....	5
Technical Support.....	5
Symbol Legend .....	6
Important Safety Information for Installers.....	7
Important Safety Information for End-Users .....	8
<b>2 Remote LP Tank System Enclosure Requirements - If Applicable .....</b>	<b>9</b>
<b>3 Battery Requirements (Battery or DC Adaptor) .....</b>	<b>13</b>
<b>4 Lighting the Oven .....</b>	<b>14</b>
<b>5 First Firing.....</b>	<b>16</b>
<b>6 Forno Series Installation .....</b>	<b>17</b>

7 Troubleshooting .....23

**Important Safety Information** .....24

9 Combustible Accessories ..... 24

10 Replacement Parts .....24

11 Warranty .....25

**⚠ WARNING: If the information in this manual is not followed exactly, a fire or explosion may result causing property damage, personal injury, or loss of life.**

C Fire Inspired recommends that our products are installed by professionals locally licensed by the authority having jurisdiction in gas piping. All installation instructions must be followed to ensure proper performance and safety. HPC Fire Inspired assumes no responsibility for problems relating to the installation.

- To qualify for warranty, all instructions must be strictly followed. Otherwise, warranty may be void. Never alter product or configuration in any way.
- Annual servicing should be handled by professionals certified in the US by the National Fireplace Institute (NFI) as NFI Gas Specialists or in Canada by WETT (Wood Energy Technical Training).

• H  
P  
**INSTALLER:**  
Leave this manual with the appliance.

**END USER:**  
Retain this manual for future reference.

- It is the installer's responsibility to ensure a safe installation and to educate the end-user regarding the features, safety recommendations and proper operation of this product.
  - Please reference page 1 for all warnings.
- 

## **Technical Support**

For information and support contact your Hearth Products Controls dealer.



# Important Safety Information

**best authentic wood and gas oven on the market.**



**refractory.**

lightest available, retains heat longer, withstanding temperatures to 2400 degrees.

**stylish.**

glass mosaic tiles, robust stainless construction, everlasting materials. 3 models can be configured to a desired taste.



**vent.**

maximize heat and esthetics, no-chimney.

**electronic.**

safest ignition system, 3 volt flame sensing.

**dual fuel.**

wood and gas together. set the wood on the gas burner, turn it on, and let the wood ignite. use it simultaneously or separately  
2 sources of heat - 2 times faster heating - 2 times more control



**FIRE INSPIRED™**

# Important Safety Information

## Symbol Legend

---



### This is a Safety Alert Symbol

When you see this symbol on the fire pit insert, or in this manual, look for one of the following signal word panels alerting you to the potential for personal injury, death, or major property damage.

***Please reference page 1 for all warnings.***

## Important Safety Information for Installers

Leave this manual with the end-user and instruct them to retain it for future reference. Instructions and product updates are also available at [www.hpcfire.com](http://www.hpcfire.com) under the Support tab.

Installers must carefully follow the instructions in this manual to prevent personal injury or property loss. These instructions contain information critical to the safe installation and operation of the fire pit.

- Instructions are updated as needed. It is the responsibility of the installers to check for product updates and installation manual updates at [www.hpcfire.com/support.html](http://www.hpcfire.com/support.html) prior to installation.
- It is the responsibility of the installer to follow:
  - The National Fuel Gas Code, ANSI Z223.1/NFPA 54 or International Fuel Gas Code.
  - Natural Gas and Propane Installation Code CSA B149.1 or CSA B149.2.
  - The National Electrical Code, ANSI/NFPA 70. In Canada, Canadian Electrical Code CSA22.1.
  - Local codes
- **Control options:** Use of wall switch, optional remote control (#578-C), automatic shut-off timer or whole house system.

## Gas

- Only use the gas/fuel type specified for this fire pit, refer to the label on the fire pit control box. Never use an alternative fuel to include biofuel, ethanol, lighter fluid, or any other fuel.
- Gas pressure and type should be checked prior to use and installation.
  - **Natural Gas Fire Pit:** Supply Pressure: Minimum: 6.0 inches W.C.; Maximum: 7.0 inches W.C.
  - **LP Gas:** Supply Pressure: Minimum: 8.0 inches W.C.; Maximum: 11.0 inches W.C.

# Important Safety Information

---

## IMPORTANT

If pressure is low, this will reduce flame height on HIGH setting, resulting in little to no flame variation.



### WARNING

- **DO NOT** move oven while it is operating or hot.
- **Keep outdoor cooking gas appliance area clear and free of combustible materials, gasoline or other flammable vapors or liquids.**



### WARNING

- **DO NOT** lean on oven.
- **NEVER** use lighter fluid in the oven.
- **Oven is hot when in use; to avoid burns, DO NOT touch hot oven parts or surfaces. Keep children and pets away from hot oven.**
- **NEVER** leave the oven unattended while it is in use.
- **It is your responsibility to assemble and store, operate, and care for your gas oven properly.**
- **Do not vent propane vapors from the cylinder before taking it to be refilled.**
- **Do not use oven indoors or store any propane cylinder indoors, including in the garage, breezeways, sheds, or enclosed areas.**
- **Under some circumstances, propane may lose the distinctive odor that was added. Keep the service valve closed and plugged or capped (as recommended by the manufacturer) when the cylinder is not connected to the appliance including “empty” cylinders, Other strong odors may hide or mask the odor of propane. Colds, allergies, sinus congestion and the use of tobacco, alcohol or drugs may impair your ability to detect the odor of propane.**

The oven is not to be installed in or on a recreational vehicle and/or boat.

#### Consider when installing:

1. Always maintain a minimal clearance of 24 inches or 60 cm from all sides of oven to any combustible construction.
2. Minimum clearance of most superior part of oven opening to any combustible material immediately above the oven's opening; including attached roof overhang/soffit connected to a building is 36 inches. Do not obstruct the flow of combustion and ventilation air.
3. Keep the ventilation opening(s) of the cylinder enclosure free and clear from debris.

# Remote LP Tank System Enclosure Requirements - If Applicable

## IMPORTANT

Locate the hose out of pathways to avoid accidental damage and prevent it from becoming a trip hazard.

For an enclosure using an LP tank system, follow these recommended specifications:

- You must follow local codes.
- One side of the enclosure shall be completely open: OR
- For an enclosure having four sides, a top, and a bottom:
  - At least two ventilation openings shall be provided in the side walls of the enclosure, located within 5 inches (127mm) of the top of the enclosure, equally sized, spaced at a minimum of 180 degrees, and unobstructed. The opening(s) shall have a total free area of not less than 1 in<sup>2</sup> lb. (14.2 cm<sup>2</sup>kg) of stored fuel capacity. See Figure 6.1.
  - Ventilation opening(s) shall be provided at the floor level of the enclosure and shall have a total free area of not less than 1/2 in<sup>2</sup> lb. (7.1 cm<sup>2</sup>kg) of stored fuel capacity. If ventilation openings at floor level are in a side wall, there shall be at least two openings. The bottom of the openings shall be 1 inch (25.4mm) or less from the floor level and the upper edge no more than 5 inches (127mm) above the floor level. The openings shall be equally sized, spaced at a minimum of 180 degrees and unobstructed. See Figure 6.1.
- Every opening shall have minimum dimensions to permit the entrance of an 1/8-inch (3.2mm) diameter rod.

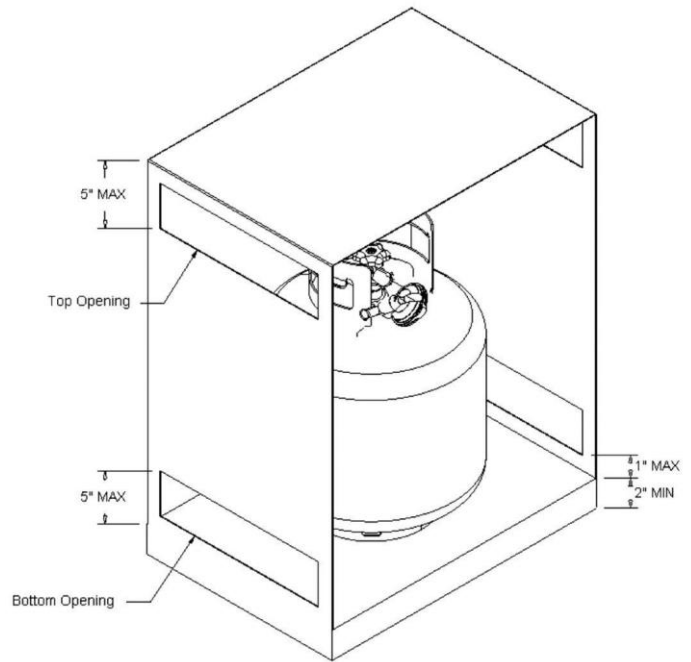

Figure 6.1 – Top and bottom side ventilation openings for LP tank enclosure.

## Remote LP Tank System Enclosure Requirements - If Applicable

---

- Ventilation openings in sidewalls shall not communicate directly with other enclosures of the appliance. See Tables 6.1 and 6.2.

LP Tank Size	Top Opening	Bottom Opening
20 LB (9.1 KG)	20 in <sup>2</sup> (130 cm <sup>2</sup> )	10 in <sup>2</sup> (65 cm <sup>2</sup> )
30 LB (13.6 KG)	30 in <sup>2</sup> (195 cm <sup>2</sup> )	15 in <sup>2</sup> (100 cm <sup>2</sup> )

Table 6.1 – LP tank enclosure opening specifications by tank size.

LP Tank Enclosure Specifications
2 Openings for each top and bottom - 180° apart
From LP tank base to bottom of opening - Max. 1" (25.4mm)
From floor to base of LP tank - Min. 2" (50.8mm)

Table 6.2 – LP tank enclosure opening specifications.

- The cylinder valve shall be readily accessible for hand operation. A door on the enclosure to gain access to the cylinder valves is acceptable, provided it is non-locking and can be opened without the use of tools. Designs using a cover to gain access to the cylinder and cylinder valve shall be provided with handles or the equivalent at a minimum of 180 degrees apart to facilitate lifting of the cover.
- The enclosure for the LP-gas cylinder shall isolate the cylinder from the burner compartment to provide:
  - Shielding from radiation.
  - A flame barrier; and
  - Protection from foreign material.
- There shall be a minimum clearance of 2 inches (50.8mm) between the floor of the non-disposable LP-gas cylinder enclosure and the ground.
- The design of the enclosure shall be such that:
  - A non-disposable LP-gas cylinder can be connected, disconnected, and the connections inspected and tested outside the cylinder enclosure; and
  - Those connections, which could be disturbed when installing the cylinder in the enclosure, can be leak-tested inside the enclosure.

# Remote LP Tank System Enclosure Requirements - If Applicable

---

## Propane Cylinder: Safety Requirements

- This appliance has been designed for use with a 20-lb. or 30-lb. size propane cylinder (not supplied).
- The propane cylinder should be checked by your propane supplier prior to installation and use.
- Never use a cylinder with a damaged valve. A worn cylinder may be hazardous and should be checked by your propane supplier.
- Use only a propane supply cylinder constructed and marked in accordance with the specifications for LP gas cylinders by the National Standard of Canada, CAN/CSA B339, Cylinders, Spheres and Tubes for Transportation of Dangerous Goods; and Commission, as applicable or the Specifications for LP-Gas Cylinders of by the U.S. Department of Transportation (DOT).
- Do not store a spare LP-gas cylinder under or near this appliance.
- Never fill the cylinder beyond 80 percent full.
- Only use the pressure regulator and hose assembly provided with this appliance or replacement pressure regulators and hose assemblies as specified by the manufacturer. The regulator supplies a pressure of 11 inches water column to the appliance and has a QCC1 type fitting.

### Propane cylinder specifications

- The propane cylinder must be provided with a cylinder connection device compatible with the connection for outdoor appliances.
- The propane cylinder must be supplied with a shut-off valve terminating in a propane cylinder valve type QCC1 and include a collar to protect the cylinder valve. A QCC1 cylinder has a positive seating connection, which will not allow gas to flow until a positive seal has been achieved. It is also equipped with an excess flow device. To attain full flow to the appliance, the valve must be in the off position when the cylinder valve is turned on.
- The propane cylinder must have a safety relief device having direct communication with the vapor space of the cylinder.
- The cylinder supply system must be arranged for vapor withdrawal.
- The cylinder shall incorporate listed overfill protection device (OPD).

## Remote LP Tank System Enclosure Requirements - If Applicable

---

### Securing the LP tank:

1. Fasten the L-bracket to the bottom of the propane tank using the nut and bolt (supplied). Ensure the nut is tight and will not loosen.
2. Select the location for the propane tank following the guidelines above, Figure 6.2.
3. Screw the bracket to the mounting surface. For concrete surface, use a concrete anchor (not supplied). Ensure that screw is tight so that the cylinder cannot move.

### Connecting the Cylinder:

1. Ensure the gas regulator has no kinks and is smooth.
2. Remove the cap or plug from the cylinder fuel valve.
3. Insert the black QCC1 regulator nipple onto the QCC1 fuel valve and tighten until snug. Do not use tools.
4. Perform a leak test on all joints prior to using the gas appliance. A leak test must be performed annually and each time a cylinder is hooked up or if a part of the gas system is replaced.
5. Follow the instructions for natural gas hook-up if the appliance is to be connected directly to a house propane gas supply line.



### WARNING

Failure to follow location and mounting guidelines for the LP tank could result in severe injury.



### WARNING

- Locate the LP Tank and enclosure out of pathways to avoid accidental damage and prevent them from becoming a trip hazard.
- Locate the hose out of pathways to avoid accidental damage and prevent it from becoming a trip hazard.



### WARNING

- Always ensure L-bracket is securely fastened to prevent the LP tank from tipping.

### INSTALLATION

We suggest that our products be installed by professionals that are locally licensed by the authority having jurisdiction in gas piping.

## Battery Requirements (Battery or DC Adaptor)

---

**NOTE:** This appliance is equipped with a low voltage electronic ignition system. The electronic ignition requires 3 Volts DC. It can either be supplied by an 110v to 3v transformer adaptor or 2 D cell batteries (in case electrical supply cannot be supplied).

Battery powered use 2 D cell batteries:

Please follow built in instruction requirement picture for location of 110v 15-amp GFCI outlet. (Outlet should be located on left side of oven base minimum 12 -18 inches from oven's hearth). You must follow all National Electrical Code regulations. In addition, be aware of local codes and ordinances when installing your service.



**IMPORTANT**

Do not ground to a gas pipe.

**IMPORTANT**

Keep the power supply cord and fuel hose away from hot surfaces.

Upon installation of electrical outlet and oven installation, plug in outlet 3volt transformer and proceed with installation.

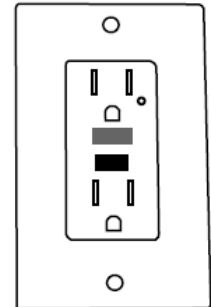



## IMPORTANT INFORMATION:

MINIMUM CLEARANCES TO COMBUSTIBLE AND NON-COMBUSTIBLE CONSTRUCTION.

ABOVE OVEN OPENING CLEARANCES MIN 36" COMBUSTIBLES AND NON-COMBUSTIBLES

COMBUSTIBLES DOOR OPENING : SIDES 12"

ADEQUATE CLEARANCE MUST BE PROVIDED FOR AIR OPENINGS INTO THE COMBUSTIONCHAMBER, FOR SERVICING AND PROPER OPERATION THE BOTTOM HALF OF THE OVEN SHOULD STAY OPEN. THIS WILL ALLOW FOR PROPER COMBUSTION AIR INTO THE BURNER HOUSING. **NOT HAVING PROPER COMBUSTION AIR WILL CAUSE IMPROPER OPERATION AND MAY CAUSE DAMAGE TO THE BURNER SYSTEM.**

KEEP APPLIANCE FREE AND CLEAR FROM COMBUSTIBLES.

DO NOT OBSTRUCT THE FLOW OF COMBUSTION AND VENTILATION AIR TO THE APPLIANCE.

ELECTRICAL AND GAS REQUIREMENTS ARE SPECIFIED FOR PROPER INSTALLATION AND USE OF OVEN.

INSTALLATION MUST CONFORM WITH LOCAL CODES, OR IN THE ABSENCE OF LOCAL CODES, WITH THE NATIONAL FUEL GAS CODE ANSI Z223.1, THE NATURAL GAS INSTALLATION CODE CAN/CGA-B149.1 OR THE

PROPANE INSTALLATION CODE CAN/CGA-149.2, AS APPLICABLE, INCLUDING:

1>>THE APPLIANCE AND ITS INDIVIDUAL SHUT OFF VALVE MUST BE DISCONNECTED FROM THE GAS SUPPLY PIPING SYSTEM DURING ANY PRESSURE TESTING OF THAT SYSTEM AT TEST PRESSURES IN EXCESS OF ½ PSI (3.45 Kpa).

2>>THE APPLIANCE MUST BE ISOLATED FROM THE GAS SUPPLY PIPING SYSTEM BY CLOSING ITS INDIVIDUAL MANUAL SHUTOFF VALVE DURING ANY PRESSURE TESTING OF THE GAS SUPPLY PIPING SYSTEM AT THE TEST PRESSURES EQUAL TO OR LESS THAN ½ PSI (3.45 Kpa).

THIS APPLIANCE, WHEN INSTALLED, MUST BE ELECTRICALLY GROUNDED IN ACCORDANCE WITH LOCAL CODES, OR IN THE ABSENCE OF LOCAL CODES, WITH THE NATIONAL ELECTRICAL CODE, ANSI/NFPA 70 OR THE CANADIAN ELECTRICAL CODE, CSA C22.1, AS APPLICABLE.

ELECTRICAL AND GAS REQUIREMENTS:

-1 120VAC – 2.5 AMP OUTLET

- ½ INCH GAS OUTLET

-GAS INLET PRESSURE TO OVEN: 7" W.C. FOR NATURAL, 10" W.C. FOR LP GAS

# Lighting the Oven

This oven is equipped with an electronic ignition system. This system can operate with 2 D batteries, or it can be used with a 3-volt DC adaptor. The batteries should last between 6 months to 1 year depending on use and where the oven is placed (extreme heat and cold temperatures will decrease the life of the batteries). Please check battery frequently to make sure its appearance is normal. We recommend battery replacement every 1 year from time of purchase. HPC Hybrid Oven also has an adaptor that can be used to electronically ignite the pilot and operate the oven gas burner. This adaptor must be plugged in an 110v GFCI outlet.

The oven's gas burner will not operate unless the safety pilot is on.

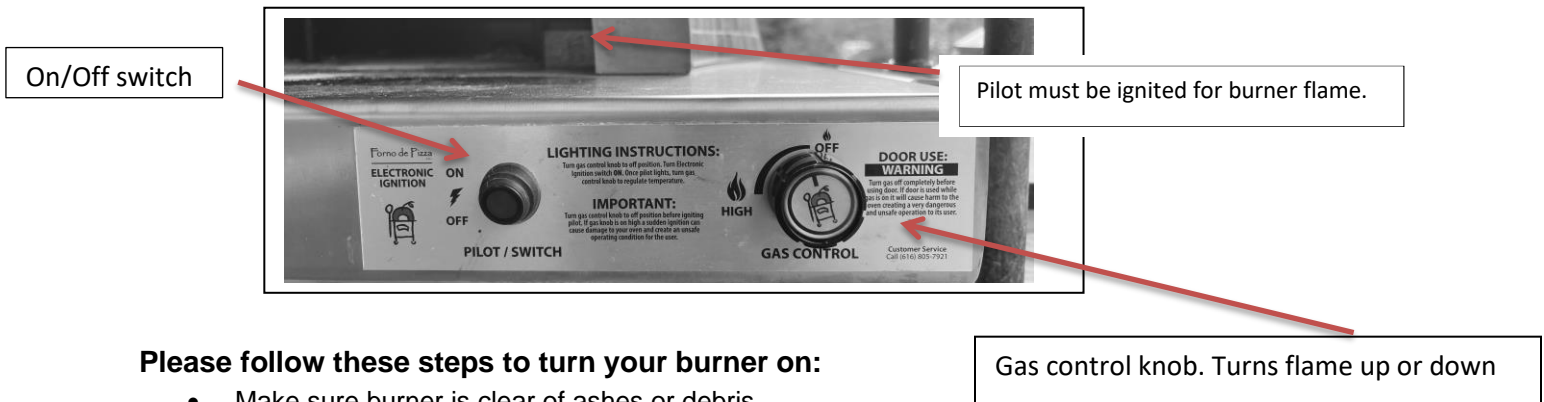

## Please follow these steps to turn your burner on:

- Make sure burner is clear of ashes or debris.
- Make sure valve control valve is on off position.
- Turn on valve on LP cylinder or natural gas shut off valve
- Turn valve in the oven control panel to off position.
- Turn electronic igniter switch to ON. It might take 30 to 60 seconds for gas to travel from tank to pilot the first time you start your oven)
- Once pilot is lit, turn the gas control knob from OFF position slowly to regulate burner flame.
- Turn gas regulator knob to OFF and place small pieces of dried hardwood on burner. Regulate gas flame so wood can ignite. Leave gas on.
- Once wood has ignited and smaller pieces of coals have formed, with the back of brush push wood to center of oven to heat the hearth. Then place more wood on top of coals.
- Leave the gas line ON. It will do a couple of things
  1. Keep the oven hot and the flame steady
  2. Keep the smoke to a minimum

(If you have too much smoke because the fire is dying, wood is wet or not enough wood – try turning the gas up a bit, it usually burns off the smoke.)

- Your oven should be hot enough to bake a pizza in about 30 min. (obviously cooler temperatures take a bit longer) the use of our insulating blanket should also help with heat retention.)
- Distinct locations in the oven heat up differently – The hearth at its hottest temperature gets around 800°. Inside the dome on top-over 1000°. The outside of dome on left side (where the burner is lit) can reach about 400° The dome on the opposite side of the burner can reach about 300°.

## Lighting the Oven

---

- A clever way to test the hearth to see if it is hot enough to bake a pizza – throw some flour on hearth and it should burn within 1-2 seconds. If not, then with brush bring the wood back to center of oven, add more wood and let it burn hotter. Then move it to the back of the oven.
- Brush center of the hearth
- Place pizza on hearth and turn pizza ¼ turn every 30 seconds or watch for golden brown on cheese and dough.
- Remove pizza and enjoy.

### To Use as a Grill

- Follow same steps to start oven and hearth
- Place disposable aluminum pan on hearth to catch grease.
- Insert grill rack with a hot pad/mittens
- Add grill rack to oven (It is a clever idea to spread some olive oil on the grill rack top before putting it in the oven.)
- Add food – Watch it sizzle
- Remove. Enjoy.
- If your food does not need a grease pan, you can leave ambers on hearth and slide grill rack on top of it.
- You may grill, bake, or use a skillet on top of the rack. The possibilities are endless.
- We suggest the use of an infrared thermometer if you want to do more detailed temperature control like breads and chicken.
- We suggest baking bread in the front of the oven where the temperature is around 300-400°.
- We suggest smoking after cooking is complete. Close the door and let the fire die out. Adding some of your favorite smoking wood chips to the “died-out fire” will create smoke in the oven and it will remain circulating inside the oven. Smoking should be done at lower temperatures. Oven door temperature gauge should be pretty accurate in displaying oven temperature.
- Heat control can be achieved by decreasing the amount of wood, decreasing gas, closing the door (Door works as a damper-less oxygen entering oven, less fire).



#### **CAUTION**

**Never place door without door vent whenever gas is turned on. It might cause an explosion. If smoking, remove door vent turn gas completely “off” at gas control knob and at the LP tank/shut off valve.**

You may also bake bread in the oven. Turn on gas and leave door half open. Regulate heat. Bake.

- Whenever you are done using oven, make sure LP tank is off and let oven cool down.
- Do not place outdoor cover on till oven has cooled down.
- Careful! Door will be hot. Only touch the wooden handle.

# First Firing

***Forno de Pizza ovens are constructed for optimum performance. It is important to heat the oven gradually in first firing.***

## Important:

Follow oven curing instructions to properly cure the oven.

Do not heat up the oven too quickly. It will damage the tile.



## About your refractory oven:

A refractory material is one that retains its strength at hot temperatures. Your oven's refractory material can withstand temperatures up to 2400 degrees.

Unlike other ovens in the industry that are multi-pieced and joined together with mortar, your oven is shaped as one piece allowing it to be moved maintaining its shape and aesthetics of a century's old oven.

This shape enables the best functional heat distribution in the oven. Its two-inch wall thickness reflects enough heat back to the inside of the oven, and the temperature on the outside of the oven remains one third of the inside temperature, optimizing heat retention.

## 3 heat sources and temperatures that exceed 1000°

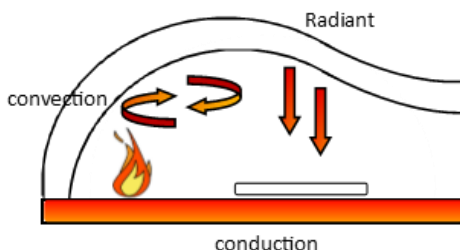

Please scan this QR code for video:

HOW TO CURE YOUR OVEN -1<sup>ST</sup> FIRING



## Your oven's first firing:

**First time firing**-heat up with gas only.

1. Start with a 1/2 inch extremely low flame on the gas burner for 2 hours.
2. Raise flame to 1 1/2 inch in size for 1 hour.
3. Increase flame to 2 1/2 for 1 hour
4. Stoke with kindling on the burner to continue to raise oven's temperature for another 1 hour
5. Do not use door during first firing
6. Complete at least 5 hours for the first firing

## Essential information:

Once your oven is poured and removed from its mold, it goes through a drying process that allows water to evaporate. Glass is mortared using a proprietary formula that will withstand the high heat generated during normal operation. To properly cure the glass to the oven a heat up schedule should be properly performed. During your first oven firing, small water molecules that remained trapped in the refractory during the drying process will come out in a vapor form.

## WOOD-OAK-ONLY!

Simple and important for proper operation.

-Use at least 1 year dried, debarked 1 1/2-to-3-inch diameter, 12- to 14-inch-long OAK. You will have consistency during operation, no smoke, no popping ambers on to your food, intense heat, and a great smell.

# Forno Series

HEARTH

CART

OVEN

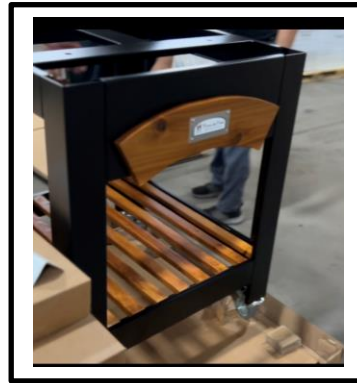

## Forno Series Installation

---

### HOW TO ASSEMBLE YOUR OVEN

Oven is heavy, please use 3 to 4 people to safely assemble your oven.

Please link this QR code for a **Video** on  
How to assemble the oven:



# Forno Series Installation

## 1. How to assemble your Forno Series

Please follow these steps to assemble your oven



2. Place **cart on ground** and lock wheels.



3. Place oven to another sturdy location  
*(so, you can unpack Hearth)*

IMPORTANT  
OVEN CURING INFORMATION

4. Important: **read oven curing information.** Follow instructions prior to first firing.



5. Four people **place hearth onto cart.** (safer with 4 people, step in box and careful not to trip over)

6. fasten **3 thumb** screws from cart to bottom of hearth

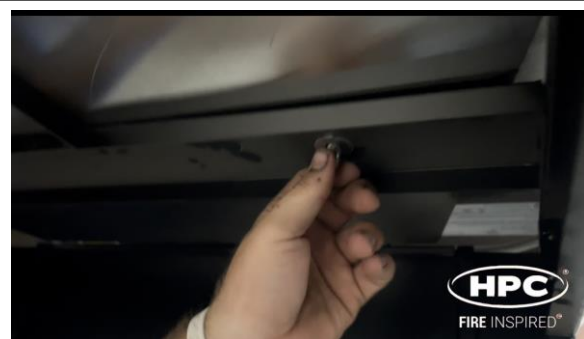

# Forno Series Installation

7. Remove **protective plastic** from hearth.



8. move oven closer to cart and **lock wheels**.

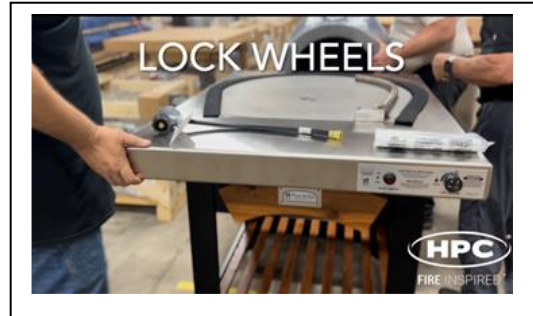

9. **Three people** move oven to hearth. Two persons on each side and third on the front.



Set back of oven on back first, then third person lift the front so other 2 can remove fingers. Then person on front can slowly lower oven onto black carbon fiber gasket.



10. **Third** person in front to lower the oven.

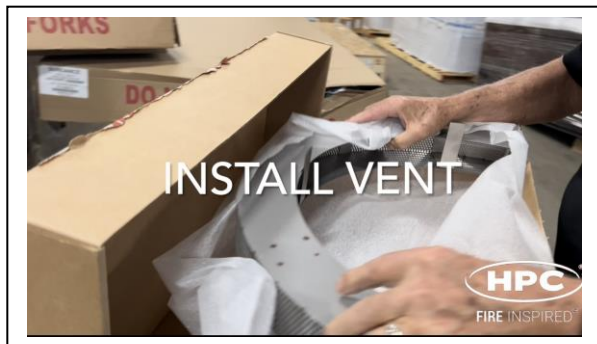

11. **Install vent** into oven opening



12. Fasten 4 oven **safety** locking screws

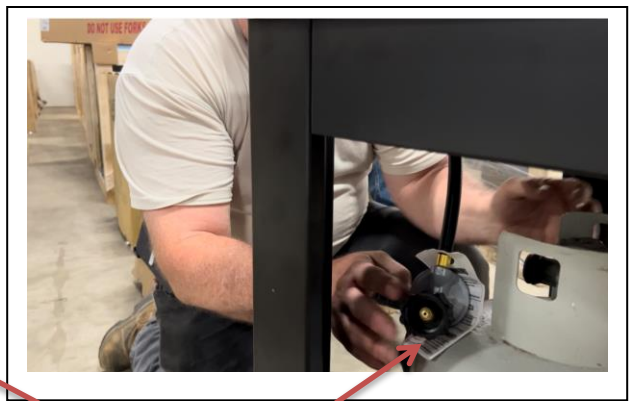
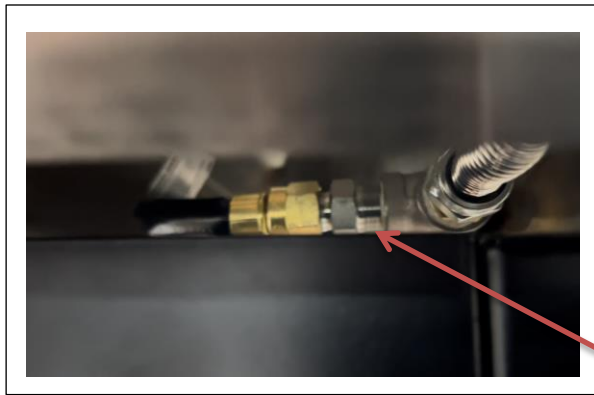

13. connect LP regulator to hearth,  
CONNECT REGULATOR TO TANK  
**check for gas leaks**

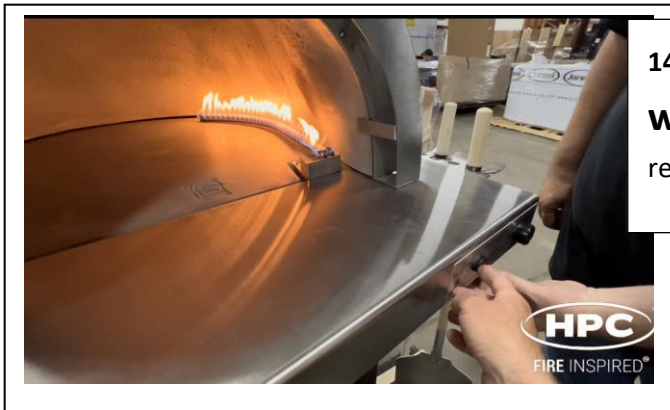

14. turn **switch to ON** and **wait 30** seconds. Once Pilot ignites regulate flame.





15. two people should **move the assembled oven carefully**. The person on the front pull and the back person pushes. Slowly and carefully.



16. Lock casters



**Your oven is ready!**

# Forno Series Installation

## Natural gas connection

- The Forno Series can be purchased to be used with natural gas.
- This connection must be done by a licensed hearth installer.
- It is important to have correct diameter gas lines for desired oven output.
- A shut off valve should be placed between the house and the oven.
- Connect an approved Natural Gas line to the right side of the oven, located on the underside of the oven hearth plate.
- Make sure all the connections are tight and comply with local codes. Turn gas shut off valve on and check for leaks.
- Follow how to start the oven instructions.

***The installation of this appliance must conform with local codes or, in the absence of local codes, with either the National Fuel code, ANSI Z223.1/NFPA54, National Gas propane Installation code, CSA B149.2. Installation in Canada must be in accordance with the standard CAN/CGA-B149.2.(Installation code for gas burning appliances and equipment) and local codes***

Natural Gas needs to be connected here.

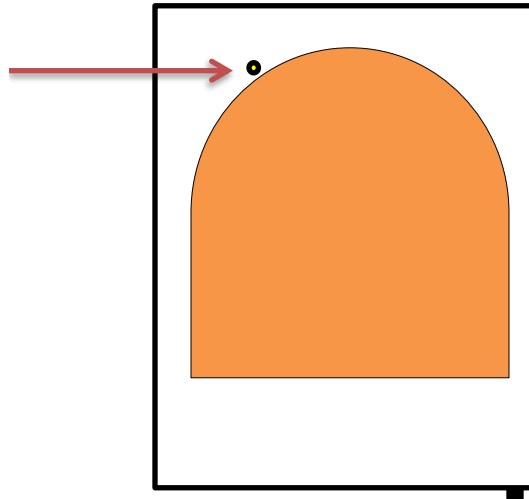

Gas pressure is affected by gas line and length of gas line from house gas line. Please follow recommendations on the chart:

Distance	Tubing size
4ft (stainless flex line) to oven connection from valve	1/2" diameter
Up to 25'	3/4" diameter
26' to 50'	1" diameter
51'to 100'	2/3 of run 1 1/4" 1/3 of run 3/4"

®



Insert vent in front of oven opening by lifting front of oven and inserting vent tabs under and around the inside of door opening. (MAKE SURE BURNER IS OFF)

*The Oven Vent enables you to use the door and burn wood and use gas while door closes the opening, like your oven at home. You may control the heat by regulating the flame on the gas burner.*

**-Do NOT touch Oven Vent. It is hot and may cause burn.**

**-Use wooden door handle to remove door, door is also hot and may cause burn.**

**VENT MUST BE INSTALLED PRIOR TO OPERATING THE OVEN. IF OVEN IS USED WITHOUT THE VENT, A VERY DANGEROUS AND UNSAFE CONDITION WILL CAUSE HARM TO ITS OPERATOR.**



### WARNING

- Door cannot be used with gas unless oven vent is in place or gas is off

# Troubleshooting

Please link this QR code  
troubleshooting videos:



## Service

**NATIONAL  
FIREPLACE  
INSTITUTE**



We suggest that our products be serviced by a professional certified in the US by the National Fireplace Institute (NFI) as NFI Gas Specialists.

Table 11.1 below indicates some potential causes and countermeasures to the symptoms indicated in bold type. **Please contact your retailer or certified technician for service and repair.**

Problem	Possible Causes	Solution
<b>Gas burner does not light up</b>	No spark	Replace your battery, make sure you have power to the oven if using adaptor Check pilot for spider webs or ashes and clear it from the pilot burner
	No gas	Make sure gas valve is open
		Make sure tank has propane and for natural gas make sure shut off valve is ON
		Tank might be empty
<b>Pilot does NOT stay lit</b>	<b>Insufficient gas (Most common in Natural gas hook-up)</b>	- (check recommended gas tubing sizes/run) if you do not have sufficient natural gas pilot will not ignite. If there is more than one appliance using gas at a time, pressure to oven might be diminished
	Debris in pilot	Ashes or spider webs can obstruct pilot not allowing it to fire- blow with a compressed air keyboard duster
<b>Too much smoke coming out of oven</b>	Wood is wet	-Make sure wood is dry and free of paint, oils, sap, varnishes
	Fire is not hot enough	Turn gas valve to high till smoke diminishes
	Oven door opening is not allowing air in to vent, thus killing fire	Make sure door opening allows enough air to burn fire (remove door)
<b>Pizza dough not cooking fast enough</b>	Hearth is not hot enough	-use infrared thermometer to check hearth temperature should be 625 to 650 degrees
	Oven temperature is low	Add wood or turn gas higher
<b>Pizza is burning</b>	Oven too hot	-let oven cool down
		Turn pizza more often
<b>Pizza is not cooking on top</b>	Pizza has too many ingredients	-Put pizza on aluminum paddle And raise it to the top of oven (it is hotter on top of the oven)
	Fire is not hot enough	Turn gas up

# Wiring Diagram

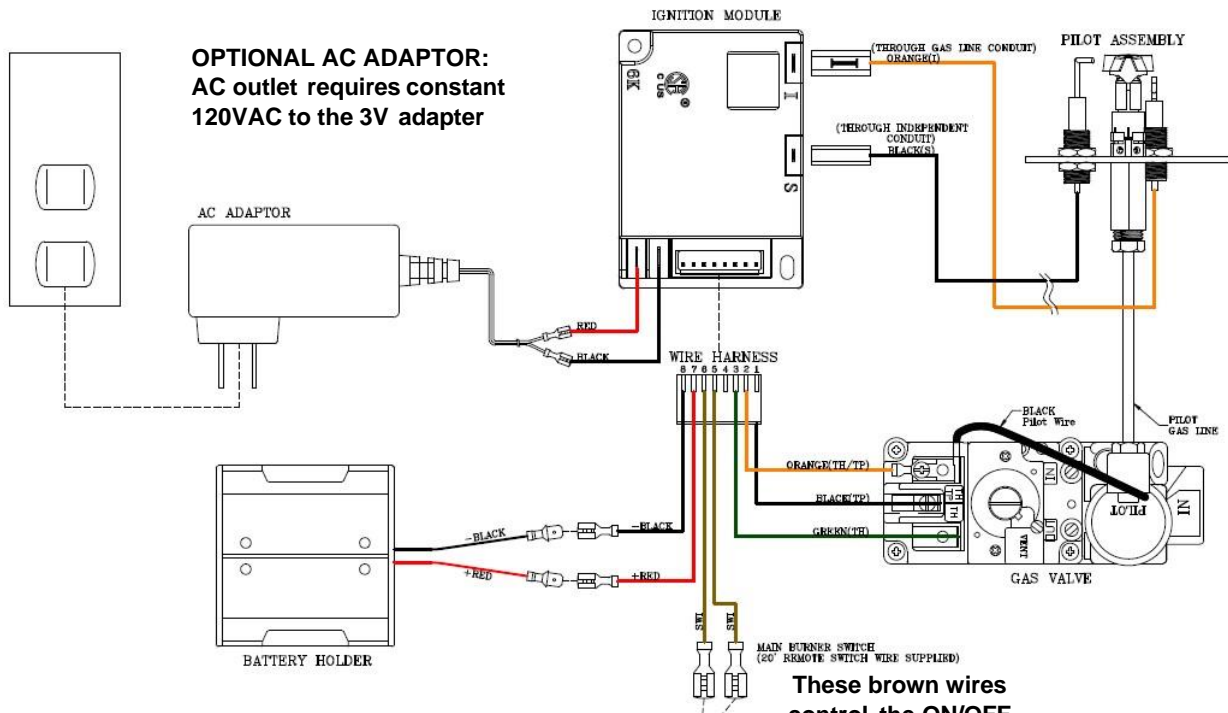

## Compatible Accessories

For a complete list of accessories, visit [www.hpcfire.com](http://www.hpcfire.com)

Please link this QR code for ACCESSORIES:



## Replacement Parts

Please contact your dealer for parts – if unsure please contact HPC Fire Inspired or visit our website at [www.hpcfire.com](http://www.hpcfire.com) and we will be happy to help you

# Warranty

---

HPC Fire Inspired warrants that for a period of two years from the original purchase, this product will be free of defects in material and workmanship. HPC Hybrid Oven, at its option, will repair or replace this product or component of the product found to be defective during the warranty period. Replacement will be made with new or remanufactured product or component. If this product is no longer available, replacement may be made with a similar product of equal or greater value. This is your exclusive warranty.

This warranty is valid for the original retail purchaser from the date of the initial purchase and is not transferable. Keep the original sales receipt. Proof of purchase is required to obtain warranty performance. HPC Fire Inspired dealers, service centers, or retail stores selling HPC Fire Inspired do not have the right to alter, modify or in any way may change the terms and conditions of this warranty. This warranty does not cover normal wear on parts or damage resulting from any of the following: negligent use or misuse of the product, improper handling, use on improper voltage or current, and use contrary to the operating instructions, improper disassembly, repair, or alteration by anyone other than HPC Fire Inspired or an authorized service center. Further, the warranty does not cover the improper use of gas and subsequent explosion or poisoning due to gas exposure, Acts of God, such as fire, flood, hurricanes, and tornadoes. HPC Hybrid Oven's two-year warranty only applies for the oven in residential use.

With extreme temperature fluctuation in oven cracks will form on the oven but should not affect its performance and or break the oven apart. These cracks are to be expected HPC Fire Inspired cannot warranty a crack free oven. Oven replacement is not included due to cracks. Improper heating or handling of the refractory material can affect the oven's integrity and HPC Hybrid Oven is not responsible for cracks in the refractory material larger than one eighth of an inch. If cracks become larger than one eighth of an inch, please contact HPC Fire Inspired for repairing instructions or servicing. Please contact HPC Fire Inspired if you do not understand your warranty or the instructions on how to use the oven. HPC FIRE INSPIRED SHALL NOT BE LIABLE FOR ANY INCIDENTAL OR CONSEQUENTIAL DAMAGES CAUSED BY THE BREACH OF ANY EXPRESS OR IMPLIED WARRANTY OR CONDITIONS. SOME STATES, PROVINCES OR JURISDICTIONS DO NOT ALLOW THE EXCLUSION OR THE LIMITATION OF INCIDENTAL OR CONSEQUENTIAL DAMAGES, SO THE ABOVE LIMITATION OR EXCLUSION MAY NOT APPLY TO YOU. EXCEPT TO THE EXTENT PROHIBITED BY THE APPLICABLE LAW, ANY IMPLIED WARRANTY OF MERCHANTABILITY OR FITNESS FOR A PARTICULAR PURPOSE IS LIMITED IN DURATION TO THE DURATION OF THE ABOVE WARRANTY OR CONDITIONS. SOME STATES, PROVINCES OR JURISDICTIONS DO NOT ALLOW LIMITATIONS ON HOW LONG AN APPLIED WARRANTY LASTS, SO THE ABOVE LIMITATIONS MAY NOT APPLY TO YOU. This warranty gives you specific legal rights, and you may also have other rights that vary from state to state or province to province.



**FIRE INSPIRED®**

Inspired by safety.  
Innovated for your lifestyle.

**Hearth Products Controls**

2225 Lyons Road  
Miamisburg, OH 45342

For detailed product information, go to  
[www.hpcfire.com](http://www.hpcfire.com)