



ECHELON

DIAMOND SERIES

GAS GRILLS



RHP CONNECT APP Setup & Operation

GETTING STARTED

VERIFY COMPATIBILITY

The app and touch-controlled digital thermometer is offered with select Fire Magic Echelon Diamond Grills, and is compatible with select electronic devices. See Table 1 and Table 2.

Product	Models
Echelon Diamond Grill equipped w/ under glass digital thermometer	E660, E790, E1060

Table 1 - Appliance Compatibility

Electronic Device Operating System Requirements
iOS 11.0 or higher
Android v10.0 or higher

Table 2 - Electronic Device Requirements

INSTALL ECHELON DIAMOND GRILL

If not already done, follow the instruction manual provided with your grill for proper installation.

Then proceed to the following APP SETUP section.

DOWNLOAD AND INSTALL RHP CONNECT APP

Visit <https://www.firemagicgrills.com/digital-touch-control/>
or simply scan the QR code on the right.



Before setting up, ensure the RHP CONNECT app is downloaded and installed. Visit <https://www.firemagicgrills.com/digital-touch-control/> to download.

CREATE AN ACCOUNT

Note: This app setup process must be repeated for each device in the household that will be used for operation. To download and install the "RHP Connect" app, scan the QR code on the previous page, visit the link above, or search for "RHP Connect" in your app store (see Fig. 2-1 for app logo). Then follow the prompts on your screen to create an account. See Fig. 2-2 through Fig. 2-4 for details.

- You will receive an e-mail with a confirmation code; please check junk/spam folders in case the e-mail gets blocked.
- For select devices, you can sign in using external platforms such as Google or Facebook.



Fig. 2-1
Download RHP Connect

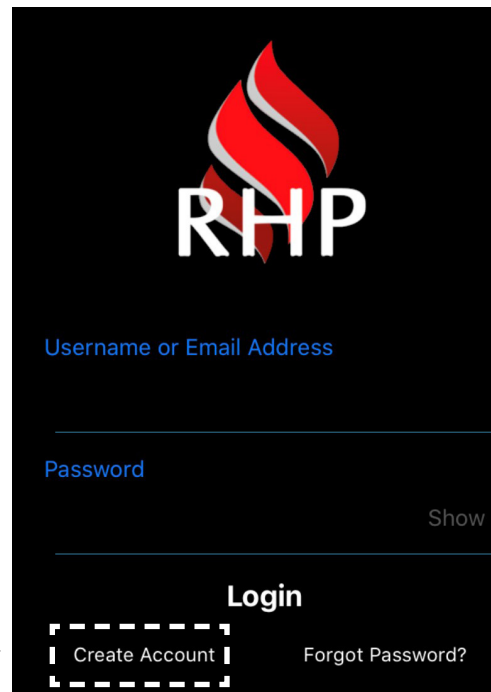

Fig. 2-2 Select create account / sign up

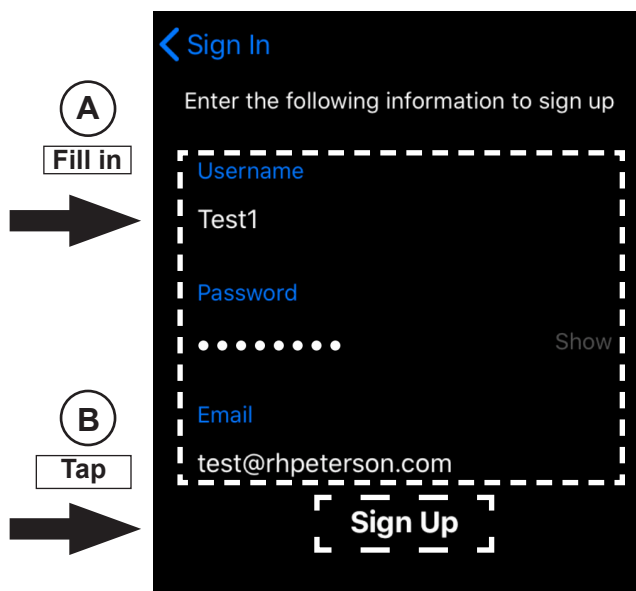

Fig. 2-3 Fill out screen and sign up

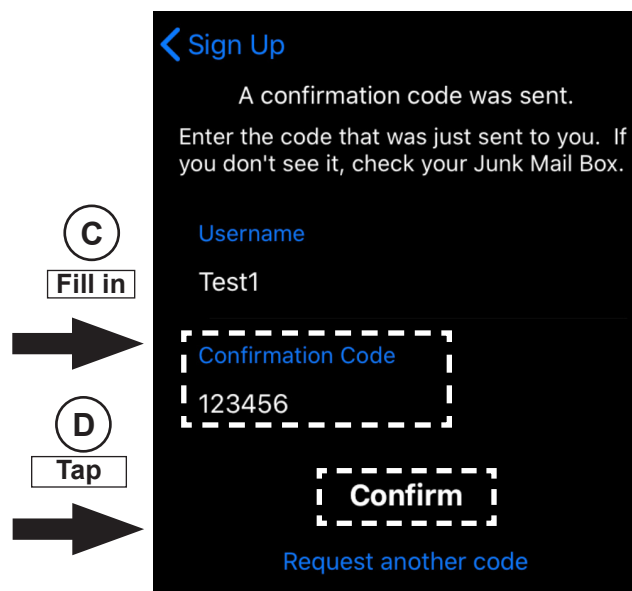

Fig. 2-4 Confirm sign up

CREATE AN INITIAL ZONE

Once your account is created, proceed to the "Zones" screen, and if needed tap the ⊕ icon to enter the "New Zone" screen as shown below. Fill in the "Enter Location" field. The other fields will auto-fill. Then tap "Save Zone". Proceed by tapping on the newly created zone. See Fig. 3-1, Fig. 3-2 and Fig. 3-3 for details.

Note: It is recommended you allow RHP Connect to access your location for full functionality of the app.

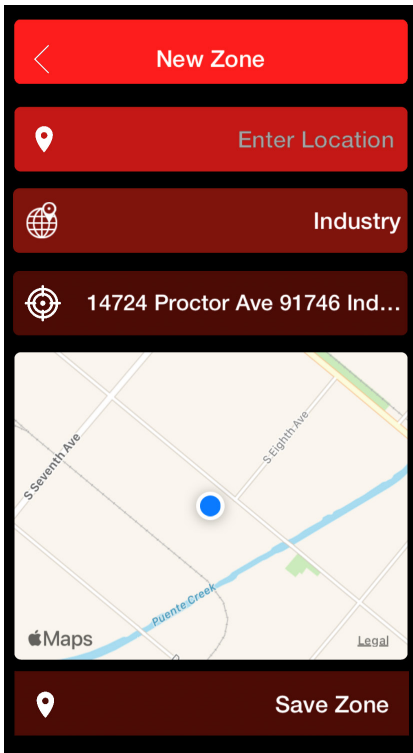

Fig. 3-1 Create zone

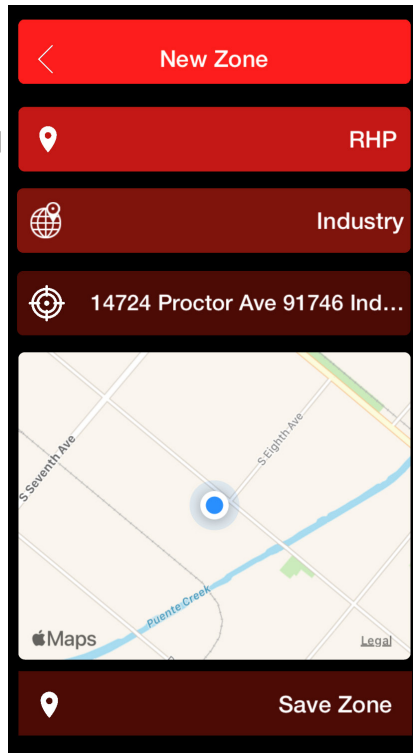

Fig. 3-2 Save zone

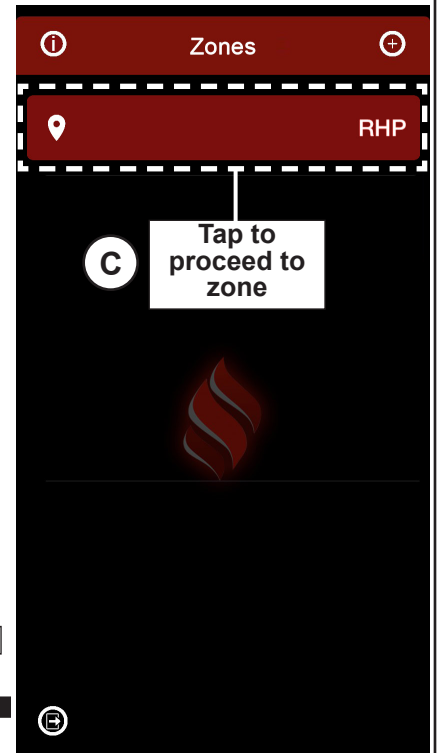

Fig. 3-3 Proceed to zone

APP SETUP (Cont.)

ADD YOUR DEVICE

1. Press the **THERMOMETER POWER SWITCH** on the grill control panel (See Fig. 4-1). The grill digital display will illuminate.
2. Hold your device up against the grill display screen (See Fig. 4-2), then follow the prompts to pair the grill to the app.
3. Fill in the fields as needed. Then tap "**Connect**". See Fig. 4-3 and Fig. 4-4.
4. Tap on your grill under the "Devices" screen (see Fig. 4-5). The app will proceed to the app main screen.

Your app is now ready to use with the grill. Proceed to the APP OPERATING INSTRUCTIONS section.

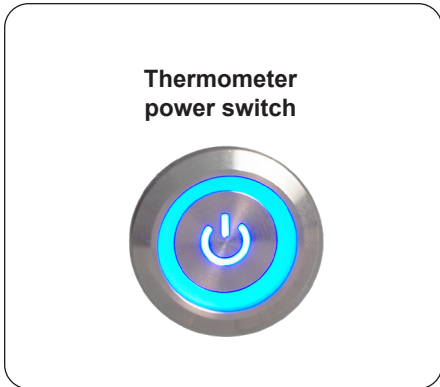

Fig. 4-1 Turn on Thermometer



Fig. 4-2 Tap device against grill display screen

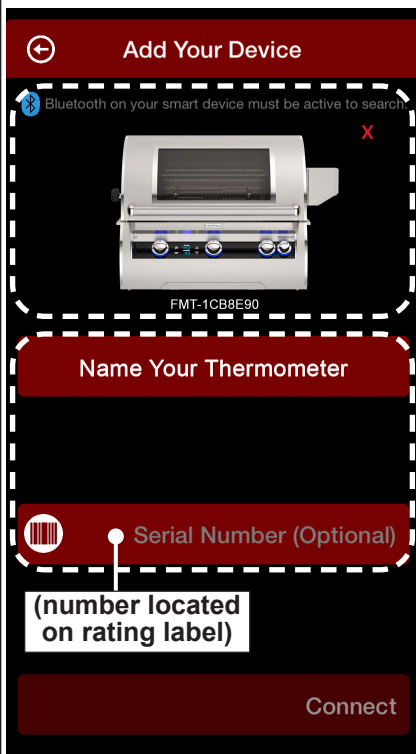

Fig. 4-3 Add your device

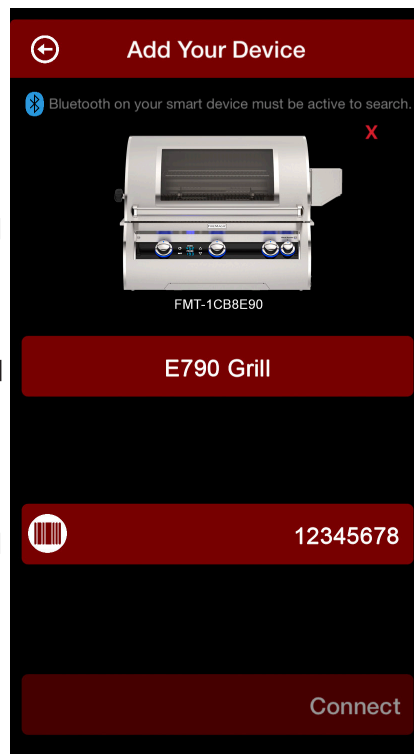

Fig. 4-4 Confirm connection

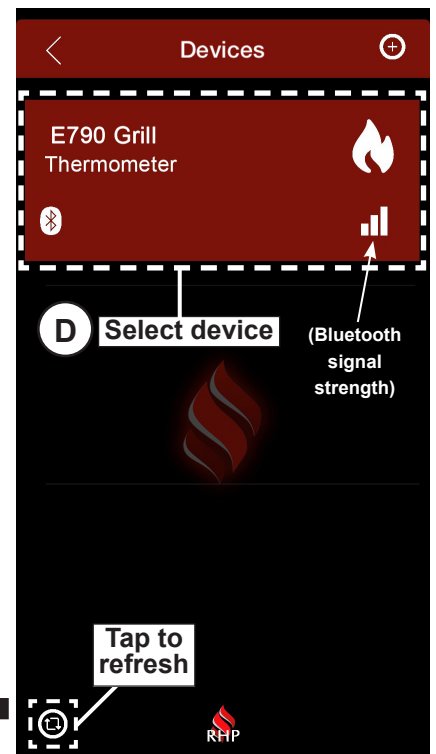

Fig. 4-5 Select device

APP OPERATING INSTRUCTIONS

BEFORE USE

Ensure that the grill is properly installed, the power supply cord is plugged in, the power source is turned on, the RHP connect app is setup on your electronic device, and your grill digital control(s) are successfully paired with the RHP CONNECT app.

Ensure that you have read all instructions completely and carefully prior to product use. Refer to them as needed.

Note: The digital controls on the grill are bluetooth and wifi enabled. Bluetooth has a max range operation of up to 30 feet (range may vary between device model/version). To extend the range of operation, the device can be connected to wifi. See the CONNECT TO WIFI section to setup.

Note: When using Bluetooth, the unit can be controlled by only one electronic device at a time, whereas connecting via wifi enables two devices to simultaneously operate the unit.

For best user experience and to update thermometer firmware version, it is recommended to connect the thermometer to wifi. See the CONNECT TO WIFI section for details.

FOR YOUR SAFETY, READ BEFORE LIGHTING THE GRILL

WARNING: IF YOU DO NOT FOLLOW THESE INSTRUCTIONS AND ALL INFORMATION FOUND IN THE GRILL OWNER'S MANUAL, A FIRE OR EXPLOSION MAY RESULT, CAUSING PROPERTY DAMAGE, PERSONAL INJURY, OR LOSS OF LIFE.

- A.** The lighting of this appliance is only to be done using the control knobs on the grill. **This app does not operate the grill flames/temperature.**
- B. BEFORE LIGHTING**, smell all around the appliance area for gas.
- C. IF YOU SMELL GAS** (and all control knobs are in the OFF position), immediately shut off the gas supply and contact a qualified professional service technician or the gas supplier for inspection.

Operation continued on next page

APP OPERATING INSTRUCTIONS (cont.)

For complete details regarding the digital thermometer featured on the Echelon Grill, see the grill owner's manual.

LIGHT THE GRILL

Before using the app, first light the grill per the lighting instructions found in the grill owner's manual, then proceed below to use the app with your grill.

POWER ON GRILL DIGITAL THERMOMETER

To utilize the app alongside the grill, the digital thermometer must first be manually turned on. The grill thermometer power switch is located on the right side of the control panel.

1. Press the **thermometer power switch** (see Fig. 6-1). The digital thermometer display and touch-controls will illuminate.
2. Now that the thermometer is turned on, the grill readings will display on the app. See Fig. 6-2 and Fig. 6-3.
 - The readings on the app update every 5 seconds.

WARNING: The grill burners ON/OFF status must be verified in person – it is an attended appliance.

CAUTION: THIS APP AND THE DIGITAL THERMOMETER (ON THE GRILL) DO NOT CONTROL THE GRILL BURNERS. The grill burners can only be controlled via the control knobs.

POWER OFF GRILL DIGITAL THERMOMETER

Press the thermometer power switch on the grill control panel (see Fig. 6-1) to power OFF the digital thermometer. The switch **MUST** be in the OFF position when the grill is not in use.

SET OVEN TEMPERATURE

Set the oven temperature by tapping on the **Oven Set** button. Input in the desired temperature, then tap **Done**.

- The temp. display will climb until it reaches the set temperature. Once reached, a notification will display on the screen, the device will vibrate and ring, and the grill controls will start flashing and the alarm will sound. Follow the prompts on the screen to silence.

Note: Notifications may vary between device models and/or notification settings on the device's operating system.



Thermometer power switch

Fig. 6-1 Turn on digital thermometer

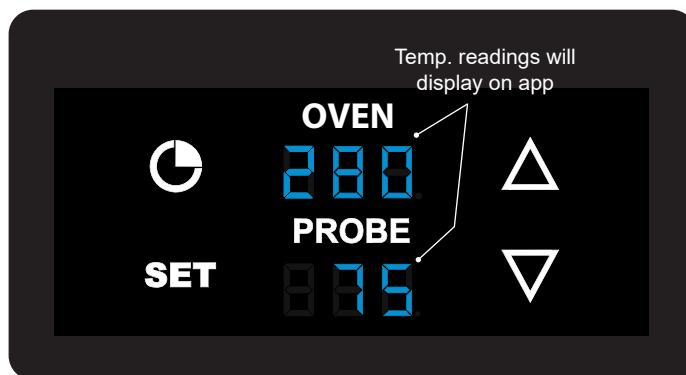

Fig. 6-2 Grill display readings



Fig. 6-3 Temp readings on app

MEAT PROBE

The probe jack is located on the right side of the control panel. Connect the meat probe to the probe jack. The probe temperature will display. At this point, the meat probe can be inserted into the meat for temperature monitoring.

For complete details about your meat probe, see the grill owner's manual under the DIGITAL THERMOMETER section.

To set the meat probe temp/alarm:

Tap on the **Probe Set** and input your desired temperature (see Fig. 7-2, A). Tap **Done** to confirm. The target temp will be shown on the probe set display.

The probe is calibrated specifically for use at temperatures between 125°F and 180°F. Do not set the probe outside of those parameters.

SETTING THE TIMER

Set the timer by tapping on the **Timer** display. Input the desired time, then tap **OK** (see Fig. 7-1, B).

- The timer will start and the count down will show on the Timer display.
 - The timer displays in the format of Minutes:Seconds (00:00). See Fig. 7-1.
 - Once the timer reaches zero, a notification will display on the screen, the device will vibrate and ring, and the grill controls will start flashing and the alarm will sound. Follow the prompts on the screen to silence.
- Note:** Notifications may vary between device models and/or notification settings on the device's operating system.
- The timer can be set at a maximum of three hours.

GRILL GUIDE

The grill guide serves as a convenient point of reference during cooking, and when the meat probe is connected, you may choose a temperature from the grill guide and it will set it to the meat probe temp/alarm.

1. From the main screen, tap on **Grill Guide**.
2. Tap on the desired temperature, then tap **OK** to confirm. See Fig. 7-2.



Fig. 7-1 Meat probe and timer



Fig. 7-2 Grill guide

APP OPERATING INSTRUCTIONS (cont.)

CONNECT TO WIFI

Connecting the app to a wifi network (2.4 GHz only) will extend the range for a better grilling experience. Before setting up wifi, ensure your electronic device is already connected to the wifi network.

Important: Ensure your grill is within range of the wifi signal.

1. From the main screen, tap on the **Settings** icon.
2. Verify the wifi name displaying in the app is correct.
3. Type in the wifi password. If needed, clear out the dots before typing in the password.
4. Tap **OK**. It will exit the settings screen and go back to the main screen. A prompt reading "WiFi Setup Successful" will display. See Fig. 8-1.

Note: It is possible that the thermometer(s) may reboot after successfully connecting to wifi.

Note: If the *incorrect* wifi name is displayed, tap on the incorrect wifi name and select the correct wifi name from the list of available networks, input the password, then tap **OK**.

CHANGE DEGREE MODE (F°/C°)

1. From the main screen, tap on the **Settings** icon.
2. Under Degree Mode, select **F°** or **C°**, then tap **OK** to confirm. See Fig. 8-1.

NOTIFICATIONS

1. From the main screen, tap on the **Settings** icon.
2. Tap on the Notifications toggle switch to turn notifications **on** or **off**, then tap **OK** to confirm. See Fig. 8-1.

Note: Notifications may vary between device models and/or notification settings on the device's operating system.

Note: If solely operating via bluetooth, the screen on the electronic device must remain on (disable screen timeout settings on device) at all times while cooking to receive all notifications.

FIRMWARE UPDATE

1. Ensure:
 - the thermometer power switch on the grill is turned on (leave unit in "standby mode" - heat is off)
 - the grill is connected to the app
 - the app and appliance is connected to wifi (must be connected to wifi for update to work, see CONNECT TO WIFI section to setup)
 - the grill and electronic device have a strong wifi signal
2. Once all the above are confirmed, from the main screen tap on the Settings icon.
3. Under Firmware, tap on "Update".

Note: If the "Update" button is not visible, the firmware version is up to date or wifi is not connected.

ADDITIONAL SETTINGS

- The device ID number is for tech support reference.
- To rename your device name, tap on the device name, type in new name, then tap **Done**.

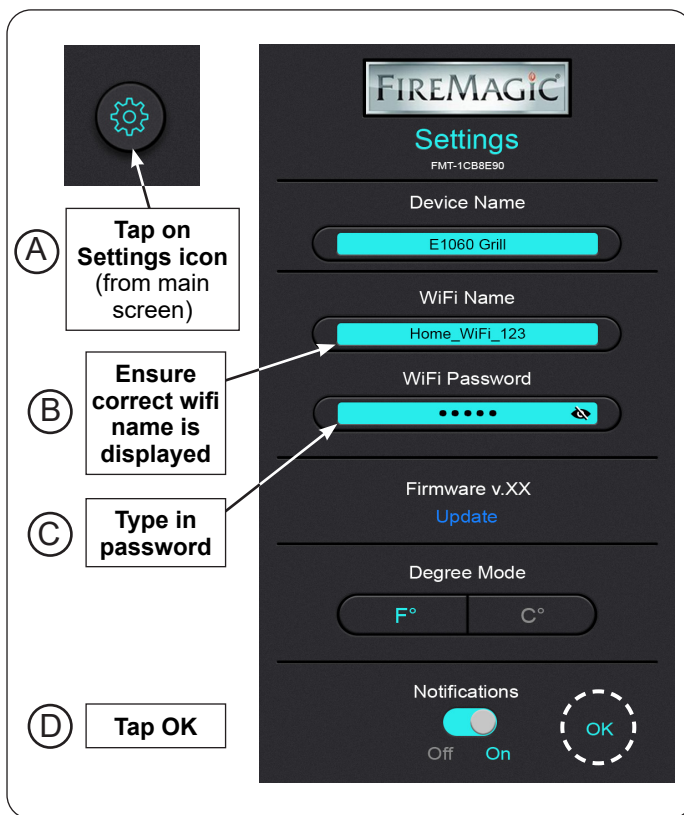

Fig. 8-1 Wifi setup

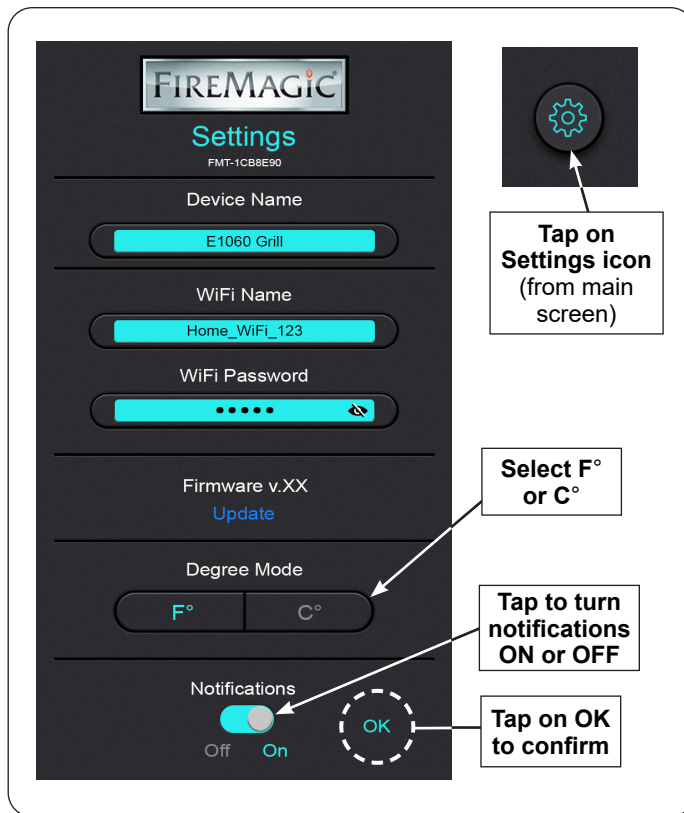

Fig. 8-2 Degree Mode & Notifications

APP OPERATING INSTRUCTIONS (Cont.)

ADDING, EDITING, DELETING A NEW ZONE OR DEVICE

- To add a new zone or device, tap the **+** icon found on the top right of your screen (see Fig. 9-1 or Fig. 9-2).
- To delete a zone or device, slide your finger across the desired unit, and tap **"Delete"** (see Fig. 9-1 or Fig. 9-2).
- To edit an existing zone, slide your finger across the desired zone, and tap **"Edit"** (see Fig. 9-1).

LOGGING OUT

To log out, simply click on the **Logout** icon and then tap **Yes** (see Fig. 9-3). To prevent unwanted use, it is recommended to log out after device is turned off.



Fig. 9-1 Add/Edit/Delete Zone

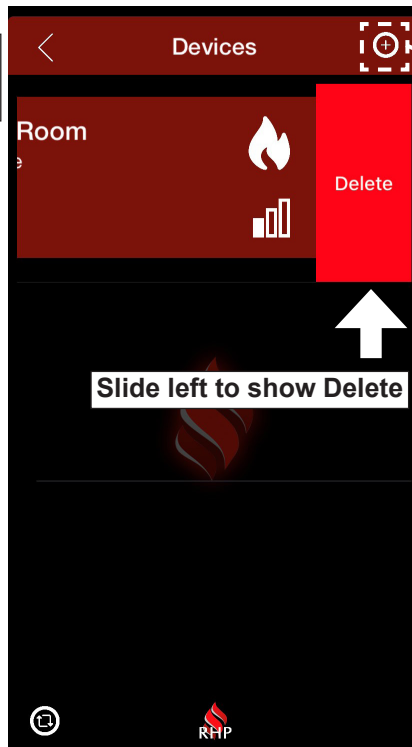

Fig. 9-2 Add/Delete Device

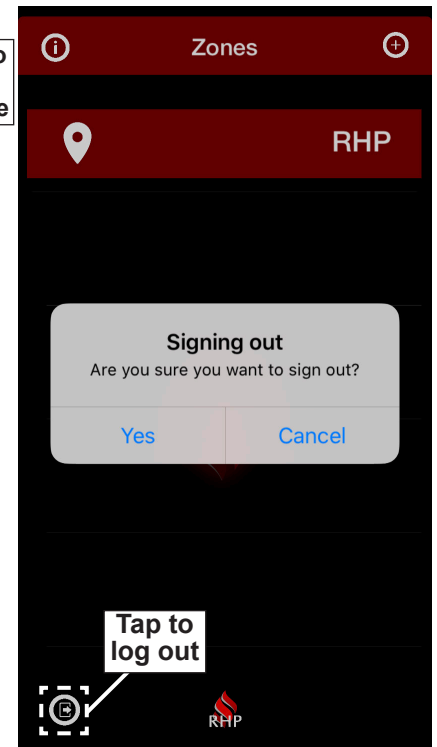

Fig. 9-3 Logging out

FORGOT PASSWORD

Select **"Forgot password"** on the home screen. Then follow the prompts on your screen to update your password. See Fig. 9-2 through Fig. 9-4 for details.

- You will receive an e-mail with a confirmation code; please check junk/spam folders in case the e-mail gets blocked.

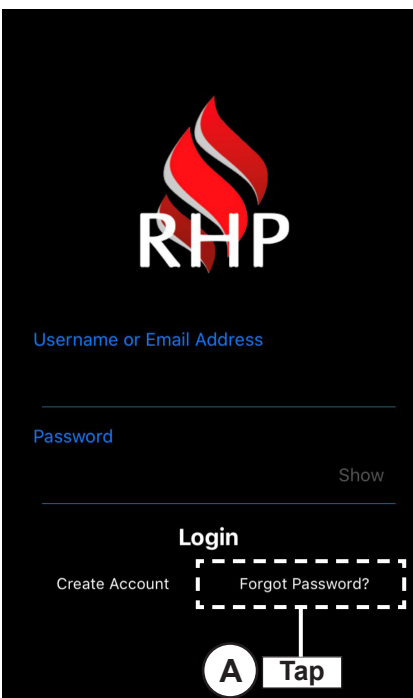

Fig. 9-2 Select forgot password

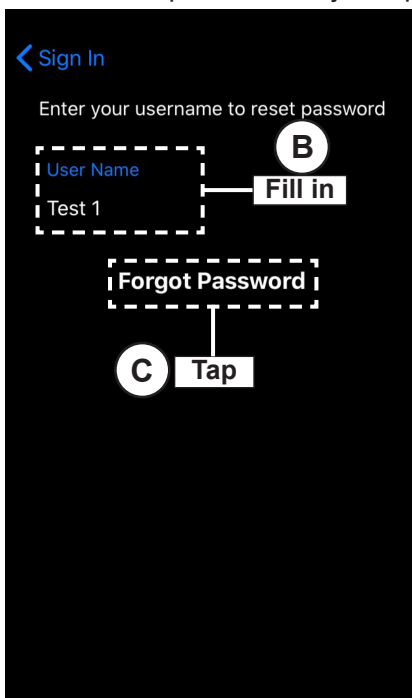

Fig. 9-3 Fill out screen

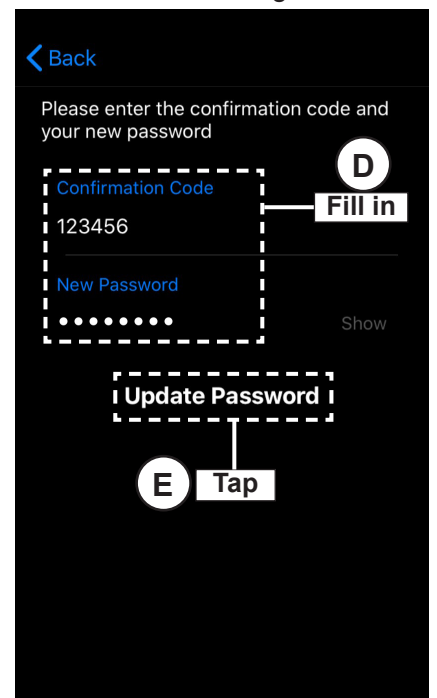

Fig. 9-4 Update password

TROUBLESHOOTING

If you are having trouble while using the app, see below to identify the problem.

PROBLEM	POSSIBLE CAUSE	CORRECTION
Digital display does not work	<ol style="list-style-type: none"> 1. Thermometer power switch not on 2. Electronic device out of range of grill 3. App not paired with grill 4. Faulty thermometer/thermostat control 5. Power failure 6. Power not connected properly 	<ol style="list-style-type: none"> 1. Ensure thermometer power switch on control panel is on (and light is illuminated). 2. Ensure device is within 30 feet (bluetooth) or within the wifi signal range. 3. Pair device. Refer to the ADD YOUR DEVICE section for details. 4. Check/replace thermometer/thermostat control. 5. Check if power is available. 6. Make sure the power source and powering equipment is properly connected and tested.
Digital display does not respond to electronic device	<ol style="list-style-type: none"> 1. App not paired with grill 2. App update needed 3. Thermometer/thermostat firmware update needed 4. Electronic device out of range of grill 5. Bluetooth or wifi disconnected 6. Unable to use the app 7. Faulty thermometer/thermostat control 	<ol style="list-style-type: none"> 1. Pair device. Refer to ADD YOUR DEVICE section for details. 2. Check in the app store for any updates and follow the prompts. 3. Update firmware via the app. Refer to the FIRMWARE UPDATE section for details. 4. Ensure device is within 30 feet (bluetooth) or within the wifi signal range (if setup to wifi). 5. Reconnect bluetooth or wifi on your electronic device. 6. If the app is not working, turn off the digital thermometer by pressing the thermometer power switch, or you may continue to operate the digital thermometer manually using the grill's touch controls. Reinstall the app or call support. 7. Check/replace thermometer/thermostat control.
Error code: Err	<ol style="list-style-type: none"> 1. Thermocouple failure 	<ol style="list-style-type: none"> 1. Thermocouple disconnected or faulty. Check connection or replace if faulty.

TECHNICAL APP ISSUES

If you need assistance on a technical issue related to the app (log in, connectivity, etc.), please e-mail the app support department support@app-assist.com or call (833) 437-8783. You may also tap on the support icon from the Zones screen (see Fig. 10-1) to call support directly from the app.

GAS GRILL ISSUES

If you are having trouble with the operation of the grill, see the TROUBLESHOOTING section of the manual included with your grill.

If the information on this page does not resolve your issue, please contact your local dealer, e-mail our general support department: support@rhpeterson.com, or visit our web site at www.rhpeterson.com.

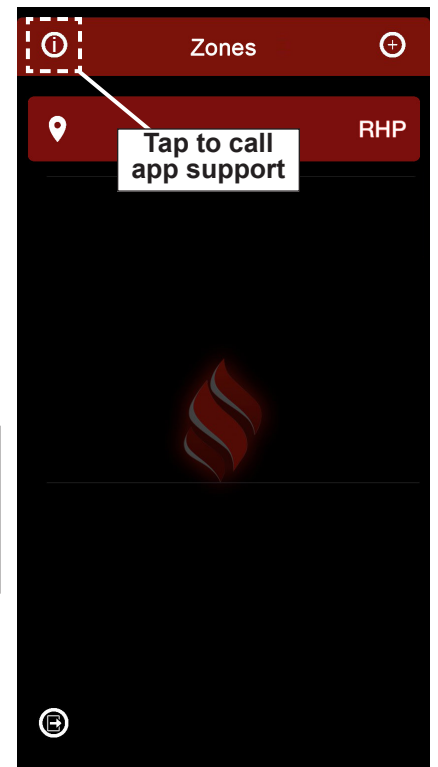

Fig. 10-1 Call support

NOTES

Please use this page to record any information that you may want to have at hand.