

Alfresco™

Open Air Culinary Systems

AXEDSP-42H PARTS LIST

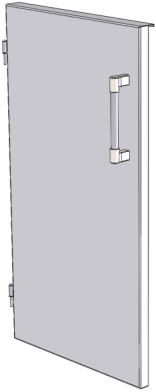

LEFT DOOR
510-1219



DOOR SEAL LT
130-2907

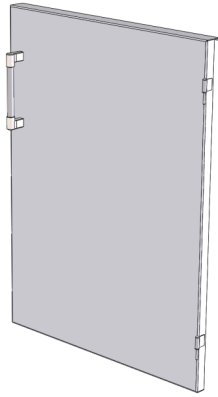

RIGHT DOOR
510-1220



DOOR SEAL RT
130-2908

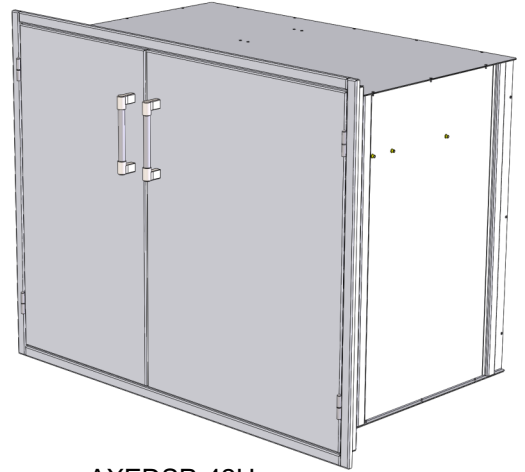

AXEDSP-42H

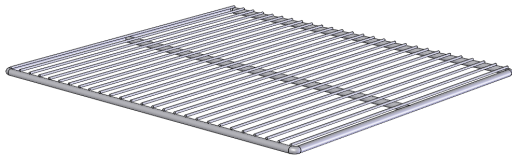

WIRE RACK
230-0031

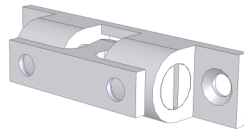

DOOR CATCH
290-0396

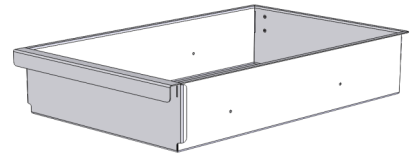

DRAWER 130-2903

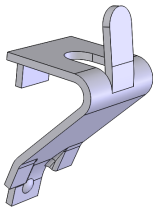

SHELF CLIP
290-0191

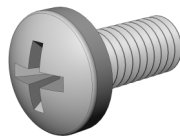

SCREW 200-0100
SLIDE TO BODY



DRAWER SLIDES
290-0282

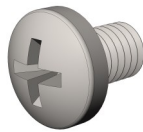

SCREW 200-0083
SLIDE TO DRAWER

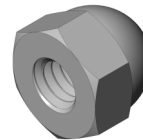

NUT 200-0351
SLIDE TO DRAWER